

GENIUS®

Made for Life



Impact Sockets

pg 2

Hand Sockets

pg 10

Screwdrivers & Bits

pg 26

Air Tools

pg 45

Wrenches

pg 49

Striking Tools

pg 56

Automotive Tools

pg 58

Tool Storage

pg 63

Trays & Master Sets

pg 65

Locking "C" Clamps NEW

ITEM NO.	Length
539606	150mm (6")
539611	280mm (11")
539618	460mm (18")
539624	610mm (24")

Locking Chain Pliers NEW

ITEM NO.	Length
538418	460mm (18")

Locking "C" Clamps with Swivel Pads NEW

ITEM NO.	Length
530306AR	150mm (6")
530311AR	280mm (11")
530318AR	460mm (18")
530324AR	610mm (24")

Claw-Grip Pliers NEW

ITEM NO.	Length
a. 536062	150mm (6")
b. 536064	150mm (6")

Pinch-Off Locking Pliers NEW

ITEM NO.	Length
a. 537807	180mm (7")
b. 537811	280mm (11")

1/4", 3/8" & 1/2" Dr. Ratchets & Hinge Handles w/ Rubber Grips

72 Teeth Rotor Ratchets NEW

ITEM NO.	Drive	Length
a. 281802S	1/4"	175mm
b. 381803S	3/8"	260mm
c. 481804S	1/2"	320mm

72 Teeth Flex Head Ratchets NEW

ITEM NO.	Drive	Length
a. 282262S	1/4"	205mm
b. 383363S	3/8"	270mm
c. 383338S	3/8"	320mm
d. 383383S*	3/8"	310mm
e. 484464S	1/2"	440mm
f. 484468S	1/2"	670mm

*Flex Head Ratchet w/ Bent Handle

Hinge Handles NEW

ITEM NO.	Drive	Length
a. 280226S	1/4"	185mm
b. 380336S	3/8"	240mm
c. 480446S	1/2"	420mm
d. 480448S	1/2"	640mm

Pliers

for more locking pliers or general pliers please turn to pg 55

BE-2343 3pcs Spinner Handle Set NEW

ITEM NO.	Drive	Hex Shank	Length
272065	1/4"	1/4"	65mm
273065	3/8"	1/4"	65mm
274065	1/2"	1/4"	65mm

Impact Sockets

1/4" Dr. Impact Sockets

Metric Impact Sockets			Metric Deep Impact Sockets		
ITEM NO.	Size mm	Length mm	ITEM NO.	Size mm	Length mm
212503	3	25	215204	4	50
212504	4	25	2152045	4.5	50
2125045	4.5	25	215205	5	50
212505	5	25	2152055	5.5	50
2125055	5.5	25	215206	6	50
212506	6	25	215207	7	50
212507	7	25	215208	8	50
212508	8	25	215209	9	50
212509	9	25	215210	10	50
212510	10	25	215211	11	50
212511	11	25	215212	12	50
212512	12	25	215213	13	50
212513	13	25	215214	14	50
212514	14	25			

SAE Impact Sockets			SAE Deep Impact Sockets		
ITEM NO.	Size Inch	Length mm	ITEM NO.	Size Inch	Length mm
292504	1/8	25	295206	3/16	50
292506	3/16	25	295207	7/32	50
292507	7/32	25	295208	1/4	50
292508	1/4	25	295209	9/32	50
292509	9/32	25	295210	5/16	50
292510	5/16	25	295211	11/32	50
292511	11/32	25	295212	3/8	50
292512	3/8	25	295214	7/16	50
292514	7/16	25	295216	1/2	50
292516	1/2	25	295218	9/16	50
292518	9/16	25			

1/4" Dr. Accessories

A Impact Adapter				B Impact Universal Joint		
ITEM NO.	Female Drive	Male Drive	Length mm	ITEM NO.	Outside Diameter	Length mm
290030	1/4"	3/8"	25	700106	16mm	35

C Impact Bit Holders			D Impact Extension Bars		
ITEM NO.	Hex Shank	Length mm	ITEM NO.	Retention Device	Length mm (Inch)
263508	1/4"	35	210002	Ball	50mm (2")
263510	5/16"	35	210003	Ball	75mm (3")
			210004	Ball	100mm (4")
			210006	Ball	150mm (6")

1/4" Dr. Impact Socket Sets

TF-214M 14pcs Metric Impact Socket Set

14 1/4" Dr. Socket (212503 ~ 212514)

3 - 4 - 4.5 - 5 - 5.5 - 6 - 7 - 8 - 9 - 10 - 11 - 12 - 13 - 14mm

400g 40 Sets / 13 Kgs / 0.71 CUFT



1/4" Dr. Impact Socket Sets

TD-211M 11pcs Metric Deep Impact Socket Set

11 1/4" Dr. Deep Socket (215204 ~ 215213)

4 - 5 - 5.5 - 6 - 7 - 8 - 9 - 10 - 11 - 12 - 13mm

400g 20 Sets / 9 Kgs / 0.71 CUFT



TF-211S 11pcs SAE Impact Socket Set

11 1/4" Dr. Socket (292504 ~ 292518)

1/8 - 3/16 - 7/32 - 1/4 - 9/32 - 5/16 - 11/32 - 3/8 - 7/16 - 1/2 - 9/16"

260g 40 Sets / 12 Kgs / 0.71 CUFT



TD-210S 10pcs SAE Deep Impact Socket Set

10 1/4" Dr. Deep Socket (295206 ~ 295218)

3/16 - 7/32 - 1/4 - 9/32 - 5/16 - 11/32 - 3/8 - 7/16 - 1/2 - 9/16"

360g 20 Sets / 8 Kgs / 0.71 CUFT



TF-255MS 55pcs Metric & SAE Deep Impact Socket Set

14 1/4" Dr. Socket (212503 ~ 212514)

3 - 4 - 4.5 - 5 - 5.5 - 6 - 7 - 8 - 9 - 10 - 11 - 12 - 13 - 14mm

13 1/4" Dr. Deep Socket (215204 ~ 215214)

4 - 4.5 - 5 - 5.5 - 6 - 7 - 8 - 9 - 10 - 11 - 12 - 13 - 14mm

11 1/4" Dr. Socket (292504 ~ 292518)

1/8 - 3/16 - 7/32 - 1/4 - 9/32 - 5/16 - 11/32 - 3/8 - 7/16 - 1/2 - 9/16"

10 1/4" Dr. Deep Socket (295206 ~ 295218)

3/16 - 7/32 - 1/4 - 9/32 - 5/16 - 11/32 - 3/8 - 7/16 - 1/2 - 9/16"

1 1/4" Dr. Adapter 1/4" F x 3/8" M (290030)

1 1/4" Dr. Universal Joint (700106)

1 1/4" Dr. Bit Holder (263508)

4 1/4" Dr. Extension (210002 ~ 210006)

50 - 75 - 100 - 150mmL

1760g 12 Sets / 22 Kgs / 1.16 CUFT



IE-2349 9pcs Impact Extension Bar Set

3 1/4" Dr. Ext. (21002 ~ 21006)

50 - 100 - 150mmL

3 3/8" Dr. Ext. (380005 ~ 380036)

45 - 75 - 150mmL

3 1/2" Dr. Ext. (480002 ~ 480320)

50 - 125 - 250mmL

1/6 Tray 1170g 10 Sets / 13 Kgs / 0.93 CUFT



3/8" Dr. Impact Sockets

6 pt. Metric Impact Sockets



ITEM NO.	Size mm	Length mm
343207	7	28
343208	8	28
343209	9	28
343210	10	28
343211	11	30
343212	12	30
343213	13	30
343214	14	30
343215	15	30
343216	16	30
343217	17	32
343218	18	32
343219	19	32
343220	20	32
343221	21	32
343222	22	32

6 pt. Metric Deep Impact Sockets



ITEM NO.	Size mm	Length mm
346307	7	63
346308	8	63
346309	9	63
346310	10	63
346311	11	63
346312	12	63
346313	13	63
346314	14	63
346315	15	63
346316	16	63
346317	17	63
346318	18	63
346319	19	63
346320	20	63
346321	21	63
346322	22	63

6 pt. SAE Impact Sockets



ITEM NO.	Size Inch	Length mm
363210	5/16	28
363211	11/32	28
363212	3/8	28
363214	7/16	30
363216	1/2	30
363218	9/16	30
363219	19/32	30
363220	5/8	30
363222	11/16	32
363224	3/4	32
363225	25/32	32
363226	13/16	32
363228	7/8	32

6 pt. SAE Deep Impact Sockets



ITEM NO.	Size Inch	Length mm
366310	5/16	63
366311	11/32	63
366312	3/8	63
366314	7/16	63
366316	1/2	63
366318	9/16	63
366319	19/32	63
366320	5/8	63
366322	11/16	63
366324	3/4	63
366325	25/32	63
366326	13/16	63
366328	7/8	63

3/8" Dr. Accessories

A Impact Adapters



ITEM NO.	Female Drive	Male Drive	Retention Device	Length mm
340040	3/8"	1/2"	Pin	35
340040B	3/8"	1/2"	Ball	35
340020	3/8"	1/4"	Ball	30

B Impact Universal Joint



ITEM NO.	Outside Diameter	Length mm
700107	26mm	65

C Impact Bit Holders



ITEM NO.	Hex Shank	Length mm
364608	1/4"	46
363908	1/4"	39
364610	5/16"	46
363910	5/16"	39

D Impact Extension Bars



ITEM NO.	Retention Device	Length mm (Inch)
340075	Pin	75mm (3")
340075B	Ball	75mm (3")
340125	Pin	125mm (5")
340125B	Ball	125mm (5")
340200	Pin	200mm (8")
340200B	Ball	200mm (8")

3/8" Dr. Impact Socket Sets

CM-316M 16pcs Metric Impact Socket Set

16 3/8" Dr. Socket (343207 ~ 343222)
7 - 8 - 9 - 10 - 11 - 12 - 13 - 14 - 15 - 16 - 17 - 18 - 19 - 20 - 21 - 22mm

1170g 20 Sets / 24.5 Kgs / 0.73 CUFT



3/8" Dr. Impact Socket Sets

Deep CM-316MD 16pcs Metric Deep Impact Socket Set

16 3/8" Dr. Socket (346307 ~ 346322)
7 - 8 - 9 - 10 - 11 - 12 - 13 - 14 - 15 - 16 - 17 - 18 - 19 - 20 - 21 - 22mm

2400g 12 Sets / 30 Kgs / 0.73 CUFT



Deep CM-332M 32pcs Metric Deep Impact Socket Set

16 3/8" Dr. Socket (343207 ~ 343222)
7 - 8 - 9 - 10 - 11 - 12 - 13 - 14 - 15 - 16 - 17 - 18 - 19 - 20 - 21 - 22mm
16 3/8" Dr. Deep Socket (346307 ~ 346322)
7 - 8 - 9 - 10 - 11 - 12 - 13 - 14 - 15 - 16 - 17 - 18 - 19 - 20 - 21 - 22mm

3450g 5 Sets / 18 Kgs / 0.93 CUFT



CM-313S 13pcs SAE Impact Socket Set

13 3/8" Dr. Socket (363210 ~ 363228)
5/16 - 11/32 - 3/8 - 7/16 - 1/2 - 9/16 - 19/32 - 5/8 - 11/16 - 3/4 - 25/32 - 13/16 - 7/8"

1000g 20 Sets / 21 Kgs / 0.73 CUFT



Deep CM-313SD 13pcs SAE Deep Impact Socket Set

13 3/8" Dr. Deep Socket (366310 ~ 366328)
5/16 - 11/32 - 3/8 - 7/16 - 1/2 - 9/16 - 19/32 - 5/8 - 11/16 - 3/4 - 25/32 - 13/16 - 7/8"

2100g 12 Sets / 26 Kgs / 0.73 CUFT



Deep CM-326S 26pcs SAE Deep Impact Socket Set

13 3/8" Dr. Socket (363210 ~ 363228)
5/16 - 11/32 - 3/8 - 7/16 - 1/2 - 9/16 - 19/32 - 5/8 - 11/16 - 3/4 - 25/32 - 13/16 - 7/8"
13 3/8" Dr. Deep Socket (366310 ~ 366328)
5/16 - 11/32 - 3/8 - 7/16 - 1/2 - 9/16 - 19/32 - 5/8 - 11/16 - 3/4 - 25/32 - 13/16 - 7/8"

3400g 5 Sets / 18 Kgs / 0.63 CUFT



3/8" Dr. Swivel Impact Socket Sets

TG-312M 12pcs Metric Swivel Impact Socket Set

12 3/8" Dr. Swivel Socket (380008M ~ -19M)
8 - 9 - 10 - 11 - 12 - 13 - 14 - 15 - 16 - 17 - 18 - 19mm

1270g 12 Sets / 16.5 Kgs / 0.73 CUFT



Deep TG-312MD 12pcs Metric Deep Swivel Impact Socket Set

12 3/8" Dr. Deep Swivel Socket (380008MD ~ -19MD)
8 - 9 - 10 - 11 - 12 - 13 - 14 - 15 - 16 - 17 - 18 - 19mm

2690g 8 Sets / 23 Kgs / 0.69 CUFT



TG-308S 8pcs SAE Swivel Impact Socket Set

8 3/8" Dr. Swivel Socket (380021 ~ -28)
5/16 - 3/8 - 7/16 - 1/2 - 9/16 - 5/8 - 11/16 - 3/4"

780g 12 Sets / 10.5 Kgs / 0.73 CUFT



Deep TG-308SD 8pcs SAE Deep Swivel Impact Socket Set

8 3/8" Dr. Deep Swivel Socket (380021D ~ -28D)
5/16 - 3/8 - 7/16 - 1/2 - 9/16 - 5/8 - 11/16 - 3/4"

1830g 12 Sets / 23 Kgs / 0.69 CUFT



Impact Sockets

1/2" Dr. Impact Sockets

6 pt. Metric Impact Sockets



ITEM NO.	Size mm	Length mm
444008	8	38
444009	9	38
444010	10	38
444011	11	38
444012	12	38
444013	13	38
444014	14	38
444015	15	38
444016	16	38
444017	17	38
444018	18	38
444019	19	40
444020	20	40
444021	21	40
444022	22	42
444023	23	42
444024	24	44
444025	25	44
444026	26	44
444027	27	46
444028	28	46
444029	29	46
444030	30	46
444031	31	46
444032	32	46
444033	33	46
444034	34	46
444035	35	48
444036	36	48
444038	38	48
444039	39	50
444040	40	55
444041	41	55

6 pt. Metric Deep Impact Sockets



ITEM NO.	Size mm	Length mm
447808	8	78
447809	9	78
447810	10	78
447811	11	78
447812	12	78
447813	13	78
447814	14	78
447815	15	78
447816	16	78
447817	17	78
447818	18	78
447819	19	78
447820	20	78
447821	21	78
447822	22	78
447823	23	78
447824	24	78
447825	25	78
447826	26	78
447827	27	78
447828	28	78
447829	29	78
447830	30	78
447831	31	78
447832	32	78
447833	33	78
447834	34	78
447835	35	78
447836	36	78
447838	38	78

6 pt. SAE Impact Sockets



ITEM NO.	Size Inch	Length mm
464010	5/16	38
464012	3/8	38
464014	7/16	38
464016	1/2	38
464018	9/16	38
464019	19/32	38
464020	5/8	38
464022	11/16	38
464024	3/4	40
464025	25/32	40
464026	13/16	40
464028	7/8	42
464030	15/16	44
464032	1	44
464034	1-1/16	46
464036	1-1/8	46
464038	1-3/16	46
464040	1-1/4	46
464042	1-5/16	46
464044	1-3/8	48
464046	1-7/16	48
464048	1-1/2	48

6 pt. SAE Deep Impact Sockets



ITEM NO.	Size Inch	Length mm
467810	5/16	78
467812	3/8	78
467814	7/16	78
467816	1/2	78
467818	9/16	78
467819	19/32	78
467820	5/8	78
467822	11/16	78
467824	3/4	78
467825	25/32	78
467826	13/16	78
467828	7/8	78
467830	15/16	78
467832	1	78
467834	1-1/16	78
467836	1-1/8	78
467838	1-3/16	78
467840	1-1/4	78
467842	1-5/16	78
467844	1-3/8	78
467846	1-7/16	78
467848	1-1/2	78

1/2" Dr. Impact Sockets

12 pt. Metric Thin Wall Impact Sockets



ITEM NO.	Size mm	Length mm
453808	8	38
453809	9	38
453810	10	38
453811	11	38
453812	12	38
453813	13	38
453814	14	38
453815	15	38
453816	16	38
453817	17	38
453818	18	38
453819	19	40
453820	20	40
453821	21	40
453822	22	42
453823	23	42
453824	24	44
453825	25	44
453826	26	44
453827	27	46
453828	28	46
453829	29	46
453830	30	46
453831	31	46
453832	32	46
453833	33	46
453834	34	46
453835	35	48
453836	36	48
453837	37	48
453838	38	48
453839	39	50
453840	40	55
453841	41	55

12 pt. Metric Deep Thin Wall Impact Sockets



ITEM NO.	Size mm	Length mm
448508	8	85
448509	9	85
448510	10	85
448511	11	85
448512	12	85
448513	13	85
448514	14	85
448515	15	85
448516	16	85
448517	17	85
448518	18	85
448519	19	85
448520	20	85
448521	21	85
448522	22	85
448523	23	85
448524	24	85
448530	30	85
448536	36	85

NEW 6 pt. SAE Extra-Thin Wall Flip Impact Sockets



ITEM NO.	Size Hex	Size Hex mm	Length mm
49762426	13/16"	3/4"	76

6 pt. Extra-Deep Impact Sockets



ITEM NO.	Size mm	Length mm
4412711	11mm	127
4412715	15mm	127
4612716	1/2"	127
4612720	5/8"	127
4612722	11/16"	127

1/2" Dr. Accessories

A Impact Adapters



ITEM NO.	Female Drive	Male Drive	Retention Device	Length mm
480033CM	1/2"	3/8"	Pin	38
480033MB	1/2"	3/8"	Ball	38
480066CM	1/2"	3/4"	Pin	41
480066MB	1/2"	3/4"	Ball	41

B Impact Universal Joint



ITEM NO.	Outside Diameter mm	Length mm
700108	28mm	70

C Impact Bit Holders



ITEM NO.	Hex Shank	Length mm
464808	1/4"	48
464108	1/4"	41
464810	5/16"	48
464110	5/16"	41

D Impact Extension Bars



ITEM NO.	Retention Device	Length mm (Inch)
480032CM	Pin	75mm (3")
480032MB	Ball	75mm (3")
480036CM	Pin	125mm (5")
480036MB	Ball	125mm (5")
480250CM	Pin	250mm (10")
480250MB	Ball	250mm (10")

1/2" Dr. Impact Socket Sets

IS-425M 25pcs Metric Impact Socket Set

25 1/2" Dr. Socket (444008 ~ 444036)
8 - 9 - 10 - 11 - 12 - 13 - 14 -
15 - 16 - 17 - 18 - 19 - 20 - 21 -
22 - 23 - 24 - 25 - 26 - 27 - 28 -
29 - 30 - 32 - 36mm

4000g 3 Sets / 13 Kgs / 0.82 CUFT



CD-415M 13pcs Metric Deep Impact Socket Set

13 1/2" Dr. Deep Socket (447810 ~ 447830)
10 - 11 - 12 - 13 - 14 - 16 - 17 -
19 - 21 - 22 - 24 - 27 - 30mm

4500g 4 Sets / 19 Kgs / 0.43 CUFT



DI-425M 25pcs Metric Deep Impact Socket Set

25 1/2" Dr. Deep Socket (447808 ~ -36)
8 - 9 - 10 - 11 - 12 - 13 - 14 -
15 - 16 - 17 - 18 - 19 - 20 - 21 -
22 - 23 - 24 - 25 - 26 - 27 - 28 -
29 - 30 - 32 - 36mm

7000g 3 Sets / 22 Kgs / 0.82 CUFT



GS-440M 40pcs Master Metric Deep Impact Socket Set

19 1/2" Dr. Socket (444009 ~ 444030)
9 - 10 - 11 - 12 - 13 - 14 - 15 - 16 -
17 - 18 - 19 - 20 - 21 - 22 - 23 - 24 -
26 - 27 - 30mm

19 1/2" Dr. Deep Socket (447809 ~ 447830)
9 - 10 - 11 - 12 - 13 - 14 - 15 - 16 -
17 - 18 - 19 - 20 - 21 - 22 - 23 - 24 -
26 - 27 - 30mm

1 1/2" Dr. Universal Joint (700108)
1 1/2" Dr. Extension 125mmL (480036MB)

8000g 3 Sets / 25 Kgs / 1.16 CUFT



IS-422S 22pcs SAE Impact Socket Set

22 1/2" Dr. Impact Socket (464010 ~ 464048)
5/16 - 3/8 - 7/16 - 1/2 - 9/16 -
19/32 - 5/8 - 11/16 - 3/4 - 25/32 -
13/16 - 7/8 - 15/16 - 1" - 1 1/16 -
1 1/8 - 1 3/16 - 1 1/4 - 1 5/16 -
1 3/8 - 1 7/16 - 1 1/2"

4330g 3 Sets / 14 Kgs / 0.82 CUFT



CM-031 13pcs SAE Deep Impact Socket Set

13 1/2" Dr. Deep Socket (467814 ~ 467840)
7/16 - 1/2 - 9/16 - 5/8 - 11/16 -
3/4 - 13/16 - 7/8 - 15/16 - 1" -
1 1/16 - 1 1/8 - 1 1/4"

4500g 4 Sets / 19 Kgs / 0.43 CUFT



DI-422S 22pcs SAE Deep Impact Socket Set

22 1/2" Dr. Socket (467810 ~ 467848)
5/16 - 3/8 - 7/16 - 1/2 - 9/16 -
19/32 - 5/8 - 11/16 - 3/4 - 25/32 -
13/16 - 7/8 - 15/16 - 1" - 1 1/16 -
1 1/8 - 1 3/16 - 1 1/4 - 1 5/16 -
1 3/8 - 1 7/16 - 1 1/2"

6700g 3 Sets / 21 Kgs / 0.82 CUFT



3/8" & 1/2" Dr. Swivel Impact Sockets are available individually. Please contact us for more details.

1/2" Dr. Impact Socket Sets

GS-434S 34pcs Master SAE Deep Impact Socket Set

16 1/2" Dr. Socket (464010 ~ 464040)
5/16 - 3/8 - 7/16 - 1/2 - 9/16 - 5/8 -
11/16 - 3/4 - 13/16 - 7/8 - 15/16 - 1" -
1 1/16 - 1 1/8 - 1 3/16 - 1 1/4"

16 1/2" Dr. Deep Socket (467810 ~ 467840)
5/16 - 3/8 - 7/16 - 1/2 - 9/16 - 5/8 -
11/16 - 3/4 - 13/16 - 7/8 - 15/16 - 1" -
1 1/16 - 1 1/8 - 1 3/16 - 1 1/4"

1 1/2" Dr. Universal Joint (700108)
1 1/2" Dr. Extension (480036MB) 125mmL

7500g 3 Sets / 23.5 Kgs / 1.16 CUFT



1/2" Dr. Swivel Impact Socket Sets

TG-411M 11pcs Metric Swivel Impact Socket Set

11 1/2" Dr. Swivel Socket
(480011M ~ 480022M)
11 - 12 - 13 - 14 - 15 - 16 - 17 -
18 - 19 - 21 - 22mm

2260g 12 Sets / 28 Kgs / 0.70 CUFT



TG-411MD 11pcs Metric Deep Swivel Impact Socket Set

11 1/2" Dr. Deep Swivel Socket
(480011MD ~ 480022MD)
11 - 12 - 13 - 14 - 15 - 16 - 17 -
18 - 19 - 21 - 22mm

3250g 8 Sets / 27.5 Kgs / 0.73 CUFT



TG-408S 8pcs SAE Swivel Impact Socket Set

8 1/2" Dr. Swivel Socket
(480024 ~ 480031)
7/16 - 1/2 - 9/16 - 5/8 - 11/16 -
3/4 - 13/16 - 7/8"

1710g 12 Sets / 22 Kgs / 0.70 CUFT



TG-408SD 8pcs SAE Deep Swivel Impact Socket Set

8 1/2" Dr. Swivel Socket
(480024D ~ 480031D)
7/16 - 1/2 - 9/16 - 5/8 - 11/16 -
3/4 - 13/16 - 7/8"

2350g 8 Sets / 20.5 Kgs / 0.70 CUFT



1/2" Dr. Thin Wall Impact Socket Sets

GS-415M 15pcs Metric Thin Wall Impact Socket Set

15 1/2" Dr. Thin Wall Socket (453810 ~ 453824)
10 - 11 - 12 - 13 - 14 - 15 - 16 -
17 - 18 - 19 - 20 - 21 - 22 - 23 -
24mm

1400g 10 Sets / 16 Kgs / 0.60 CUFT



DI-417MD 17pcs Metric Deep Thin Wall Impact Socket Set

11 1/2" Dr. Deep Thin Wall Socket
(448508 ~ 448524)
8 - 9 - 10 - 11 - 12 - 13 - 14 -
15 - 16 - 17 - 18 - 19 - 20 -
21 - 22 - 23 - 24mm

3340g 5 Sets / 18 Kgs / 0.93 CUFT



Impact Sockets

3/4" Dr. Impact Sockets

6 pt. Metric Impact Sockets



ITEM NO.	Size mm	Length mm
645217	17	51
645218	18	51
645219	19	51
645220	20	51
645221	21	51
645222	22	51
645223	23	51
645224	24	51
645225	25	54
645226	26	54
645227	27	54
645228	28	54
645229	29	54
645230	30	54
645231	31	54
645232	32	57
645233	33	57
645234	34	57
645235	35	57
645236	36	57
645237	37	57
645238	38	57
645239	39	58
645240	40	58
645241	41	58
645242	42	60
645243	43	60
645244	44	63
645245	45	63
645246	46	63
645247	47	65
645248	48	65
645249	49	65
645250	50	68
645251	51	68
645252	52	70
645253	53	70
645254	54	73
645255	55	73
645256	56	73
645257	57	73
645258	58	73
645259	59	73
645260	60	80
645263	63	80
645265	65	85
645270	70	90

6 pt. Metric Deep Impact Sockets



ITEM NO.	Size mm	Length mm
649517	17	90
649518	18	90
649519	19	90
649520	20	90
649521	21	90
649522	22	90
649523	23	90
649524	24	90
649525	25	90
649526	26	90
649527	27	90
649528	28	90
649529	29	90
649530	30	90
649532	32	90
649533	33	90
649534	34	90
649535	35	90
649536	36	90
649538	38	90
649540	40	90
649541	41	90
649542	42	90
649543	43	90
649545	45	95
649546	46	95
649548	48	100
649550	50	100

6 pt. SAE Deep Impact Sockets



ITEM NO.	Size Inch	Length mm
669522	11/16	90
669524	3/4	90
669525	25/32	90
669526	13/16	90
669528	7/8	90
669530	15/16	90
669532	1	90
669534	1-1/16	90
669534T*	1-1/16	90
669536	1-1/8	90
669536T*	1-1/8	90
669538	1-3/16	90
669540	1-1/4	90
669540T*	1-1/4	90
669542	1-5/16	90
669544	1-3/8	90
669546	1-7/16	90
669548	1-1/2	90
669550	1-9/16	90
669552	1-5/8	90
669554	1-11/16	90
669556	1-3/4	95
669558	1-13/16	95
669560	1-7/8	100
669562	1-15/16	100
669564	2	100

6 pt. SAE Impact Sockets



ITEM NO.	Size Inch	Length mm
665222	11/16	51
665224	3/4	51
665225	25/32	51
665226	13/16	51
665228	7/8	51
665230	15/16	51
665232	1	54
665234	1-1/16	54

continued on next column...

* Thin Wall Sockets

3/4" Dr. Impact Sockets

6 pt. SAE Impact Sockets



ITEM NO.	Size Inch	Length mm
665236	1-1/8	54
665238	1-3/16	54
665240	1-1/4	57
665242	1-5/16	57
665244	1-3/8	57
665246	1-7/16	57
665248	1-1/2	57
665250	1-9/16	58
665252	1-5/8	58
665254	1-11/16	60
665256	1-3/4	63
665258	1-13/16	63
665260	1-7/8	65
665262	1-15/16	65
665264	2	68
665266	2-1/16	70
665268	2-1/8	73
665270	2-3/16	73
665272	2-1/4	73
665274	2-5/16	73
665276	2-3/8	80
665280	2-1/2	80
665284	2-5/8	85
665288	2-3/4	90

12 pt. SAE Thin Wall Impact Sockets



ITEM NO.	Size Inch	Length mm
695222	11/16	51
695224	3/4	51
695225	25/32	51
695226	13/16	51
695228	7/8	51
695230	15/16	51
695232	1	54
695234	1-1/16	54
695236	1-1/8	54
695238	1-3/16	54
695240	1-1/4	57
695242	1-5/16	57
695244	1-3/8	57
695246	1-7/16	57
695248	1-1/2	57
695250	1-9/16	58
695252	1-5/8	58
695254	1-11/16	60
695256	1-3/4	63
695258	1-13/16	63
695260	1-7/8	65
695262	1-15/16	65
695264	2	68
695266	2-1/16	70
695268	2-1/8	73
695270	2-3/16	73
695272	2-1/4	73
695274	2-5/16	73
695276	2-3/8	80
695280	2-1/2	80
695284	2-5/8	85
695288	2-3/4	90

12 pt. Metric Thin Wall Impact Sockets



ITEM NO.	Size mm	Length mm
655217	17	51
655218	18	51
655219	19	51
655220	20	51
655221	21	51
655222	22	51
655223	23	51
655224	24	51
655225	25	54
655226	26	54
655227	27	54
655228	28	54
655229	29	54
655230	30	54
655231	31	54
655232	32	57
655233	33	57
655234	34	57
655235	35	57
655236	36	57
655237	37	57
655238	38	57
655239	39	58
655240	40	58
655241	41	58
655242	42	58
655243	43	60
655244	44	63
655245	45	63
655246	46	63
655247	47	63
655248	48	65
655249	49	65
655250	50	68
655251	51	68
655252	52	70
655253	53	70
655254	54	73
655255	55	73
655256	56	73
655257	57	73
655258	58	73
655259	59	73
655260	60	80
655263	63	80
655265	65	85
655270	70	90

3/4" Dr. Accessories

A Impact Adapters

ITEM NO.	Female Drive	Male Drive	Retention Device	L mm
640604	3/4"	1/2"	Pin	63
640604B	3/4"	1/2"	Ball	63
640608	3/4"	1"	Pin	65
640608B	3/4"	1"	Bal	65

C Impact Extension Bars

ITEM NO.	Retention Device	Length mm (Inch)
640100	Pin	100mm (4")
640100B	Ball	100mm (4")
640150	Pin	150mm (6")
640150B	Ball	150mm (6")
640200	Pin	200mm (8")
640200B	Ball	200mm (8")
640250	Pin	250mm (10")
640250B	Ball	250mm (10")

B Impact Universal Joints

ITEM NO.	Retention Device	Outside Diameter mm	Length mm
640606	Pin	44 mm	110
640606B	Ball	44 mm	110

3/4" Dr. Impact Socket Sets

CM-022 8pcs Metric Impact Socket Set

8 3/4" Dr. Socket (645226 ~ 645238)
26 - 27 - 29 - 30 - 32 - 35 - 36 - 38mm



6 pt.

4160g 6 Sets / 26 Kgs / 0.62 CUFT

IS-609E 9pcs Metric Impact Socket Set

9 3/4" Dr. Socket (645219 ~ 645236)
19 - 22 - 24 - 27 - 30 - 32 - 33 - 34 - 36mm



6 pt.

4000g 4 Sets / 17 Kgs / 0.85 CUFT

IS-617E 17pcs Metric Impact Socket Set

17 3/4" Dr. Socket (645219 ~ 645255)
19 - 21 - 22 - 24 - 27 - 30 - 32 - 33 - 34 - 35 - 36 - 38 - 40 - 41 - 46 - 50 - 55mm



6 pt.

9800g 2 Sets / 20.5 Kgs / 0.92 CUFT

IS-627M 27pcs Metric Impact Socket Set

27 3/4" Dr. Impact Socket (645217 ~ 645260)
17 - 19 - 20 - 21 - 22 - 23 - 24 - 27 - 30 - 31 - 32 - 33 - 34 - 35 - 36 - 37 - 38 - 40 - 41 - 45 - 46 - 48 - 50 - 54 - 55 - 57 - 60mm



6 pt.

18500g 1 Sets / 19 Kgs / 1.40 CUFT

CM-023M2 8pcs Metric Deep Impact Socket Set

8 3/4" Dr. Deep Socket (649526 ~ 649538)
26 - 27 - 29 - 30 - 32 - 35 - 36 - 38mm



6 pt.

6750g 4 Sets / 28 Kgs / 0.62 CUFT

IS-609DE 9pcs Metric Deep Impact Socket Set

9 3/4" Dr. Deep Socket (649519 ~ 649536)
19 - 22 - 24 - 27 - 30 - 32 - 33 - 34 - 36mm



6 pt.

6600g 3 Sets / 21 Kgs / 1.12 CUFT

3/4" Dr. Impact Socket Sets

CM-021 8pcs SAE Impact Socket Set

8 3/4" Dr. Socket (665232 ~ 665248)
1" - 1 1/16 - 1 1/8 - 1 1/4 - 1 5/16 - 1 3/8 - 1 7/16 - 1 1/2"



6 pt.

4160g 6 Sets / 26 Kgs / 0.62 CUFT

IS-617S 17pcs SAE Impact Socket Set

17 3/4" Dr. Socket (665232 ~ 665264)
1" - 1 1/16 - 1 1/8 - 1 3/16 - 1 1/4 - 1 5/16 - 1 3/8 - 1 7/16 - 1 1/2 - 1 9/16 - 1 11/16 - 1 3/4 - 1 13/16 - 1 7/8 - 1 15/16 - 2"



6 pt.

11000g 2 Sets / 23 Kgs / 0.92 CUFT

IS-627S 27pcs SAE Impact Socket Set

27 3/4" Dr. Impact Socket (665224 ~ 665276)
3/4 - 25/32 - 13/16 - 7/8 - 15/16 - 1" - 1 1/16 - 1 1/8 - 1 3/16 - 1 1/4 - 1 5/16 - 1 3/8 - 1 7/16 - 1 1/2 - 1 9/16 - 1 5/8 - 1 11/16 - 1 3/4 - 1 13/16 - 1 7/8 - 1 15/16 - 2" - 2 1/16 - 2 1/8 - 2 3/16 - 2 1/4 - 2 3/8"



6 pt.

20000g 1 Sets / 21 Kgs / 1.40 CUFT

CM-023-1 8pcs SAE Deep Impact Socket Set

8 3/4" Dr. Deep Socket (669532 ~ 669548)
1" - 1 1/16 - 1 1/8 - 1 1/4 - 1 5/16 - 1 3/8 - 1 7/16 - 1 1/2"



6 pt.

6750g 4 Sets / 28 Kgs / 0.62 CUFT

TR-611MS 11pcs Metric & SAE Truck Wheel Impact Socket Set

4 3/4" Dr. Deep Socket (649533 ~ 649541)
33 - 35 - 38 - 41mm

2 3/4" Dr. Deep Budd Wheel (649517S ~ 649521S)
17 - 21mm Square

3 3/4" Dr. Deep Thin Wall (669534T ~ 669540T)
1 1/16 - 1 1/8 - 1 1/4"

1 3/4" Dr. Deep Budd Wheel (669526S)
13/16" Square

1 3/4" Dr. Deep Budd Wheel (669548B)
1 1/2" Hex



6 pt.

8540g 2 Sets / 18 Kgs / 0.95 CUFT

Impact Sockets

1" Dr. Impact Sockets

6 pt. Metric Impact Sockets



ITEM NO.	Size mm	Length mm
847021	21	60
847022	22	60
847023	23	60
847024	24	60
847025	25	60
847026	26	60
847027	27	60
847028	28	60
847029	29	60
847030	30	62
847032	32	63
847033	33	63
847034	34	63
847035	35	63
847036	36	67
847038	38	67
847040	40	67
847041	41	70
847042	42	70
847043	43	70
847046	46	70
847048	48	70
847050	50	70
847052	52	82
847054	54	82
847055	55	87
847057	57	87
847058	58	87
847059	59	87
847060	60	91
847063	63	91
847065	65	95
847067	67	95
847070	70	100
847071	71	100
847075	75	105
847077	77	105
847080	80	105
847082	82	105
847085	85	110
847090	90	110
847095	95	110

6 pt. Metric Deep Impact Sockets



ITEM NO.	Size mm	Length mm
849519	19	90
849521	21	90
849522	22	90
849523	23	90
849524	24	90
849525	25	90
849526	26	90
849527	27	90
849528	28	90
849529	29	90
849530	30	90
849532	32	90
849533	33	90
849534	34	90
849535	35	90
849536	36	90
849538	38	90
849541	41	90
849542	42	90
849543	43	90
849546	46	100
849548	48	100
849550	50	100
849552	52	100
849554	54	100
849555	55	110
849557	57	110
849558	58	110
849559	59	110
849560	60	110
849563	63	120
849565	65	120
849570	70	125

1" Dr. Accessories

A Impact Adapters

ITEM NO.	Female Drive	Male Drive	Retention Device	L mm
841006	1"	3/4"	Pin	70
841006B	1"	3/4"	Ball	70
841012	1"	1-1/2"	Pin	80
841012B	1"	1-1/2"	Ball	80



C Impact Extension Bars

ITEM NO.	Retention Device	Length mm (Inch)
840150	Pin	150mm (6")
840150B	Ball	150mm (6")
841064	Pin	200mm (8")
841064B	Ball	200mm (8")
840250	Pin	250mm (10")
840250B	Ball	250mm (10")
840400	Pin	400mm (16")
840400B	Ball	400mm (16")



B Impact Universal Joints

ITEM NO.	Retention Device	Outside Diameter mm	Length mm
840808	Pin	52 mm	130
840808B	Ball	52 mm	130



1" Dr. Impact Sockets

6 pt. SAE Impact Sockets



ITEM NO.	Size Inch	Length mm
867026	13/16	60
867028	7/8	60
867030	15/16	60
867032	1	60
867034	1-1/16	60
867036	1-1/8	60
867038	1-3/16	62
867040	1-1/4	63
867042	1-5/16	63
867044	1-3/8	63
867046	1-7/16	67
867048	1-1/2	67
867050	1-9/16	67
867052	1-5/8	70
867054	1-11/16	70
867056	1-3/4	70
867058	1-13/16	70
867060	1-7/8	70
867062	1-15/16	70
867064	2	70
867066	2-1/16	82
867068	2-1/8	82
867070	2-3/16	87
867072	2-1/4	87
867074	2-5/16	87
867076	2-3/8	91
867080	2-1/2	91
867084	2-5/8	95
867088	2-3/4	100
867090	2-13/16	100
867094	2-15/16	105
867096	3	105
867100	3-1/8	105
867108	3-3/8	110
867112	3-1/2	110

6 pt. SAE Deep Impact Sockets



ITEM NO.	Size Inch	Length mm
869524	3/4	90
869526	13/16	90
869528	7/8	90
869530	15/16	90
869532	1	90
869534	1-1/16	90
869534T*	1-1/16	90
869536	1-1/8	90
869536T*	1-1/8	90
869538	1-3/16	90
869540	1-1/4	90
869540T*	1-1/4	90
869542	1-5/16	90
869544	1-3/8	90
869546	1-7/16	90
869548	1-1/2	90
869550	1-9/16	90
869552	1-5/8	90
869554	1-11/16	90
869556	1-3/4	95
869558	1-13/16	100
869560	1-7/8	100
869562	1-15/16	100
869564	2	100
869566	2-1/16	100
869568	2-1/8	100
869570	2-3/16	110
869572	2-1/4	110
869574	2-5/16	110
869576	2-3/8	110
869580	2-1/2	120
869584	2-5/8	120
869588	2-3/4	125
869596	3	150

*Thin Wall Sockets

1" Dr. Impact Socket Sets

CM-808M 8pcs Metric Impact Socket Set

8 1" Dr. Socket (847022 ~ 847038)
22 - 24 - 27 - 30 - 32 - 33 - 35 - 38mm

6000g 4 Sets / 25 Kgs / 0.60 CUFT



IS-817M 17pcs Metric Impact Socket Set

17 1" Dr. Socket (847024 ~ 847075)
24 - 27 - 30 - 32 - 33 - 35 - 36 - 38 - 41 - 46 - 50 - 54 - 55 - 60 - 65 - 70 - 75mm

21570g 1 Sets / 22.5 Kgs / 1.40 CUFT



CD-808MD 8pcs Metric Deep Impact Socket Set

8 1" Dr. Deep Socket (849522 ~ 849538)
22 - 24 - 27 - 30 - 32 - 33 - 35 - 38mm

8600g 2 Sets / 18.5 Kgs / 0.40 CUFT



1" Dr. Impact Socket Sets

TR-811M 11pcs Metric Truck Wheel Deep Impact Socket Set

3 1" Dr. Socket (847027 ~ 847032)
27 - 30 - 32mm

5 1" Dr. Deep Socket (849533 ~ 849541)
33 - 35 - 36 - 38 - 41mm

3 1" Dr. Budd Wheel (846017S ~ 846021S)
17 - 20 - 21mm Square

9340g 2 Sets / 20 Kgs / 0.95 CUFT



CM-808S 8pcs SAE Impact Socket Set

8 1" Dr. Socket (867028 ~ 867048)
7/8 - 15/16 - 1" - 1 1/16 - 1 1/8 - 1 3/16 - 1 1/4 - 1 1/2"

5900g 4 Sets / 24.5 Kgs / 0.60 CUFT



IS-817S 17pcs SAE Impact Socket Set

17 1" Dr. Socket (867046 ~ 867100)
1 7/16 - 1 1/2 - 1 5/8 - 1 11/16 - 1 3/4 - 1 13/16 - 1 7/8 - 2" - 2 1/8 - 2 3/16 - 2 1/4 - 2 3/8 - 2 1/2 - 2 5/8 - 2 3/4 - 2 15/16 - 3 1/8"

27670g 1 Sets / 28.5 Kgs / 1.40 CUFT



CD-808SD 8pcs SAE Deep Impact Socket Set

8 1" Dr. Deep Socket (869528 ~ 869548)
7/8 - 15/16 - 1" - 1 1/16 - 1 1/8 - 1 3/16 - 1 1/4 - 1 1/2"

8360g 2 Sets / 18 Kgs / 0.40 CUFT



TR-811S 11pcs SAE Truck Wheel Deep Impact Socket Set

4 1" Dr. Socket (867028 ~ 867038)
7/8 - 15/16 - 1" - 1 3/16"

1 1" Dr. Deep Socket (869556)
1 3/4"

3 1" Dr. Deep Thin Wall (869534T ~ 869540T)
1 1/16 - 1 1/8 - 1 1/4"

2 1" Dr. Budd Wheel (866026S ~ 866030S)
13/16 - 15/16" Square

1 1" Dr. Deep Budd Wheel (869548B)
1 1/2" Hex

8620g 2 Sets / 18.5 Kgs / 0.95 CUFT



TR-811MS 11pcs Metric & SAE Truck Wheel Deep Impact Socket

4 1" Dr. Deep Socket (849533 ~ 849541)
33 - 35 - 38 - 41mm

2 1" Dr. Budd Wheel (846017S ~ 846021S)
17 - 21mm Square

3 1" Dr. Deep Thin Wall (869534T ~ 869540T)
1 1/16 - 1 1/8 - 1 1/4"

1 1" Dr. Budd Wheel (866026S)
13/16" Square

1 1" Dr. Deep Budd Wheel (869548B)
1 1/2" Hex

9860g 2 Sets / 21 Kgs / 0.95 CUFT



1-1/2" Dr. Jumbo Impact Sockets



Metric Jumbo Impact Sockets

ITEM NO.	Size mm	Length mm
938441	41	80
938442	42	80
938443	43	80
938446	46	84
938450	50	84
938452	52	84
938454	54	84
938455	55	90
938458	58	90
938460	60	90
938463	63	95
938465	65	95
938470	70	100
938475	75	105
938480	80	110
938485	85	110
938490	90	112
938495	95	112
938500	100	115
938505	105	120
938510	110	124
938515	115	128
938520	120	132
938525	125	136
938530	130	140
938535	135	145
938540	140	150
938545	145	155
938550	150	160

SAE Jumbo Impact Sockets

ITEM NO.	Size Inch	Length mm
938724	3-7/8	115
938726	3-15/16	115
938728	4	120
938730	4-1/16	120
938732	4-1/8	120
938734	4-3/16	120
938736	4-1/4	124
938738	4-5/16	124
938740	4-3/8	124
938742	4-7/16	124
938744	4-1/2	128
938746	4-9/16	128
938748	4-5/8	132
938750	4-11/16	132
938752	4-3/4	132
938754	4-13/16	132
938756	4-7/8	136
938758	4-15/16	136
938760	5	140
938762	5-1/16	140
938764	5-1/8	140
938766	5-3/16	140
938768	5-1/4	145
938770	5-5/16	145
938772	5-3/8	145
938774	5-7/16	150
938776	5-1/2	150
938778	5-9/16	150
938780	5-5/8	155
938782	5-11/16	155
938784	5-3/4	155
938786	5-13/16	160
938788	5-7/8	160
938790	5-15/16	160
938792	6	160
938794	6-1/16	165
938796	6-1/8	165
938798	6-3/16	165
938800	6-1/4	170
938802	6-5/16	170
938804	6-3/8	170
938806	6-7/16	170
938808	6-1/2	175

SAE Jumbo Impact Sockets

ITEM NO.	Size Inch	Length mm
938652	1-5/8	80
938654	1-11/16	80
938656	1-3/4	80
938658	1-13/16	84
938660	1-7/8	84
938662	1-15/16	84
938664	2	84
938666	2-1/16	84
938668	2-1/8	84
938670	2-3/16	90
938672	2-1/4	90
938674	2-5/16	90
938676	2-3/8	90
938678	2-7/16	95
938680	2-1/2	95
938682	2-9/16	95
938684	2-5/8	100
938686	2-11/16	100
938688	2-3/4	100
938690	2-13/16	105
938692	2-7/8	105
938694	2-15/16	105
938696	3	105
938698	3-1/16	105
938700	3-1/8	110
938702	3-3/16	110
938704	3-1/4	110
938706	3-5/16	110
938708	3-3/8	110
938710	3-7/16	112
938712	3-1/2	112
938714	3-9/16	112
938716	3-5/8	112
938718	3-11/16	112
938720	3-3/4	112
938722	3-13/16	115

1-1/2" Dr. Accessories

A Impact Adapters

ITEM NO.	Female Drive	Male Drive	Length mm
938008	1-1/2"	1"	98
938020	1-1/2"	2-1/2"	125

B Impact Extension Bars

ITEM NO.	Female Drive	Length mm
938175	1-1/2"	175
938250	1-1/2"	250
938330	1-1/2"	330

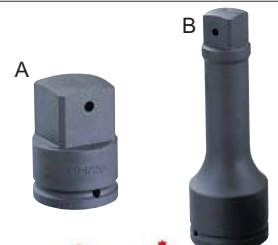

Hand Sockets

1/4" Dr. Hand Sockets

6 pt. Metric Hand Sockets



ITEM NO.	Size mm	Length mm
222503	3	25
222504	4	25
2225045	4.5	25
222505	5	25
2225055	5.5	25
222506	6	25
222507	7	25
222508	8	25
222509	9	25
222510	10	25
222511	11	25
222512	12	25
222513	13	25
222514	14	25

6 pt. Metric Deep Hand Sockets



ITEM NO.	Size mm	Length mm
225204	4	50
2252045	4.5	50
225205	5	50
2252055	5.5	50
225206	6	50
225207	7	50
225208	8	50
225209	9	50
225210	10	50
225211	11	50
225212	12	50
225213	13	50
225214	14	50

12 pt. Metric Hand Sockets



ITEM NO.	Size mm	Length mm
232505	5	25
2325055	5.5	25
232506	6	25
232507	7	25
232508	8	25
232509	9	25
232510	10	25
232511	11	25
232512	12	25
232513	13	25
232514	14	25

12 pt. Metric Deep Hand Sockets



ITEM NO.	Size mm	Length mm
235205	5	50
2352055	5.5	50
235206	6	50
235207	7	50
235208	8	50
235209	9	50
235210	10	50
235211	11	50
235212	12	50
235213	13	50
235214	14	50

6 pt. SAE Hand Sockets



ITEM NO.	Size Inch	Length mm
282504	1/8	25
282506	3/16	25
282507	7/32	25
282508	1/4	25
282509	9/32	25
282510	5/16	25
282511	11/32	25
282512	3/8	25
282514	7/16	25
282516	1/2	25
282518	9/16	25

6 pt. SAE Deep Hand Sockets



ITEM NO.	Size Inch	Length mm
285206	3/16	50
285207	7/32	50
285208	1/4	50
285209	9/32	50
285210	5/16	50
285211	11/32	50
285212	3/8	50
285214	7/16	50
285216	1/2	50
285218	9/16	50

12 pt. SAE Hand Sockets



ITEM NO.	Size Inch	Length mm
272506	3/16	25
272507	7/32	25
272508	1/4	25
272509	9/32	25
272510	5/16	25
272511	11/32	25
272512	3/8	25
272514	7/16	25
272516	1/2	25
272518	9/16	25

12 pt. SAE Deep Hand Sockets



ITEM NO.	Size Inch	Length mm
275206	3/16	50
275207	7/32	50
275208	1/4	50
275209	9/32	50
275210	5/16	50
275211	11/32	50
275212	3/8	50
275214	7/16	50
275216	1/2	50
275218	9/16	50

1/4" Dr. Hand Sockets

12 pt. Metric Universal Hand Sockets



ITEM NO.	Size mm	Length mm
253506	6	33
253507	7	33
253508	8	34
253509	9	34
253510	10	35
253511	11	36
253512	12	37
253513	13	37
253514	14	37

12 pt. SAE Universal Hand Sockets



ITEM NO.	Size Inch	Length mm
263708	1/4	33
263710	5/16	34
263712	3/8	35
263714	7/16	36
263716	1/2	37
263718	9/16	37

Hex Metric Head Sockets



ITEM NO.	Size mm	Length mm
232803	3	26
232804	4	26
232805	5	26
232806	6	26
232807	7	26
232808	8	26
232809	9	26
232810	10	26

Hex SAE Head Sockets



ITEM NO.	Size Inch	Length mm
272804	1/8	26
272805	5/32	26
272806	3/16	26
272807	7/32	26
272808	1/4	26
272809	9/32	26
272810	5/16	26
272812	3/8	26

Slotted Head Sockets



ITEM NO.	Size mm	Length mm
222640	0.8 x 4.0	26
222655	1.0 x 5.5	26
222665	1.2 x 6.5	26
222680	1.2 x 8.0	26
222685	1.6 x 8.5	26
222695	1.6 x 9.7	26

Philips Head Sockets



ITEM NO.	Size	Length mm
222601	#1	26
222602	#2	26
222603	#3	26
222604	#4	26

E-Star Hand Sockets



ITEM NO.	Size	Length mm
252504	E-4	22
252505	E-5	22
252506	E-6	22
252507	E-7	22
252508	E-8	22
252510	E-10	22
252511	E-11	22

1/4" Dr. Accessories



ITEM NO.	Length mm
280272S	165



ITEM NO.	Length mm
280272P	150



ITEM NO.	Length mm
280272	130



ITEM NO.	Length mm
280231S	165

1/4" Dr. Accessories

E 36 Teeth Ratchet w/ Quick Release		F 36 Teeth Ratchet w/ Quick Release	
ITEM NO.	Length mm	ITEM NO.	Length mm
280231P	150	280231R	130
G 72 Teeth Rotor Ratchet		H 72 Teeth Rotor Ratchet	
ITEM NO.	Length mm	ITEM NO.	Length mm
281802P	165	281802	140
I 72 Teeth Flex Head Ratchet		J 72 Teeth Flex Head Ratchet	
ITEM NO.	Length mm	ITEM NO.	Length mm
282262P	190	282262	170
K Hinge Handle		L Hinge Handle	
ITEM NO.	Length mm	ITEM NO.	Length mm
280226P	170	280226	150
M Reversible Ratchet		N Hinge Handle	
ITEM NO.	Length mm	ITEM NO.	Length mm
280222R	140	280226A	150
O 1/4" & 3/8" Double Drive Ratchet		P Sliding T-Handle	
ITEM NO.	Length mm	ITEM NO.	Length mm
380371	130	280020	150
Q Socket Driver		R Socket Driver	
ITEM NO.	Length mm	ITEM NO.	Length mm
506+0175	175	220150	140
S Folding Socket Driver		T Bit Holders	
ITEM NO.	Length mm	ITEM NO.	Hex Shank
220160	175	283508	1/4"
		283510	5/16"
U Adapter		V Universal Joint	
ITEM NO.	Female Drive	Male Drive	Length mm
280030	1/4"	3/8"	25
W Extension Bars		X Wobble Extension Bars	
ITEM NO.	Length mm (Inch)	ITEM NO.	Length mm (Inch)
220002	50mm (2")	220002B	50mm (2")
220003	75mm (3")	220004B	100mm (4")
220004	100mm (4")	220006B	150mm (6")
220006	150mm (6")	220009B	225mm (9")
220009	225mm (9")		
220012	300mm (12")		

1/4" Dr. Hand Socket Sets

TW-211M 11pcs Metric Hand Socket Set	
11	12 pt.
5 - 5.5 - 6 - 7 - 8 - 9 - 10 - 11 - 12 - 13 - 14mm	
240g 40 Sets / 10.5 Kgs / 0.71 CUFT	
US-209M 9pcs Metric Universal Hand Socket Set	
9	12 pt.
6 - 7 - 8 - 9 - 10 - 11 - 12 - 13 - 14mm	
360g 80 Sets / 16.5 Kgs / 1.60 CUFT	
GD-211M 11pcs Metric Deep Hand Socket Set	
11	6 pt.
4 - 5 - 5.5 - 6 - 7 - 8 - 9 - 10 - 11 - 12 - 13mm	
400g 20 Sets / 9 Kgs / 0.71 CUFT	
TW-211MD 11pcs Metric Deep Hand Socket Set	
11	12 pt.
5 - 5.5 - 6 - 7 - 8 - 9 - 10 - 11 - 12 - 13 - 14mm	
370g 20 Sets / 8 Kgs / 0.71 CUFT	
TW-210S 10pcs SAE Hand Socket Set	
10	12 pt.
3/16 - 7/32 - 1/4 - 9/32 - 5/16 - 11/32 - 3/8 - 7/16 - 1/2 - 9/16"	
210g 40 Sets / 9 Kgs / 0.71 CUFT	
US-206S 6pcs SAE Hand Socket Set	
6	12 pt.
1/4 - 5/16 - 3/8 - 7/16 - 1/2 - 9/16"	
250g 120 Sets / 18 Kgs / 1.60 CUFT	
GD-210S 10pcs SAE Deep Hand Socket Set	
10	6 pt.
3/16 - 7/32 - 1/4 - 9/32 - 5/16 - 11/32 - 3/8 - 7/16 - 1/2 - 9/16"	
360g 20 Sets / 8 Kgs / 0.71 CUFT	
TW-210SD 10pcs SAE Deep Hand Socket Set	
10	12 pt.
3/16 - 7/32 - 1/4 - 9/32 - 5/16 - 11/32 - 3/8 - 7/16 - 1/2 - 9/16"	
320g 20 Sets / 7 Kgs / 0.71 CUFT	
EX-2349* 9pcs Extension Bar Set	
3	1/6 Tray
50 - 100 - 150mmL	
3	
45 - 75 - 150mmL	
3	
50 - 125 - 250mmL	
1170g 10 Sets / 13 Kgs / 0.93 CUFT	

*also available with Wobble Extension Bars (BE-2349)

Hand Sockets

1/4" Dr. Hand Socket Sets

deep GS-255MS 55pcs Metric & SAE Deep Hand Socket Set 6 pt.

- 14 1/4" Dr. Socket (222503 ~ 222514)
3 - 4 - 4.5 - 5 - 5.5 - 6 - 7 - 8 - 9 - 10 - 11 - 12 - 13 - 14mm
- 13 1/4" Dr. Deep Socket (225204 ~ 225214)
4 - 4.5 - 5 - 5.5 - 6 - 7 - 8 - 9 - 10 - 11 - 12 - 13 - 14mm
- 11 1/4" Dr. Socket (282504 ~ 282518)
1/8 - 3/16 - 7/32 - 1/4 - 9/32 - 5/16 - 11/32 - 3/8 - 7/16 - 1/2 - 9/16"
- 10 1/4" Dr. Deep Socket (285206 ~ 285218)
3/16 - 7/32 - 1/4 - 9/32 - 5/16 - 11/32 - 3/8 - 7/16 - 1/2 - 9/16"
- 1 Adapter 1/4"F x 3/8"M (280030)
- 1 Universal Joint (280070)
- 1 1/4" Hex Shank Bit Holder (283508)
- 4 Extension 2 - 3 - 4 - 6"L (220002 ~ 220006)

1760g 12 Sets / 22 Kgs / 1.16 CUFT

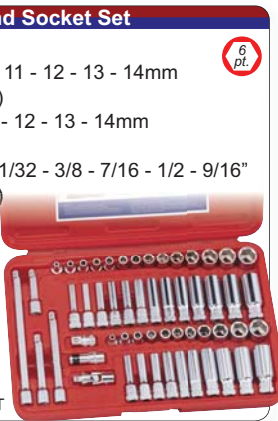

1/4" Dr. Socket Sets w/ Rubber Handle Ratchet

EU-228M 28pcs Metric Hand Socket Set 6 pt.

- 11 1/4" Dr. Socket (222504 ~ 222513)
4 - 5 - 5.5 - 6 - 7 - 8 - 9 - 10 - 11 - 12 - 13mm
- 3 Slotted (1140 ~ 1170) 4 - 6 - 7mm
- 3 Philips (1101 ~ 1103) #1 - 2 - 3
- 4 Hex (2133 ~ 2136) 3 - 4 - 5 - 6mm
- 1 Universal Joint (280070)
- 1 1/4" Hex Shank Bit Holder (283508)
- 2 Ext. 50 - 150mmL (220002 ~ 220006)
- 1 Sliding T-Handle (280020)
- 1 Socket Driver (506+0175)
- 1 Quick Release Ratchet (280231S)

870g 20 Sets / 18.5 Kgs / 1.50 CUFT



deep EU-232M 32pcs Metric Deep Hand Socket Set 6 pt.

- 13 1/4" Dr. Socket (222503 ~ 222514)
3 - 4 - 5 - 5.5 - 6 - 7 - 8 - 9 - 10 - 11 - 12 - 13 - 14mm
- 12 1/4" Dr. Deep Socket (225204 ~ 225214)
4 - 5 - 5.5 - 6 - 7 - 8 - 9 - 10 - 11 - 12 - 13 - 14mm
- 1 Universal Joint (280070)
- 3 Ext. 50 - 100 - 150mmL (220002 ~ -06)
- 1 Sliding T-Handle (280020)
- 1 Socket Driver (506+0175)
- 1 Quick Release Ratchet (280231S)

1320g 12 Sets / 17 Kgs / 1.16 CUFT



EU-228S 28pcs SAE Hand Socket Set 6 pt.

- 11 1/4" Dr. Socket (282504 ~ 282518)
1/8 - 3/16 - 7/32 - 1/4 - 9/32 - 5/16 - 11/32 - 3/8 - 7/16 - 1/2 - 9/16"
- 3 Slotted (1140 ~ 1170) 4 - 6 - 7mm
- 3 Philips (1101 ~ 1103) #1 - 2 - 3
- 4 Hex (3108 ~ 3124) 1/8 - 5/32 - 3/16 - 7/32"
- 1 Universal Joint (280070)
- 1 1/4" Hex Shank Bit Holder (283508)
- 2 Ext. 2 - 6"L (220002 ~ 220006)
- 1 Sliding T-Handle (280020)
- 1 Socket Driver (506+0175)
- 1 Quick Release Ratchet (280231S)

870g 20 Sets / 18.5 Kgs / 1.50 CUFT



EU-230MS 30pcs Metric & SAE Hand Socket Set 6 pt.

- 13 1/4" Dr. Socket (222503 ~ 222514)
3 - 4 - 5 - 5.5 - 6 - 7 - 8 - 9 - 10 - 11 - 12 - 13 - 14mm
- 11 1/4" Dr. Socket (282504 ~ 282518)
1/8 - 3/16 - 7/32 - 1/4 - 9/32 - 5/16 - 11/32 - 3/8 - 7/16 - 1/2 - 9/16"
- 1 Universal Joint (280070)
- 2 Ext. 2 - 6"L (220002 ~ 220006)
- 1 Sliding T-Handle (280020)
- 1 Socket Driver (506+0175)
- 1 Quick Release Ratchet (280231S)

1030g 20 Sets / 22 Kgs / 1.50 CUFT



1/4" Dr. Socket Set w/ Plastic Handle Ratchet

EU-240M 40pcs Metric Hand Socket Set 6 pt.

- 11 1/4" Dr. Socket (222505 ~ 222514)
5 - 5.5 - 6 - 7 - 8 - 9 - 10 - 11 - 12 - 13 - 14mm
- 3 Slotted (1140 ~ 1170) 4 - 6 - 7mm
- 3 Philips (1101 ~ 1103) #1 - 2 - 3
- 3 Posidriv (1211 ~ 1213) #1 - 2 - 3
- 6 Hex (2133 ~ 2138) 3 - 4 - 5 - 6 - 7 - 8mm
- 8 Star (6108 ~ 6140)
T8 - 10 - 15 - 20 - 25 - 27 - 30 - 40
- 1 Universal Joint (280070)
- 1 1/4" Shank Bit Holder (283508)
- 2 Ext. 50 - 150mmL (220002 ~ 220006)
- 1 Socket Driver (506+0175)
- 1 72 Teeth Ratchet (280272P)

1000g 10 Sets / 11 Kgs / 0.82 CUFT



1/4" Dr. Socket Sets w/ Chrome Handle Ratchet

GS-221M 21pcs Metric Deep Hand Socket Set 6 pt.

- 10 1/4" Dr. Socket (222505 ~ 222513)
5 - 5.5 - 6 - 7 - 8 - 9 - 10 - 11 - 12 - 13mm
- 8 1/4" Dr. Deep Socket (225206 ~ 225213)
6 - 7 - 8 - 9 - 10 - 11 - 12 - 13mm
- 1 Ext. 50mmL (220002)
- 1 Socket Driver (220150)
- 1 72 Teeth Ratchet (280272)

830g 20 Sets / 18 Kgs / 1.5 CUFT



deep GS-244MS 44pcs Metric & SAE Deep Hand Socket Set 6 pt.

- 13 1/4" Dr. Socket (222503 ~ 222514)
3 - 4 - 5 - 5.5 - 6 - 7 - 8 - 9 - 10 - 11 - 12 - 13 - 14mm
- 10 1/4" Dr. Deep Socket (2252055 ~ 225214)
5.5 - 6 - 7 - 8 - 9 - 10 - 11 - 12 - 13 - 14mm
- 10 1/4" Dr. Socket (282506 ~ 282518)
3/16 - 7/32 - 1/4 - 9/32 - 5/16 - 11/32 - 3/8 - 7/16 - 1/2 - 9/16"
- 8 1/4" Dr. Deep Socket (285208 ~ 285218)
1/4 - 9/32 - 5/16 - 11/32 - 3/8 - 7/16 - 1/2 - 9/16"
- 2 Extension 2" - 6"L (220002 ~ 220006)
- 1 72 Teeth Ratchet (280272)

1500g 12 Sets / 19 Kgs / 1.16 CUFT

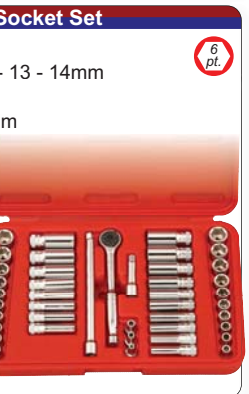

deep TW-242MS 42pcs Metric & SAE Deep Hand Socket Set 12 pt.

- 9 1/4" Dr. Socket (232506 ~ 232514)
6 - 7 - 8 - 9 - 10 - 11 - 12 - 13 - 14mm
- 11 1/4" Dr. Deep Socket (235205 ~ 235214)
5 - 5.5 - 6 - 7 - 8 - 9 - 10 - 11 - 12 - 13 - 14mm
- 10 1/4" Dr. Socket (272506 ~ 272518)
3/16 - 7/32 - 1/4 - 9/32 - 5/16 - 11/32 - 3/8 - 7/16 - 1/2 - 9/16"
- 8 1/4" Dr. Deep Socket (275208 ~ 275218)
1/4 - 9/32 - 5/16 - 11/32 - 3/8 - 7/16 - 1/2 - 9/16"
- 1 Universal Joint (280070)
- 2 Ext. 2" - 6"L (220002 ~ 220006)
- 1 Quick Release Ratchet (280231R)

1470g 12 Sets / 18.6 Kgs / 1.16 CUFT



1/4" Dr. Socket Sets w/ Knurled Handle Ratchet

GS-219M 19pcs Metric Hand Socket Set 3 pt. 6 pt.

- 11 1/4" Dr. Socket (222504 ~ 222512)
4 - 4.5 - 5 - 5.5 - 6 - 7 - 8 - 9 - 10 - 11 - 12mm
- 2 1/4" Dr. 8pt. Socket (242508 ~ 242510)
8 - 10mm
- 1 Universal Joint (280070)
- 2 Ext. 50 - 100mmL (220002 ~ 220004)
- 1 Sliding T-Handle (280020)
- 1 Socket Driver (220150)
- 1 Ratchet (280222R)

1150g 10 Sets / 12.5 Kgs / 0.77 CUFT



1/4" Dr. Socket Sets w/ Knurled Handle Ratchet

GS-229M 29pcs Metric Hand Socket Set 6 pt.

- 13 1/4" Dr. Socket (222504 ~ 222514)
4 - 4.5 - 5 - 5.5 - 6 - 7 - 8 - 9 - 10 - 11 - 12 - 13 - 14mm
- 3 1/4" Dr. Slotted Socket (222640 ~ -80)
4 - 5.5 - 8mm
- 3 1/4" Dr. Phillips Socket (222601 ~ -03)
#1 - 2 - 3
- 5 1/4" Dr. Hex Socket (232803 ~ -08)
3 - 4 - 5 - 6 - 8mm
- 1 Universal Joint (280070)
- 1 Ext. 50mmL (220002)
- 1 Sliding T-Handle (280020)
- 1 Socket Driver (220150)
- 1 Ratchet (280222R)

850g 20 Sets / 18 Kgs / 1.50 CUFT

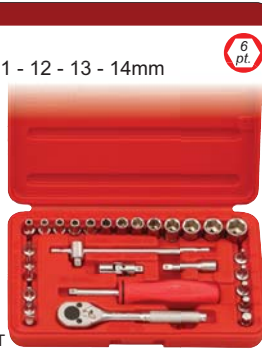

GS-239M 39pcs Metric Hand Socket Set 6 pt.

- 14 1/4" Dr. Socket (222503 ~ 222514)
3 - 4 - 4.5 - 5 - 5.5 - 6 - 7 - 8 - 9 - 10 - 11 - 12 - 13 - 14mm
- 2 1/4" Dr. 8pt. Socket (242508 ~ 242510)
8 - 10mm
- 6 1/4" Dr. Slotted Socket (222640 ~ -95)
4 - 5.5 - 6.5 - 8 - 8.5 - 9.7mm
- 4 1/4" Dr. Phillips Socket (222601 ~ -04)
#1 - 2 - 3 - 4
- 8 1/4" Dr. Hex Socket (232803 ~ -10)
3 - 4 - 5 - 6 - 7 - 8 - 9 - 10mm
- 1 Universal Joint (280070)
- 1 Ext. 100mmL (220004)
- 1 Sliding T-Handle (280020)
- 1 Socket Driver (220150)
- 1 Ratchet (280222R)

1400g 10 Sets / 15 Kgs / 0.77 CUFT



deep GD-220M 20pcs Metric Deep Hand Socket Set 6 pt.

- 13 1/4" Dr. Deep Socket (225204 ~ 225214)
4 - 4.5 - 5 - 5.5 - 6 - 7 - 8 - 9 - 10 - 11 - 12 - 13 - 14mm
- 1 Universal Joint (280070)
- 2 Ext. 50 - 100mmL (220002 ~ 220004)
- 1 Sliding T-Handle (280020)
- 1 Socket Driver (220150)
- 1 Hinge Handle (280226A)
- 1 Ratchet (280222R)

1400g 10 Sets / 15 Kgs / 0.77 CUFT



GS-237S 37pcs SAE Hand Socket Set 6 pt.

- 11 1/4" Dr. Socket (282504 ~ 282518)
1/8 - 3/16 - 7/32 - 1/4 - 9/32 - 5/16 - 11/32 - 3/8 - 7/16 - 1/2 - 9/16"
- 2 1/4" Dr. 8pt. Socket (262508 ~ 262512)
1/4 - 5/16 - 3/8"
- 6 1/4" Dr. Slotted Socket (222640 ~ -95)
4 - 5.5 - 6.5 - 8 - 8.5 - 9.7mm
- 4 1/4" Dr. Phillips Socket (222601 ~ -04)
#1 - 2 - 3 - 4
- 8 1/4" Dr. Hex Socket (272804 ~ -12)
1/8 - 5/32 - 3/16 - 7/32 - 1/4 - 9/32 - 5/16 - 3/8"
- 1 Universal Joint (280070)
- 1 Ext. 4"L (220004)
- 1 Sliding T-Handle (280020)
- 1 Socket Driver (220150)
- 1 Ratchet (280222R)

1350g 10 Sets / 14.5 Kgs / 0.77 CUFT



deep GD-217S 17pcs SAE Deep Hand Socket Set 6 pt.

- 10 1/4" Dr. Deep Socket (285206 ~ 285218)
3/16 - 7/32 - 1/4 - 9/32 - 5/16 - 11/32 - 3/8 - 7/16 - 1/2 - 9/16"
- 1 Universal Joint (280070)
- 2 Ext. 2 - 4"L (220002 ~ 220004)
- 1 Sliding T-Handle (280020)
- 1 Socket Driver (220150)
- 1 Hinge Handle (280226A)
- 1 Ratchet (280222R)

1350g 10 Sets / 15 Kgs / 0.77 CUFT



3/8" Dr. Hand Sockets

6 pt. Metric Hand Sockets

ITEM NO.	Size mm	Length mm
323206	6	28
323207	7	28
323208	8	28
323209	9	28
323210	10	28
323211	11	30
323212	12	30
323213	13	30
323214	14	30
323215	15	30
323216	16	30
323217	17	32
323218	18	32
323219	19	32
323220	20	32
323221	21	32
323222	22	32

6 pt. Metric Deep Hand Sockets

ITEM NO.	Size mm	Length mm
326306	6	63
326307	7	63
326308	8	63
326309	9	63
326310	10	63
326311	11	63
326312	12	63
326313	13	63
326314	14	63
326315	15	63
326316	16	63
326317	17	63
326318	18	63
326319	19	63
326320	20	63
326321	21	63
326322	22	63



12 pt. Metric Hand Sockets

ITEM NO.	Size mm	Length mm
333206	6	28
333207	7	28
333208	8	28
333209	9	28
333210	10	28
333211	11	30
333212	12	30
333213	13	30
333214	14	30
333215	15	30
333216	16	30
333217	17	32
333218	18	32
333219	19	32
333220	20	32
333221	21	32
333222	22	32

12 pt. Metric Deep Hand Sockets

ITEM NO.	Size mm	Length mm
336306	6	63
336307	7	63
336308	8	63
336309	9	63
336310	10	63
336311	11	63
336312	12	63
336313	13	63
336314	14	63
336315	15	63
336316	16	63
336317	17	63
336318	18	63
336319	19	63
336320	20	63
336321	21	63
336322	22	63



6 pt. SAE Hand Sockets

ITEM NO.	Size Inch	Length mm
383208	1/4	28
383210	5/16	28
383211	11/32	28
383212	3/8	28
383214	7/16	30
383216	1/2	30
383218	9/16	30
383219	19/32	30
383220	5/8	30
383222	11/16	32
383224	3/4	32
383225	25/32	32
383226	13/16	32
383228	7/8	32

6 pt. SAE Deep Hand Sockets

ITEM NO.	Size Inch	Length mm
386308	1/4	63
386310	5/16	63
386311	11/32	63
386312	3/8	63
386314	7/16	63
386316	1/2	63
386318	9/16	63
386319	19/32	63
386320	5/8	63
386322	11/16	63
386324	3/4	63
386325	25/32	63
386326	13/16	63
386328	7/8	63



Hand Sockets

3/8" Dr. Hand Sockets

12 pt. SAE Hand Sockets

ITEM NO.	Size Inch	Length mm
373208	1/4	28
373210	5/16	28
373211	11/32	28
373212	3/8	28
373214	7/16	30
373216	1/2	30
373218	9/16	30
373219	19/32	30
373220	5/8	30
373222	11/16	32
373224	3/4	32
373225	25/32	32
373226	13/16	32
373228	7/8	32

12 pt. SAE Deep Hand Sockets

ITEM NO.	Size Inch	Length mm
376308	1/4	63
376310	5/16	63
376311	11/32	63
376312	3/8	63
376314	7/16	63
376316	1/2	63
376318	9/16	63
376319	19/32	63
376320	5/8	63
376322	11/16	63
376324	3/4	63
376325	25/32	63
376326	13/16	63
376328	7/8	63

12 pt. Metric Universal Hand Sockets

ITEM NO.	Size mm	Length mm
355610	10	51
355611	11	51
355612	12	51
355613	13	51
355614	14	52
355615	15	53
355616	16	54
355617	17	54
355618	18	56
355619	19	56

12 pt. SAE Universal Hand Sockets

ITEM NO.	Size Inch	Length mm
365612	3/8	51
365614	7/16	51
365616	1/2	51
365618	9/16	52
365620	5/8	54
365622	11/16	56
365624	3/4	56

6 pt. Spark Plug Sockets

ITEM NO.	Size	Length mm
326016	5/8" (16mm)	63
326021	13/16" (20.6mm)	63

E-Star Hand Sockets

ITEM NO.	Size	Length mm
353510	E-10	28
353511	E-11	28
353512	E-12	28
353514	E-14	28
353516	E-16	28
353518	E-18	30
353520	E-20	30

6 pt. Swivel Spark Plug Sockets

ITEM NO.	Size	Length mm
318516	5/8" (16mm)	90
318521	13/16" (20.6mm)	90

3/8" Dr. Accessories

A 72 Teeth Ratchet

ITEM NO.	Length mm
380372S	225

B 72 Teeth Ratchet

ITEM NO.	Length mm
380372P	220

C 72 Teeth Ratchet

ITEM NO.	Length mm
380372	200

D 36 Teeth Ratchet w/ Quick Release

ITEM NO.	Length mm
380331S	220

3/8" Dr. Accessories

E 36 Teeth Ratchet w/ Quick Release

ITEM NO.	Length mm
380331P	200

F 36 Teeth Ratchet w/ Quick Release

ITEM NO.	Length mm
380331R	180

G 72 Teeth Rotor Ratchet

ITEM NO.	Length mm
381803P	250

H 72 Teeth Rotor Ratchet

ITEM NO.	Length mm
381803	220

I 72 Teeth Flex Head Ratchets

ITEM NO.	Length mm
383363P	250
383338P	300

J 72 Teeth Flex Head Ratchets

ITEM NO.	Length mm
383363	230
383338	280

K 72 Teeth Bent Handle Flex Head

ITEM NO.	Length mm
383383P	290

L 72 Teeth Bent Handle Flex Head

ITEM NO.	Length mm
383383L	270

M Hinge Handle

ITEM NO.	Length mm
380336P	230

N Hinge Handle

ITEM NO.	Length mm
380336	200

O Reversible Ratchet

ITEM NO.	Length mm
380333R	200

P Hinge Handle

ITEM NO.	Length mm
380336A	200

Q Flex Head Ratchet

ITEM NO.	Length mm
380375	250

R Sliding T-Handle

ITEM NO.	Length mm
380030	250

S 1/4" & 3/8" Double Drive Ratchet

ITEM NO.	Length mm
380371	130

T 72 Teeth Stubby Ratchet

ITEM NO.	Length mm
380370	100

U Speed Handle

ITEM NO.	Length mm
380400	400

V T-Handles (Quick Release)

ITEM NO.	Length mm
324203	420
327003	700

W T-Handles (Ball Joint)

ITEM NO.	Length mm
323503T	350
325003T	500

X T-Handles (Universal Joint)

ITEM NO.	Length mm
324203U	420
327003U	700

3/8" Dr. Accessories

Y Bit Holders

ITEM NO.	Hex Shank	Length mm
384608	1/4"	46
383908	1/4"	39
384610	5/16"	46
383910	5/16"	39
383912	3/8"	39
323910	10mm	39

Z Adapters

ITEM NO.	Female Drive	Male Drive	Length mm
320020	3/8"	1/4"	30
320040	3/8"	1/2"	35

a Universal Joint

ITEM NO.	Length mm
380070	54

b Extension Bars

ITEM NO.	Length mm (Inch)
320025	25mm (1")
320045	45mm (1-3/4")
320075	75mm (3")
320150	150mm (6")
320200	200mm (8")
320250	250mm (10")

c Wobble Extension Bars

ITEM NO.	Length mm (Inch)
320002B	45mm (1-3/4")
320003B	75mm (3")
320006B	150mm (6")
320008B	200mm (8")
320012B	300mm (12")
320018B	450mm (18")

3/8" Dr. Hand Socket Sets

GS-312M 12pcs Metric Hand Socket Set 6 pl.

12 3/8" Dr. Socket (323208 ~ 323219)
8 - 9 - 10 - 11 - 12 - 13 - 14 - 15 - 16 - 17 - 18 - 19mm

 650g  40 Sets / 27 Kgs / 1.94 CUFT

TW-316M 16pcs Metric Hand Socket Set 12 pl.

16 3/8" Dr. Socket (333206 ~ 333221)
6 - 7 - 8 - 9 - 10 - 11 - 12 - 13 - 14 - 15 - 16 - 17 - 18 - 19 - 20 - 21mm

 900g  20 Sets / 19 Kgs / 0.73 CUFT

US-310M 10pcs Metric Universal Hand Socket Set 12 pl.

10 3/8" Dr. Universal Socket (355610 ~ 355619)
10 - 11 - 12 - 13 - 14 - 15 - 16 - 17 - 18 - 19mm

 670g  30 Sets / 21 Kgs / 1.21 CUFT

deep GD-312M 12pcs Metric Deep Hand Socket Set 6 pl.

12 3/8" Dr. Deep Socket (326308 ~ 326319)
8 - 9 - 10 - 11 - 12 - 13 - 14 - 15 - 16 - 17 - 18 - 19mm

 1170g  24 Sets / 29 Kgs / 1.94 CUFT

deep TW-316MD 16pcs Metric Deep Hand Socket Set 12 pl.

16 3/8" Dr. Deep Socket (336306 ~ 336321)
6 - 7 - 8 - 9 - 10 - 11 - 12 - 13 - 14 - 15 - 16 - 17 - 18 - 19 - 20 - 21mm



 1590g  12 Sets / 20 Kgs / 0.73 CUFT

deep GS-332M 32pcs Metric Deep Hand Socket Set 6 pl.

16 3/8" Dr. Socket (323207 ~ -22)
7 - 8 - 9 - 10 - 11 - 12 - 13 - 14 - 15 - 16 - 17 - 18 - 19 - 20 - 21 - 22mm

16 3/8" Dr. Deep Socket (326307 ~ -22)
7 - 8 - 9 - 10 - 11 - 12 - 13 - 14 - 15 - 16 - 17 - 18 - 19 - 20 - 21 - 22mm

 



 3450g  5 Sets / 18.5 Kgs / 0.93 CUFT

3/8" Dr. Hand Socket Sets

GS-314S 14pcs SAE Hand Socket Set 6 pl.



14 3/8" Dr. Socket (383208 ~ 383228)
1/4 - 5/16 - 11/32 - 3/8 - 7/16 - 1/2 - 9/16 - 19/32 - 5/8 - 11/16 - 3/4 - 25/32 - 13/16 - 7/8"



 

 800g  20 Sets / 17 Kgs / 0.92 CUFT

TW-314S 14pcs SAE Hand Socket Set 12 pl.

14 3/8" Dr. Socket (373208 ~ 373228)
1/4 - 5/16 - 11/32 - 3/8 - 7/16 - 1/2 - 9/16 - 19/32 - 5/8 - 11/16 - 3/4 - 25/32 - 13/16 - 7/8"

 800g  20 Sets / 17 Kgs / 0.92 CUFT

US-307S 7pcs SAE Universal Hand Socket Set 12 pl.

7 3/8" Dr. Universal Socket (365612 ~ 365624)
3/8 - 7/16 - 1/2 - 9/16 - 5/8 - 11/16 - 3/4"

 480g  20 Sets / 11 Kgs / 0.71 CUFT

deep GS-314SD 14pcs SAE Deep Hand Socket Set 6 pl.

14 3/8" Dr. Deep Socket (386308 ~ 386328)
1/4 - 5/16 - 11/32 - 3/8 - 7/16 - 1/2 - 9/16 - 19/32 - 5/8 - 11/16 - 3/4 - 25/32 - 13/16 - 7/8"

 1170g  24 Sets / 29 Kgs / 1.94 CUFT

deep TW-314SD 14pcs SAE Deep Hand Socket Set 12 pl.

14 3/8" Dr. Deep Socket (376308 ~ 376328)
1/4 - 5/16 - 11/32 - 3/8 - 7/16 - 1/2 - 9/16 - 19/32 - 5/8 - 11/16 - 3/4 - 25/32 - 13/16 - 7/8"

 1420g  12 Sets / 18 Kgs / 0.73 CUFT

GENIUS TOOLS comfort grip design

available in 1/4", 3/8" & 1/2" Dr. Rotor Ratchets
Quick Release Ratchets
Flex Head Ratchets
Hinge Handles

quick release design securely holds sockets while in use

quick flip reversing lever allows change of direction with one thumb

drop forged chrome vanadium steel and chrome plated for corrosion resistance

rubber cushion grip for added comfort and control

5 degree swing arc for work in confined spaces

rotor head design allows 270° angle adjustment



Hand Sockets

3/8" Dr. Socket Sets w/ Rubber Handle Ratchet

deep AC-359C* 59pcs Metric Deep Hand Socket & Bit Set

17 3/8" Dr. Socket (323206 ~ 323222)
6 - 7 - 8 - 9 - 10 - 11 - 12 - 13 - 14 - 15 - 16 - 17 - 18 - 19 - 20 - 21 - 22mm

9 3/8" Dr. Deep Socket (326308 ~ 326319)
8 - 10 - 11 - 12 - 13 - 14 - 15 - 17 - 19mm

3 Slotted (1150 ~ 1170) 5 - 6 - 7mm

3 Phillips (1101 ~ 1103) #1 - 2 - 3

3 Posidriv (1211 ~ 1213) #1 - 2 - 3

6 Hex (2133 ~ 2138) 3 - 4 - 5 - 6 - 7 - 8mm

9 Tamperproof Star (7110 ~ 7140)
T10 - 15 - 20 - 25 - 30 - 40 - 45 - 50 - 55

1 Adapter 3/8"F x 1/2"M (320040)

1 Universal Joint (380070)

1 1/4" Hex Shank Bit Holder (384608)

2 Spark Plug 16mm (5/8") - 20.6mm (13/16")
(326016 ~ 326021)

2 Ext. 75 - 200mmL (320075 ~ 320200)

1 1/4" Hex Shank Screwdriver Handle (280150)

1 Quick Release Ratchet (380331S)

3400g 4 Sets / 14.5 Kgs / 1.07 CUFT

NEW

*also available in 12 point sockets (AC-359B)

deep EU-354M 54pcs Metric Deep Hand Socket & Bit Socket Set

15 3/8" Dr. Socket (323207 ~ 323222)
7 - 8 - 9 - 10 - 11 - 12 - 13 - 14 - 15 - 16 - 17 - 18 - 19 - 21 - 22mm

15 3/8" Dr. 12pt. Deep Socket (336307 ~ 336322)
7 - 8 - 9 - 10 - 11 - 12 - 13 - 14 - 15 - 16 - 17 - 18 - 19 - 21 - 22mm

4 Slotted (1155 ~ 1290) 5.5 - 6.5 - 8 - 9mm

4 Phillips (1101 ~ 1124) #1 - 2 - 3 - 4

7 Hex Bit Socket (308+2133 ~ 340+2150)
3 - 4 - 5 - 6 - 7 - 8 - 10mm

1 Universal Joint (380070)

1 1/4" Hex Shank Bit Holder (383908)

1 5/16" Hex Shank Bit Holder (383910)

2 Ext. 150 - 250mmL (320150 ~ 320250)

1 Sliding T-Handle (380030)

1 Speed Handle (380400)

1 Hinge Handle (380338S)

1 Quick Release Ratchet (380331S)

5160g 4 Sets / 21.5 Kgs / 1.65 CUFT

3/8" Dr. Socket Sets w/ Chrome Handle Ratchet

deep GS-331M 31pcs Metric Hand Socket Set

12 3/8" Dr. Socket (323208 ~ -19)
8 - 9 - 10 - 11 - 12 - 13 - 14 - 15 - 16 - 17 - 18 - 19mm

12 3/8" Dr. Deep Socket (326308 ~ -19)
8 - 9 - 10 - 11 - 12 - 13 - 14 - 15 - 16 - 17 - 18 - 19mm

1 Universal Joint (380070)

4 Ext. 25 - 75 - 150 - 250mmL
(320025 ~ 320250)

1 Hinge Handle (380338P)

1 Quick Release Ratchet (380331R)

3300g 5 Sets / 17.5 Kgs / 1.01 CUFT

deep GS-347MS 47pcs Metric & SAE Hand Socket Set

14 3/8" Dr. Socket (323206 ~ 323219)
6 - 7 - 8 - 9 - 10 - 11 - 12 - 13 - 14 - 15 - 16 - 17 - 18 - 19mm

10 3/8" Dr. Deep Socket (326310 ~ 326319)
10 - 11 - 12 - 13 - 14 - 15 - 16 - 17 - 18 - 19mm

11 3/8" Dr. Socket (383208 ~ 383228)
1/4 - 5/16 - 3/8 - 7/16 - 1/2 - 9/16 - 5/8 - 11/16 - 3/4 - 13/16 - 7/8"

9 3/8" Dr. Deep Socket (386312 ~ 386328)
3/8 - 7/16 - 1/2 - 9/16 - 5/8 - 11/16 - 3/4 - 13/16 - 7/8"

2 Ext. 3 - 6"L (320075 ~ 320150)

1 72 Teeth Ratchet (380372)

3750g 4 Sets / 16 Kgs / 1.07 CUFT

3/8" Dr. Socket Sets w/ Plastic Handle Ratchet

EU-319M 19pcs Metric Hand Socket Set

14 3/8" Dr. Socket (323208 ~ 323222)
8 - 9 - 10 - 11 - 12 - 13 - 14 - 15 - 16 - 17 - 18 - 19 - 21 - 22mm

1 Universal Joint (380070)

3 Ext. 25 - 75 - 250mmL
(320025 ~ -250)

1 72 Teeth Ratchet (380372P)

1830g 10 Sets / 19.5 Kgs / 1.16 CUFT

3/8" Dr. Socket Sets w/ Knurled Handle Ratchet

GS-320M 20pcs Metric Hand Socket Set

13 3/8" Dr. Socket (323206 ~ 323221)
6 - 8 - 9 - 10 - 11 - 12 - 13 - 14 - 15 - 16 - 17 - 19 - 21mm

2 Spark Plug Socket 16 - 20.6mm
(326016 ~ 326021)

2 Ext. 75 - 200mmL (320075 ~ -200)

1 Sliding T-Handle (380030)

1 Hinge Handle (380336A)

1 Ratchet (380333R)

3000g 6 Sets / 19 Kgs / 0.70 CUFT

deep AC-359* 59pcs Metric Deep Hand Socket & Bit Set

17 3/8" Dr. Socket (333206 ~ 333222)
6 - 7 - 8 - 9 - 10 - 11 - 12 - 13 - 14 - 15 - 16 - 17 - 18 - 19 - 20 - 21 - 22mm

9 3/8" Dr. Deep Socket (336308 ~ 336319)
8 - 10 - 11 - 12 - 13 - 14 - 15 - 17 - 19mm

3 Slotted (1150 ~ 1170) 5 - 6 - 7mm

3 Phillips (1101 ~ 1103) #1 - 2 - 3

3 Posidriv (1211 ~ 1213) #1 - 2 - 3

6 Hex (2133 ~ 2138) 3 - 4 - 5 - 6 - 7 - 8mm

9 Tamperproof Star (7110 ~ 7140)
T10 - 15 - 20 - 25 - 30 - 40 - 45 - 50 - 55

1 Adapter 3/8"F x 1/2"M (320040)

1 Universal Joint (380070)

1 1/4" Hex Shank Bit Holder (384608)

2 Spark Plug Socket 16 - 20.6mm
(326016 ~ 326021)

2 Ext. 75 - 200mmL (320075 ~ 320200)

1 1/4" Hex Shank Screwdriver Handle (280150)

1 Ratchet (380333R)

3400g 4 Sets / 14.5 Kgs / 1.07 CUFT

NEW

*also available in 6 point sockets (AC-359A)

GS-320S 20pcs SAE Hand Socket Set

13 3/8" Dr. Socket (383208 ~ 383228)
1/4 - 5/16 - 3/8 - 7/16 - 1/2 - 9/16 - 19/32 - 5/8 - 11/16 - 3/4 - 25/32 - 13/16 - 7/8"

2 Spark Plug Socket 5/8 - 13/16"
(326016 ~ 326021)

2 Ext. 3 - 8"L (320075 ~ 320200)

1 Sliding T-Handle (380030)

1 Hinge Handle (380336A)

1 Ratchet (380333R)

3000g 6 Sets / 19 Kgs / 0.70 CUFT

GS-332MS 32pcs Metric & SAE Hand Socket Set

15 3/8" Dr. Socket (323206 ~ 323221)
6 - 7 - 8 - 9 - 10 - 11 - 12 - 13 - 14 - 15 - 16 - 17 - 18 - 19 - 21mm

11 3/8" Dr. Deep Socket (383208 ~ 383228)
1/4 - 5/16 - 3/8 - 7/16 - 1/2 - 9/16 - 5/8 - 11/16 - 3/4 - 13/16 - 7/8"

1 Universal Joint (380070)

2 Ext. 3 - 6"L (320075 ~ 320150)

1 Sliding T-Handle (380030)

1 Hinge Handle (380336A)

1 Ratchet (380333R)

3450g 6 Sets / 22 Kgs / 0.70 CUFT

1/4 & 3/8" Dr. Socket Sets







GS-2343MS 43pcs Metric & SAE Hand Socket Set 



- 10  1/4" Dr. Socket (222504 ~ 222512)
4 - 4.5 - 5 - 6 - 7 - 8 - 9 - 10 - 11 - 12mm
- 10  1/4" Dr. Socket (282504 ~ 282516)
1/8 - 3/16 - 7/32 - 1/4 - 9/32 - 5/16 - 11/32 - 3/8 - 7/16 - 1/2"
- 9  3/8" Dr. Socket (323209 ~ 323219)
9 - 10 - 11 - 12 - 13 - 14 - 16 - 17 - 19mm
- 7  3/8" Dr. Socket (383212 ~ 383224)
3/8 - 7/16 - 1/2 - 9/16 - 5/8 - 11/16 - 3/4"
- 1  3/8" Dr. Adapter 3/8"F x 1/4"M (320020)
- 1  3/8" Dr. Spark Plug (326021) 13/16"
- 2  3/8" Dr. Ext. 3 - 8"L (320075 ~ 320200)
- 1  3/8" Dr. Sliding T-Handle (380030)
- 1  1/4" Dr. Socket Driver (220150)
- 1  3/8" Dr. Ratchet (380333R)

 3000g  6 Sets / 19 Kgs / 0.70 CUFT











TX-2319 19pcs Star Hand Socket Set 



- 7  1/4" Dr. Star Socket (252504 ~ 252511)
E4 - 5 - 6 - 7 - 8 - 10 - 11
- 7  3/8" Dr. Star Socket (353510 ~ 353520)
E10 - 11 - 12 - 14 - 16 - 18 - 20
- 1  3/8" Dr. Adapter 3/8"F x 1/4"M (320020)
- 2  3/8" Dr. Ext. 3 - 6"L (320075 ~ 320150)
- 1  1/4" Dr. Folding Socket Driver (220160)
- 1  3/8" Dr. Ratchet (380333R)

 1600g  10 Sets / 17 Kgs / 0.77 CUFT



TX-2356 56pcs Complete Star Type Set 

- 5  1/4" Dr. Star Socket (252504 ~ 252508)
E4 - 5 - 6 - 7 - 8
- 7  3/8" Dr. Star Socket (353510 ~ 353520)
E10 - 11 - 12 - 14 - 16 - 18 - 20
- 3  3/8" Dr. Tamperproof Star Bit Socket
(310+7145 ~ 340+7155) T45 - 50 - 55
- 10  Tamperproof Star (7107 ~ 7140)
T7 - 8 - 9 - 10 - 15 - 20 - 25 - 27 - 30 - 40
- 16  Star Key Wrench (580506 ~ 581470)
T6 - 7 - 8 - 9 - 10 - 15 - 20 - 25 - 27 - 30 - 40 - 45 - 50 - 55 - 60 - 70
- 13  Star Screwdriver (592+6606 ~ 595+6850)
T6 - 7 - 8 - 9 - 10 - 15 - 20 - 25 - 27 - 30 - 40 - 45 - 50
- 1  1/4" Dr. Hex Shank Bit Holder (283508)
- 1  1/4" & 3/8" Double Drive Ratchet (380371)

 3650g  4 Sets / 15.5 Kgs / 1.07 CUFT



1/2" Dr. Hand Sockets



Metric Hand Sockets



Metric Deep Hand Sockets

ITEM NO.	Size mm	Length mm	ITEM NO.	Size mm	Length mm
423808	8	38	427808	8	78
423809	9	38	427809	9	78
423810	10	38	427810	10	78
423811	11	38	427811	11	78
423812	12	38	427812	12	78
423813	13	38	427813	13	78
423814	14	38	427814	14	78
423815	15	38	427815	15	78
423816	16	38	427816	16	78
423817	17	38	427817	17	78
423818	18	38	427818	18	78
423819	19	40	427819	19	78
423820	20	40	427820	20	78
423821	21	40	427821	21	78
423822	22	42	427822	22	78
423823	23	42	427823	23	78
423824	24	44	427824	24	78
423825	25	44	427825	25	78
423826	26	44	427826	26	78
423827	27	46	427827	27	78
423828	28	46	427828	28	78
423829	29	46	427829	29	78
423830	30	46	427830	30	78
423831	31	46	427831	31	78
423832	32	46	427832	32	78
423833	33	46	427833	33	78
423834	34	46	427834	34	78
423835	35	48	427835	35	78
423836	36	48	427836	36	78
423838	38	48	427838	38	78
423839	39	50			
423840	40	55			
423841	41	55			



SAE Hand Sockets



SAE Deep Hand Sockets

ITEM NO.	Size Inch	Length mm	ITEM NO.	Size Inch	Length mm
483810	5/16	38	487810	5/16	78
483812	3/8	38	487812	3/8	78
483814	7/16	38	487814	7/16	78
483816	1/2	38	487816	1/2	78
483818	9/16	38	487818	9/16	78
483819	19/32	38	487819	19/32	78
483820	5/8	38	487820	5/8	78
483822	11/16	38	487822	11/16	78
483824	3/4	40	487824	3/4	78
483825	25/32	40	487825	25/32	78
483826	13/16	40	487826	13/16	78
483828	7/8	42	487828	7/8	78
483830	15/16	44	487830	15/16	78
483832	1	44	487832	1	78
483834	1-1/16	46	487834	1-1/16	78
483836	1-1/8	46	487836	1-1/8	78
483838	1-3/16	46	487838	1-3/16	78
483840	1-1/4	46	487840	1-1/4	78
483842	1-5/16	46	487842	1-5/16	78
483844	1-3/8	48	487844	1-3/8	78
483846	1-7/16	48	487846	1-7/16	78
483848	1-1/2	48	487848	1-1/2	78

Hand Sockets

1/2" Dr. Hand Sockets

12 pt. Metric Hand Sockets



ITEM NO.	Size mm	Length mm
433808	8	38
433809	9	38
433810	10	38
433811	11	38
433812	12	38
433813	13	38
433814	14	38
433815	15	38
433816	16	38
433817	17	38
433818	18	38
433819	19	40
433820	20	40
433821	21	40
433822	22	42
433823	23	42
433824	24	44
433825	25	44
433826	26	44
433827	27	46
433828	28	46
433829	29	46
433830	30	46
433831	31	46
433832	32	46

12 pt. Metric Deep Hand Sockets



ITEM NO.	Size mm	Length mm
437808	8	78
437809	9	78
437810	10	78
437811	11	78
437812	12	78
437813	13	78
437814	14	78
437815	15	78
437816	16	78
437817	17	78
437818	18	78
437819	19	78
437820	20	78
437821	21	78
437822	22	78
437823	23	78
437824	24	78
437825	25	78
437826	26	78
437827	27	78
437828	28	78
437829	29	78
437830	30	78
437831	31	78
437832	32	78

12 pt. SAE Hand Sockets



ITEM NO.	Size Inch	Length mm
473810	5/16	38
473812	3/8	38
473814	7/16	38
473816	1/2	38
473818	9/16	38
473819	19/32	38
473820	5/8	38
473822	11/16	38
473824	3/4	40
473825	25/32	40
473826	13/16	40
473828	7/8	42
473830	15/16	44
473832	1	44
473834	1-1/16	46
473836	1-1/8	46
473838	1-3/16	46
473840	1-1/4	46

12 pt. SAE Deep Hand Sockets



ITEM NO.	Size Inch	Length mm
477810	5/16	78
477812	3/8	78
477814	7/16	78
477816	1/2	78
477818	9/16	78
477819	19/32	78
477820	5/8	78
477822	11/16	78
477824	3/4	78
477825	25/32	78
477826	13/16	78
477828	7/8	78
477830	15/16	78
477832	1	78
477834	1-1/16	78
477836	1-1/8	78
477838	1-3/16	78
477840	1-1/4	78

E-Star Hand Sockets



ITEM NO.	Size	Length mm
454510	E-10	38
454511	E-11	38
454512	E-12	38
454514	E-14	38
454516	E-16	38
454518	E-18	40
454520	E-20	40
454522	E-22	40
454524	E-24	40

6 pt. Spark Plug Sockets



ITEM NO.	Size	Length mm
427016	5/8" (16mm)	70
427021	13/16" (20.6mm)	70

6 pt. Swivel Spark Plug Sockets



ITEM NO.	Size	Length mm
418516	5/8" (16mm)	95
418521	13/16" (20.6mm)	95

1/2" Dr. Accessories

A 72 Teeth Ratchet

ITEM NO.	Length mm
480472S	285

B 72 Teeth Ratchet

ITEM NO.	Length mm
480472P	275

C 72 Teeth Ratchet

ITEM NO.	Length mm
480472	245

D 36 Teeth Ratchet w/ Quick Release

ITEM NO.	Length mm
480431S	285

E 36 Teeth Ratchet w/ Quick Release

ITEM NO.	Length mm
480431P	280

F 36 Teeth Ratchet w/ Quick Release

ITEM NO.	Length mm
480431R	254

G 72 Teeth Rotor Ratchet

ITEM NO.	Length mm
481804P	320

H 72 Teeth Rotor Ratchet

ITEM NO.	Length mm
481804	280

I 72 Teeth Flex Head Ratchets

ITEM NO.	Length mm
484464P	430
484468P	650

J 72 Teeth Flex Head Ratchet

ITEM NO.	Length mm
484464	400

K Hinge Handles

ITEM NO.	Length mm
480446P	410
480448P	620

L Hinge Handle

ITEM NO.	Length mm
480446	380

M Reversible Ratchet

ITEM NO.	Length mm
480444R	250

N Hinge Handle

ITEM NO.	Length mm
480446A	380

O "Spud" Ratchet

ITEM NO.	Length mm
480415	380

P Sliding T-Handle

ITEM NO.	Length mm
480040	320

Q L-Handle

ITEM NO.	Length mm
420260L	260

R Speed Handles

ITEM NO.	Length mm
480420	420
480490	490

S T-Handles (Spark Plug Socket)

ITEM NO.	Size	Length mm
4238016T	5/8" (16mm)	380
4238021T	13/16" (20.6mm)	380
4253016T	5/8" (16mm)	530
4253021T	13/16" (20.6mm)	530

T T-Handles (Quick Release)

ITEM NO.	Length mm
425004	500
427004	700

U T-Handles (Ball Joint)

ITEM NO.	Length mm
423504T	350
425004T	500

V T-Handles (Universal Joint)

ITEM NO.	Length mm
425004U	500
427004U	700

1/2" Dr. Accessories

W Bit Holders

ITEM NO.	Hex Shank	Length mm
484808	1/4"	48
484108	1/4"	41
484810	5/16"	48
484110	5/16"	41

X Adapters

ITEM NO.	Female Drive	Male Drive	Length mm
420033	1/2"	3/8"	38
420066	1/2"	3/4"	41

Y Universal Joint

ITEM NO.	Length mm
480070	78

a Extension Bars

ITEM NO.	Length mm (Inch)
424050	50mm (2")
424075	75mm (3")
424125	125mm (5")
424320	250mm (10")

Z Wobble Extension Bars

ITEM NO.	Length mm (Inch)
420002B	50mm (2")
420003B	75mm (3")
420005B	125mm (5")
420008B	200mm (8")
420010B	250mm (10")
420015B	375mm (15")
420024B	600mm (24")

1/2" Dr. Hand Socket Sets

GS-412M 12pcs Metric Hand Socket Set

12 1/2" Dr. Socket (423808 ~ 423819)
8 - 9 - 10 - 11 - 12 - 13 - 14 - 15 - 16 - 17 - 18 - 19mm



950g 20 Sets / 20 Kgs / 0.70 CUFT

TW-415M 15pcs Metric Hand Socket Set

15 1/2" Dr. Socket (433810 ~ 433830)
10 - 11 - 12 - 13 - 14 - 15 - 16 - 17 - 18 - 19 - 21 - 22 - 24 - 27 - 30mm



2100g 10 Sets / 22 Kgs / 0.45 CUFT

SS-425M 25pcs Metric Hand Socket Set

25 1/2" Dr. Socket (423808 ~ 423836)
8 - 9 - 10 - 11 - 12 - 13 - 14 - 15 - 16 - 17 - 18 - 19 - 20 - 21 - 22 - 23 - 24 - 25 - 26 - 27 - 28 - 29 - 30 - 32 - 36mm



3500g 3 Sets / 12 Kgs / 0.82 CUFT

deep GD-412M 12pcs Metric Deep Hand Socket Set

12 1/2" Dr. Deep Socket (427808 ~ 427819)
8 - 9 - 10 - 11 - 12 - 13 - 14 - 15 - 16 - 17 - 18 - 19mm



1920g 12 Sets / 24 Kgs / 0.70 CUFT

deep DS-425M 25pcs Metric Deep Hand Socket Set

25 1/2" Dr. Deep Socket (427808 ~ -36)
8 - 9 - 10 - 11 - 12 - 13 - 14 - 15 - 16 - 17 - 18 - 19 - 20 - 21 - 22 - 23 - 24 - 26 - 27 - 30mm - 29 - 30 - 32 - 36mm



7000g 3 Sets / 22 Kgs / 0.82 CUFT

deep DS-440M 40pcs Metric Deep Hand Socket Set

19 1/2" Dr. Socket (423809 ~ 423830)
9 - 10 - 11 - 12 - 13 - 14 - 15 - 16 - 17 - 18 - 19 - 20 - 21 - 22 - 23 - 24 - 26 - 27 - 30mm

19 1/2" Dr. Deep Socket (427809 ~ 427830)
9 - 10 - 11 - 12 - 13 - 14 - 15 - 16 - 17 - 18 - 19 - 20 - 21 - 22 - 23 - 24 - 26 - 27 - 30mm

1 Universal Joint (480070)
1 Ext. 125mmL (424125)



7000g 3 Sets / 22 Kgs / 1.16 CUFT

1/2" Dr. Hand Socket Sets

GS-412S 12pcs SAE Hand Socket Set

12 1/2" Dr. Socket (483810 ~ 483832)
5/16 - 3/8 - 7/16 - 1/2 - 9/16 - 5/8 - 11/16 - 3/4 - 13/16 - 7/8 - 15/16 - 1"



1200g 20 Sets / 25 Kgs / 0.69 CUFT

TW-414S 14pcs SAE Hand Socket Set

14 1/2" Dr. Socket (473812 ~ 473840)
3/8 - 7/16 - 1/2 - 9/16 - 5/8 - 11/16 - 3/4 - 13/16 - 7/8 - 15/16 - 1" - 1 1/16 - 1 1/8 - 1 1/4"



2100g 10 Sets / 22 Kgs / 0.45 CUFT

SS-422S 22pcs SAE Hand Socket Set

22 1/2" Dr. Socket (483810 ~ 483848)
5/16 - 3/8 - 7/16 - 1/2 - 9/16 - 19/32 - 5/8 - 11/16 - 3/4 - 25/32 - 13/16 - 7/8 - 15/16 - 1" - 1 1/16 - 1 1/8 - 1 3/16 - 1 1/4 - 1 5/16 - 1 3/8 - 1 7/16 - 1 1/2"



4000g 3 Sets / 13 Kgs / 0.82 CUFT

deep GD-412S 12pcs SAE Deep Hand Socket Set

12 1/2" Dr. Deep Socket (487810 ~ 487832)
5/16 - 3/8 - 7/16 - 1/2 - 9/16 - 5/8 - 11/16 - 3/4 - 13/16 - 7/8 - 15/16 - 1"



2230g 12 Sets / 28 Kgs / 0.69 CUFT

deep DS-422S 22pcs SAE Deep Hand Socket Set

22 1/2" Dr. Deep Socket (487810 ~ 487848)
5/16 - 3/8 - 7/16 - 1/2 - 9/16 - 19/32 - 5/8 - 11/16 - 3/4 - 25/32 - 13/16 - 7/8 - 15/16 - 1" - 1 1/16 - 1 1/8 - 1 3/16 - 1 1/4 - 1 5/16 - 1 3/8 - 1 7/16 - 1 1/2"



6700g 3 Sets / 21 Kgs / 0.82 CUFT

deep DS-434S 34pcs SAE Deep Hand Socket Set

16 1/2" Dr. Socket (483810 ~ 483840)
5/16 - 3/8 - 7/16 - 1/2 - 9/16 - 5/8 - 11/16 - 3/4 - 13/16 - 7/8 - 15/16 - 1" - 1 1/16 - 1 1/8 - 1 3/16 - 1 1/4"

16 1/2" Dr. Deep Socket (487810 ~ 487840)
5/16 - 3/8 - 7/16 - 1/2 - 9/16 - 5/8 - 11/16 - 3/4 - 13/16 - 7/8 - 15/16 - 1" - 1 1/16 - 1 1/8 - 1 3/16 - 1 1/4"

1 Universal Joint (480070)
1 Ext. 5"L (424125)



7000g 3 Sets / 22 Kgs / 1.16 CUFT

TX-409 9pcs Star Hand Socket Set

9 1/2" Dr. Star Socket (454510 ~ 454524)
E10 - 11 - 12 - 14 - 16 - 18 - 20 - 22 - 24



800g 20 Sets / 17 Kgs / 0.64 CUFT

TX-23414 14pcs Star Hand Socket Set

5 1/4" Dr. Star Socket (252504 ~ -08)
E4 - 5 - 6 - 7 - 8

5 3/8" Dr. Star Socket (353510 ~ -16)
E10 - 11 - 12 - 14 - 16

4 1/2" Dr. Star Socket (454518 ~ -24)
E18 - 20 - 22 - 24



720g 20 Sets / 16 Kgs / 0.73 CUFT

Hand Sockets

1/2" Dr. Socket Sets w/ Rubber Handle Ratchet

EU-426M 26pcs Metric Hand Socket Set

21 1/2" Dr. Socket (423810 ~ 423834)
 10 - 11 - 12 - 13 - 14 - 15 - 16 - 17 -
 18 - 19 - 20 - 21 - 22 - 23 - 24 - 26 -
 27 - 28 - 30 - 32 - 34mm

1 Universal Joint (480070)
 2 Ext. 125 - 250mmL (424125 ~ -320)
 1 Sliding T-Handle (480040)
 1 Quick Release Ratchet (480431S)

5200g 4 Sets / 22 Kgs / 1.07 CUFT



EU-421S 21pcs SAE Hand Socket Set

16 1/2" Dr. Socket (473812 ~ 473840)
 3/8 - 7/16 - 1/2 - 9/16 - 19/32 - 5/8 -
 11/16 - 3/4 - 13/16 - 7/8 - 15/16 - 1" -
 1 1/16 - 1 1/8 - 1 3/16 - 1 1/4"

1 Universal Joint (480070)
 2 Ext. 5 - 10"L (424125 ~ -320)
 1 Sliding T-Handle (480040)
 1 Quick Release Ratchet (480431S)

4450g 4 Sets / 19 Kgs / 1.07 CUFT



1/2" Dr. Socket Sets w/ Plastic Handle Ratchet

EU-422M 22pcs Metric Hand Socket Set

18 1/2" Dr. Socket (423808 ~ 423832)
 8 - 10 - 11 - 12 - 13 - 14 - 15 - 16 -
 17 - 18 - 19 - 21 - 22 - 23 - 24 - 27 -
 30 - 32mm

1 Universal Joint (480070)
 2 Ext. 125 - 250mmL (424125 ~ -320)
 1 72 Teeth Ratchet (480472P)

3650g 4 Sets / 15.5 Kgs / 0.85 CUFT



1/2" Dr. Socket Sets w/ Chrome Handle Ratchet

deep TW-439M 39pcs Metric Deep Hand Socket Set

20 1/2" Dr. Socket (433809 ~ 433832)
 9 - 10 - 11 - 12 - 13 - 14 - 15 - 16 -
 17 - 18 - 19 - 20 - 21 - 22 - 23 - 24 -
 26 - 27 - 30 - 32mm

14 1/2" Dr. Deep Socket (437809 ~ 437822)
 9 - 10 - 11 - 12 - 13 - 14 - 15 - 16 -
 17 - 18 - 19 - 20 - 21 - 22mm

1 Two Way Adapter 3/8"F x 1/2"M (320042)
 1 Universal Joint (480070)
 2 Ext. 125 - 250mmL (424125 ~ 424320)
 1 Quick Release Ratchet (480431R)

7500g 2 Sets / 16 Kgs / 1.20 CUFT



deep TW-432S 32pcs SAE Deep Hand Socket Set

16 1/2" Dr. Socket (473812 ~ 473840)
 3/8 - 7/16 - 1/2 - 9/16 - 19/32 - 5/8 -
 11/16 - 3/4 - 25/32 - 13/16 - 7/8 -
 15/16 - 1" - 1 1/16 - 1 1/8 - 1 1/4"

11 1/2" Dr. Deep Socket (477812 ~ 477828)
 3/8 - 7/16 - 1/2 - 9/16 - 19/32 - 5/8 -
 11/16 - 3/4 - 25/32 - 13/16 - 7/8"

1 Two Way Adapter 3/8"F x 1/2"M (320042)
 1 Universal Joint (480070)
 2 Ext. 5 - 10"L (424125 ~ 424320)
 1 Quick Release Ratchet (480431R)

7000g 2 Sets / 15 Kgs / 1.20 CUFT



1/2" Dr. Socket Sets w/ Knurled Handle Ratchet

GS-416M* 16pcs Metric Hand Socket Set

13 1/2" Dr. Socket (423808 ~ 423827)
 8 - 10 - 11 - 12 - 13 - 14 - 16 - 17 -
 19 - 21 - 22 - 24 - 27mm

1 Ext. 125mmL (424125)
 1 Hinge Handle (480446A)
 1 Ratchet (480444R)

3750g 4 Sets / 16 Kgs / 0.93 CUFT



*also available in 12 point sockets (TW-416M)

GS-424M* 24pcs Metric Hand Socket Set

18 1/2" Dr. Socket (423808 ~ 423832)
 8 - 9 - 10 - 11 - 12 - 13 - 14 - 15 - 16 - 17 - 18 - 19 - 21 - 22 -
 24 - 27 - 30 - 32mm

1 Universal Joint (480070)
 1 Spark Plug Socket 20.6mm (427021)
 2 Ext. 125 - 250mmL (424125 ~ 424320)
 1 Sliding T-Handle (480040)
 1 Ratchet (480444R)

5000g 4 Sets / 21 Kgs / 1.07 CUFT



*also available in 12 point sockets (TW-424M)

GS-427M 27pcs Metric Hand Socket Set

19 1/2" Dr. Socket (423810 ~ 423832)
 10 - 11 - 12 - 13 - 14 - 15 - 16 - 17 - 18 - 19 - 21 - 22 - 23 - 24 -
 26 - 27 - 28 - 30 - 32mm

1 Universal Joint (480070)
 1 Spark Plug Socket 20.6mm (427021)
 2 Ext. 125 - 250mm (424125 ~ 424320)
 1 Pin Handle 250mmL (480446PP)
 1 Sliding T-Handle (480040)
 1 Hinge Handle (480446A)
 1 Ratchet (480444R)

6750g 4 Sets / 28 Kgs / 0.88 CUFT



GS-416S* 16pcs SAE Hand Socket Set

13 1/2" Dr. Socket (483810 ~ 483834)
 5/16 - 3/8 - 7/16 - 1/2 - 9/16 - 5/8 -
 11/16 - 3/4 - 13/16 - 7/8 - 15/16 -
 1" - 1 1/16"

1 Ext. 5"L (424125)
 1 Hinge Handle (480446A)
 1 Ratchet (480444R)

3750g 4 Sets / 16 Kgs / 0.93 CUFT



*also available in 12 point sockets (TW-416S)

GS-424S* 24pcs SAE Hand Socket Set

18 1/2" Dr. Socket (483810 ~ 483840)
 5/16 - 3/8 - 7/16 - 1/2 - 9/16 - 19/32 - 5/8 - 11/16 - 3/4 - 25/32 -
 13/16 - 7/8 - 15/16 - 1" - 1 1/16 -
 1 1/8 - 1 3/16 - 1 1/4"

1 Universal Joint (480070)
 1 Spark Plug Socket 13/16" (427021)
 2 Ext. 5 - 10"L (424125 ~ 424320)
 1 Sliding T-Handle (480040)
 1 Ratchet (480444R)

5000g 4 Sets / 21 Kgs / 1.07 CUFT



*also available in 12 point sockets (TW-424S)

GS-427S 27pcs SAE Hand Socket Set

19 1/2" Dr. Socket (483810 ~ 483840)
 5/16 - 3/8 - 7/16 - 1/2 - 9/16 - 19/32 - 5/8 - 21/32 - 11/16 - 3/4 -
 1 1/16 - 1 1/8 - 1 3/16 - 1 1/4"

1 Universal Joint (480070)
 1 Spark Plug Socket 13/16" (427021)
 2 Ext. 5 - 10"L (424125 ~ 424320)
 1 Pin Handle 10"L (480446PP)
 1 Sliding T-Handle (480040)
 1 Hinge Handle (480446A)
 1 Ratchet (480444R)

6750g 4 Sets / 28 Kgs / 0.88 CUFT



GS-446MS* 46pcs Metric & SAE Hand Socket Set

- 23 1/2" Dr. Socket (423808 ~ 423832) 6 pt.
8 - 9 - 10 - 11 - 12 - 13 - 14 - 15 - 16 - 17 - 18 - 19 - 20 - 21 - 22 - 23 - 24 - 25 - 26 - 27 - 28 - 30 - 32mm
- 14 1/2" Dr. Socket (483812 ~ 483840)
3/8 - 7/16 - 1/2 - 9/16 - 5/8 - 11/16 - 3/4 - 13/16 - 7/8 - 15/16 - 1" - 1 1/8 - 1 3/16 - 1 1/4"
- 1 Universal Joint (480070)
- 2 Spark Plug Socket 5/8 - 13/16" (427016 ~ 427021)
- 2 Ext. 5 - 10"L (424125 ~ 424320)
- 1 Pin Handle 10"L (480446PP)
- 1 Sliding T-Handle (480040)
- 1 Hinge Handle (480446A)
- 1 Ratchet (480444R)

9800g 2 Sets / 21 Kgs / 0.73 CUFT



**also available in 12 point sockets (TW-446MS)*

1/4, 3/8 & 1/2" Dr. Socket Sets

AC-2487A 1/4" & 1/2" Dr. 87pcs Metric Master Hand Socket & Bit Set

- 14 1/4" Dr. Socket (222503 ~ 222514) 6 pt.
3 - 4 - 4.5 - 5 - 5.5 - 6 - 7 - 8 - 9 - 10 - 11 - 12 - 13 - 14mm
- 8 1/4" Dr. Deep Socket (225206 ~ 225213)
6 - 7 - 8 - 9 - 10 - 11 - 12 - 13mm
- 15 1/2" Dr. Socket (423810 ~ 423832)
10 - 12 - 13 - 14 - 15 - 16 - 17 - 18 - 19 - 21 - 22 - 24 - 27 - 30 - 32mm
- 4 1/2" Dr. Deep Socket (427810 ~ 427819)
10 - 13 - 17 - 19mm
- 6 Slotted 4.0 - 5.5 - 6.5 - 8.0 - 10 - 12mm
- 4 Phillips #1 - 2 - 3 - 4
- 4 Posidriv #1 - 2 - 3 - 4
- 8 Hex 3 - 4 - 5 - 6 - 8 - 10 - 12 - 14mm
- 10 Star T8 - 10 - 15 - 20 - 25 - 30 - 40 - 45 - 50 - 55
- 2 Universal Joint 1/4"Dr.(280070) & 1/2"Dr.(480070)
- 2 Bit Holder 1/4"Dr. 1/4" Shank(282408) & 1/2"Dr. 5/16" Shank(484810)
- 2 Spark Plug 1/2"Dr. (427016 ~ 427021) 16mm(5/8") - 20.6mm(13/16")
- 4 Ext. 1/4"Dr. 50 - 100mmL & 1/2"Dr. 125 - 250mmL
- 1 Sliding T-Handle 1/4"Dr.(280020)
- 1 Socket Driver 1/4"Dr. (506+0175)
- 2 Quick Release Ratchet 1/4"Dr.(280231S) & 1/2"Dr.(480431S)

6000g 4 Sets / 25 Kgs / 1.65 CUFT



NEW

AC-2487 1/4" & 1/2" Dr. 87pcs Metric Master Hand Socket & Bit Set

- 14 1/4" Dr. Socket (222503 ~ 222514) 6 pt. 12 pt.
3 - 4 - 4.5 - 5 - 5.5 - 6 - 7 - 8 - 9 - 10 - 11 - 12 - 13 - 14mm
- 8 1/4" Dr. Deep Socket (225206 ~ 225213)
6 - 7 - 8 - 9 - 10 - 11 - 12 - 13mm
- 15 1/2" Dr. Socket (433810 ~ 433832)
10 - 13 - 15 - 16 - 17 - 18 - 19 - 20 - 21 - 22 - 23 - 24 - 27 - 30 - 32mm
- 4 1/2" Dr. Deep Socket (437814 ~ 437819)
14 - 16 - 17 - 19mm
- 6 Slotted 4.0 - 5.5 - 6.5 - 8.0 - 10 - 12mm
- 4 Phillips #1 - 2 - 3 - 4
- 4 Posidriv #1 - 2 - 3 - 4
- 8 Hex 3 - 4 - 5 - 6 - 8 - 10 - 12 - 14mm
- 6 Tamperproof Star T8 - 10 - 15 - 20 - 25 - 30
- 4 Star T40 - 45 - 50 - 55
- 2 Universal Joint 1/4"Dr.(280070) & 1/2"Dr.(480070)
- 2 Bit Holder 1/4"Dr. 1/4" Shank(282408) & 1/2"Dr. 5/16" Shank(484810)
- 2 Spark Plug 1/2"Dr. (427016 ~ 427021) 16mm(5/8") - 20.6mm(13/16")
- 4 Ext. 1/4"Dr. 50 - 100mmL & 1/2"Dr. 125 - 250mmL
- 1 Sliding T-Handle 1/4"Dr.(280020)
- 1 Socket Driver 1/4"Dr. (220150)
- 2 Ratchet 1/4"Dr.(280222R) & 1/2"Dr.(480444R)

6120g 4 Sets / 25.5 Kgs / 1.65 CUFT



AC-234125 1/4", 3/8" & 1/2" Dr. 125pcs Metric Tool Set

- 12 1/4" Dr. Socket : 4 - 4.5 - 5 - 5.5 - 6 - 7 - 8 - 9 - 10 - 11 - 12 - 13mm 6 pt.
- 14 3/8" Dr. Socket : 6 - 7 - 8 - 9 - 10 - 11 - 12 - 13 - 14 - 15 - 16 - 17 - 18 - 19mm
- 17 1/2" Dr. Socket : 11 - 12 - 13 - 14 - 15 - 16 - 17 - 18 - 19 - 20 - 21 - 22 - 23 - 24 - 25 - 26 - 27mm
- 8 Slotted 3 - 4 - 5 - 6mm
- 7 Phillips #0 - 1 - 2 - 3
- 4 Posidriv #0 - 1 - 2 - 3
- 6 Hex 3 - 4 - 5 - 6 - 7 - 8mm
- 7 Star T10 - 15 - 20 - 25 - 27 - 30 - 40
- 11 Square #1 - 2 - 3
- 1 3/8"Dr. Adapter x 1/4"M
- 2 Spark Plug 16mm - 20.6mm
- 5 Extensions :
50 - 75 - 125 - 150 - 250mmL
- 1 1/4" Hex Shank Handle
- 1 1/4"Dr. Folding Socket Driver
- 2 Ratchet 3/8"Dr.(380372) & 1/2"Dr.(480472)
- 9 Hex Key Wrench : 1.5 - 2 - 2.5 - 3 - 4 - 5 - 6 - 8 - 10mm
- 11 Combination : 6 - 7 - 8 - 9 - 10 - 12 - 13 - 15 - 16 - 17 - 19mm
- 3 Hex Bit Holder - Insert Bit Holder - 1/4" Hex Shank 1/4"Dr. Adapter
- 3 6" Linesman - 6" Longnose - 6" Diagonal Cutting

7800g 3 Sets / 25.5 Kgs / 2.06 CUFT



AC-23117 1/4" & 3/8" Dr. 117pcs Metric & SAE Tool Set

- 21 1/4" Dr. Socket : 4 - 4.5 - 5 - 5.5 - 6 - 7 - 8 - 9 - 10 - 11 - 12 - 13mm 6 pt.
3/16 - 7/32 - 1/4 - 9/32 - 5/16 - 11/32 - 3/8 - 7/16 - 1/2"
- 17 3/8" Dr. Socket : 9 - 10 - 12 - 13 - 14 - 15 - 17 - 18mm
5/16 - 11/32 - 3/8 - 7/16 - 1/2 - 9/16 - 5/8 - 11/16 - 3/4"
- 7 Star T10 - 15 - 20 - 25 - 27 - 30 - 40
- 8 Slotted 3 - 4 - 5 - 6mm
- 7 Phillips #0 - 1 - 2 - 3
- 4 Posidriv #0 - 1 - 2 - 3
- 6 Hex 3 - 4 - 5 - 6 - 7 - 8mm
- 11 Square #1 - 2 - 3
- 1 3/8"Dr. Adapter x 1/4"M
- 3 Ext. 2 - 3 - 6"L
- 1 1/4" Hex Shank Handle
- 1 1/4"Dr. Folding Driver
- 1 3/8"Dr. Ratchet (380372)
- 9 Hex Key : 1.5 ~ 10mm
- 13 Combination :
10 - 12 - 13 - 15 - 17 - 18mm & SAE : 3/8 - 7/16 - 1/2 - 9/16 - 5/8 - 11/16 - 3/4"
- 3 Hex Bit Holder - Insert Bit Holder - 1/4" Hex Shank 1/4"Dr. Adapter
- 3 6" Linesman - 6" Longnose - 6" Diagonal Cutting

5600g 3 Sets / 19 Kgs / 2.06 CUFT



AC-234151 1/4", 3/8" 1/2" Dr. 151pcs Metric & SAE Master Set

- 25 1/4" Dr. Socket : 4 - 5 - 5.5 - 6 - 7 - 8 - 9 - 10 - 11 - 12mm 6 pt. 12 pt.
1/8 - 3/16 - 7/32 - 1/4 - 9/32 - 5/16 - 11/32"
- 32 3/8" Dr. Socket : 13 - 14 - 15 - 16 - 17 - 18 - 19mm
3/8 - 7/16 - 1/2 - 9/16 - 5/8 - 11/16 - 3/4 - 13/16 - 7/8"(12pt.)
- 3/8" Dr. Deep : 8 - 9 - 10 - 12 - 13 - 14 - 15 - 16 - 17 - 18 - 19mm
- 3/8" Dr. Star : E12 - E14 - E16 - E18 - E20
- 16 1/2" Dr. Socket : 20 - 21 - 22 - 24 - 27 - 30 - 32mm
15/16 - 1" - 1 1/16 - 1 1/4"(12pt.)
- 1/2" Dr. Impact Socket : 17 - 18 - 19 - 21 - 22mm
- 4 Slotted 3 - 4 - 5.5 - 6.5mm
- 4 Phillips #0 - 1 - 2 - 3
- 4 Posidriv #0 - 1 - 2 - 3
- 6 Hex 3 - 4 - 5 - 6 - 7 - 8mm
- 7 Star T10 - 15 - 20 - 25 - 27 - 30 - 40
- 11 Tamperproof Star T10 ~ 60
- 3 Universal Joint : 1/4" - 3/8" - 1/2"Dr.
- 2 Spark Plug Socket : 5/8 - 13/16"
- 5 Extension : 2 - 3 - 5 - 6 - 10"L
- 1 1/4" Hex Shank Screwdriver Handle
- 1 1/4"Dr. Socket Driver
- 3 Ratchet : 1/4" - 3/8" - 1/2"Dr.
- 9 Wobble Hex Key : 1.5 ~ 10mm
- 12 Combination : 8 - 9 - 10 - 11 - 12 - 13 - 14 - 15 - 16 - 17 - 18 - 19mm
- 3 Hex Bit Holder - Insert Bit Holder - 1/4"Dr. Adapter
- 3 6" Linesman - 6" Longnose - 6" Diagonal Cutting

11800g 2 Sets / 24.5 Kgs / 1.64 CUFT



Hand Sockets

3/4" Dr. Hand Sockets

6 pt. Metric Hand Sockets



ITEM NO.	Size mm	Length mm
625217	17	51
625218	18	51
625219	19	51
625220	20	51
625221	21	51
625222	22	51
625223	23	51
625224	24	51
625225	25	54
625226	26	54
625227	27	54
625228	28	54
625229	29	54
625230	30	54
625231	31	54
625232	32	57
625233	33	57
625234	34	57
625235	35	57
625236	36	57
625237	37	57
625238	38	57
625240	40	58
625241	41	58
625243	43	60
625245	45	63
625246	46	63
625248	48	65
625250	50	68
625252	52	70
625254	54	73
625255	55	73
625257	57	73
625258	58	73
625259	59	73
625260	60	80
625263	63	80
625265	65	85
625270	70	90

6 pt. Metric Deep Hand Sockets



ITEM NO.	Size mm	Length mm
629517	17	90
629518	18	90
629519	19	90
629520	20	90
629521	21	90
629522	22	90
629523	23	90
629524	24	90
629525	25	90
629526	26	90
629527	27	90
629528	28	90
629529	29	90
629530	30	90
629532	32	90
629533	33	90
629534	34	90
629535	35	90
629536	36	90
629538	38	90
629540	40	90
629541	41	90
629543	43	90
629545	45	95
629546	46	95
629548	48	100
629550	50	100

6 pt. SAE Hand Sockets



ITEM NO.	Size Inch	Length mm
685222	11/16	51
685224	3/4	51
685225	25/32	51
685226	13/16	51
685228	7/8	51
685230	15/16	51
685232	1	54
685234	1-1/16	54
685236	1-1/8	54
685238	1-3/16	54
685240	1-1/4	57
685242	1-5/16	57
685244	1-3/8	57
685246	1-7/16	57
685248	1-1/2	57
685250	1-9/16	58
685252	1-5/8	58

6 pt. SAE Deep Hand Sockets



ITEM NO.	Size Inch	Length mm
689522	11/16	90
689524	3/4	90
689525	25/32	90
689526	13/16	90
689528	7/8	90
689530	15/16	90
689532	1	90
689534	1-1/16	90
689536	1-1/8	90
689538	1-3/16	90
689540	1-1/4	90
689542	1-5/16	90
689544	1-3/8	90
689546	1-7/16	90
689548	1-1/2	90
689550	1-9/16	90
689552	1-5/8	90

continued on next column...

continued on next column...

3/4" Dr. Hand Sockets

6 pt. SAE Hand Sockets



ITEM NO.	Size Inch	Length mm
685254	1-11/16	60
685256	1-3/4	63
685258	1-13/16	63
685260	1-7/8	65
685262	1-15/16	65
685264	2	68
685266	2-1/16	70
685268	2-1/8	73
685270	2-3/16	73
685272	2-1/4	73
685274	2-5/16	73
685276	2-3/8	80
685280	2-1/2	80
685284	2-5/8	85
685288	2-3/4	90

6 pt. SAE Deep Hand Sockets



ITEM NO.	Size Inch	Length mm
689554	1-11/16	90
689556	1-3/4	95
689558	1-13/16	95
689560	1-7/8	100
689562	1-15/16	100
689564	2	100

12 pt. Metric Hand Sockets



ITEM NO.	Size mm	Length mm
635217	17	51
635218	18	51
635219	19	51
635220	20	51
635221	21	51
635222	22	51
635223	23	51
635224	24	51
635225	25	54
635226	26	54
635227	27	54
635228	28	54
635229	29	54
635230	30	54
635231	31	54
635232	32	57
635233	33	57
635234	34	57
635235	35	57
635236	36	57
635238	38	57
635240	40	58
635241	41	58
635243	43	60
635245	45	63
635246	46	63
635248	48	65
635250	50	68
635252	52	70
635254	54	73
635255	55	73
635257	57	73
635258	58	73
635259	59	73
635260	60	80
635263	63	80
635265	65	85
635270	70	90

12 pt. SAE Hand Sockets



ITEM NO.	Size Inch	Length mm
675222	11/16	51
675224	3/4	51
675225	25/32	51
675226	13/16	51
675228	7/8	51
675230	15/16	51
675232	1	54
675234	1-1/16	54
675236	1-1/8	54
675238	1-3/16	54
675240	1-1/4	57
675242	1-5/16	57
675244	1-3/8	57
675246	1-7/16	57
675248	1-1/2	57
675250	1-9/16	58
675252	1-5/8	58
675254	1-11/16	60
675256	1-3/4	63
675258	1-13/16	63
675260	1-7/8	65
675262	1-15/16	65
675264	2	68
675266	2-1/16	70
675268	2-1/8	73
675270	2-3/16	73
675272	2-1/4	73
675274	2-5/16	73
675276	2-3/8	80
675280	2-1/2	80
675284	2-5/8	85
675288	2-3/4	90

3/4" Dr. Accessories

A Ratchet with Plastic Handle		B Ratchet with Tube Handle	
ITEM NO.	Length mm	ITEM NO.	Length mm
680610S	610	680666R	500

C Ratchet Head with Tube Handle		D Ratchet Head	
ITEM NO.	Length mm	ITEM NO.	Length mm
680666RA	500	680666	290

E Hinge Handle		F Hinge Head with Tube Handle	
ITEM NO.	Length mm	ITEM NO.	Length mm
680446A	600	680446E	560

G Hinge Head		H Tube Handles	
ITEM NO.	Length mm	ITEM NO.	Length mm
680446	320	680350	350
		680580	580
		680850	850

I Sliding T-Handle		J L-Handle	
ITEM NO.	Length mm	ITEM NO.	Length mm
680060	500	620330L	330

K Adapters		L Extension Bars	
ITEM NO.	Female Drive	Male Drive	Length mm
620604	3/4"	1/2"	63
620608	3/4"	1"	65
ITEM NO.	Length mm (Inch)		
620100	100mm (4")		
620150	150mm (6")		
620200	200mm (8")		
620250	250mm (10")		
620400	400mm (16")		

M Universal Joint	
ITEM NO.	Length mm
680606	110

3/4" Dr. Socket Sets w/ Plastic Handle Ratchet

EU-615M 15pcs Metric Hand Socket Set	
11 3/4" Dr. Socket (625222 ~ 625250)	
22 - 24 - 27 - 30 - 32 - 33 - 34 - 36 - 41 - 46 - 50mm	
2 Ext. 200 - 400mmL (620200 ~ -400)	
1 Sliding T-Handle (680060)	
1 Ratchet (680610S)	
13000g 1 Sets / 14 Kgs / 0.91 CUFT	

3/4" Dr. Hand Socket Sets

GS-627M 27pcs Metric Hand Socket Set	
27 3/4" Dr. Socket (625217 ~ 625260)	
17 - 19 - 20 - 21 - 22 - 23 - 24 - 27 - 30 - 31 - 32 - 33 - 34 - 35 - 36 - 37 - 38 - 40 - 41 - 45 - 46 - 48 - 50 - 54 - 55 - 57 - 60mm	
16500g 1 Set / 18 Kgs / 0.91 CUFT	

SS-619S 19pcs SAE Hand Socket Set	
19 3/4" Dr. Socket (685224 ~ 685272)	
3/4 - 13/16 - 7/8 - 15/16 - 1" - 1 1/16 - 1 1/8 - 1 1/4 - 1 5/16 - 1 3/8 - 1 7/16 - 1 1/2 - 1 5/8 - 1 3/4 - 1 7/8 - 2" - 2 1/8 - 2 3/16 - 2 1/4"	
11000g 2 Sets / 23 Kgs / 0.92 CUFT	

GS-627S 27pcs SAE Hand Socket Set	
27 3/4" Dr. Socket (685224 ~ 685276)	
3/4 - 25/32 - 13/16 - 7/8 - 15/16 - 1" - 1 1/16 - 1 1/8 - 1 3/16 - 1 1/4 - 1 5/16 - 1 3/8 - 1 7/16 - 1 1/2 - 1 9/16 - 1 5/8 - 1 11/16 - 1 3/4 - 1 13/16 - 1 7/8 - 1 15/16 - 2" - 2 1/16 - 2 1/8 - 2 3/16 - 2 1/4 - 2 3/8"	
18000g 1 Set / 19 Kgs / 0.91 CUFT	

3/4" Dr. Socket Sets w/ Knurled Handle

GS-615M 15pcs Metric Hand Socket Set	
13 3/4" Dr. Socket (625227 ~ 625263)	
27 - 30 - 32 - 33 - 35 - 36 - 38 - 41 - 46 - 50 - 55 - 60 - 63mm	
1 Ext. 150mmL (620150)	
1 Sliding T-Handle (680060)	
12000g 1 Set / 13 Kgs / 0.46 CUFT	

GS-617M 17pcs Metric Hand Socket Set	
13 3/4" Dr. Socket (625221 ~ 625250)	
21 - 22 - 23 - 24 - 27 - 30 - 32 - 35 - 36 - 38 - 41 - 46 - 50mm	
2 Ext. 150 - 200mmL (620150 ~ -200)	
1 Sliding T-Handle (680060)	
1 Ratchet Head with Handle (680666R)	
12000g 1 Set / 13 Kgs / 0.46 CUFT	

TW-625M 25pcs Metric Hand Socket Set	
19 3/4" Dr. Socket (635219 ~ 635255)	
19 - 21 - 22 - 23 - 24 - 27 - 28 - 29 - 30 - 32 - 33 - 34 - 35 - 36 - 38 - 41 - 46 - 50 - 55mm	
2 Ext. 100 - 200mmL (620100 ~ -200)	
1 Sliding T-Handle (680060)	
1 Tube Handle (680350)	
1 Hinge Head (680446)	
1 Ratchet Head (680666)	
17500g 1 Set / 18.5 Kgs / 1.14 CUFT	

GS-615S 15pcs SAE Hand Socket Set	
13 3/4" Dr. Socket (685232 ~ 685280)	
1" - 1 1/8 - 1 1/4 - 1 3/8 - 1 1/2 - 1 5/8 - 1 3/4 - 1 7/8 - 2" - 2 1/8 - 2 1/4 - 2 3/8 - 2 1/2"	
1 Ext. 6"L (620150)	
1 Sliding T-Handle (680060)	
12000g 1 Set / 13 Kgs / 0.46 CUFT	

Hand Sockets

3/4" Dr. Socket Sets w/ Knurled Handle

GS-617S 17pcs SAE Hand Socket Set

13 3/4" Dr. Socket (685226 ~ 685260)
 13/16 - 7/8 - 15/16 - 1" - 1 1/16 -
 1 1/8 - 1 1/4 - 1 3/8 - 1 7/16 -
 1 1/2 - 1 5/8 - 1 3/4 - 1 7/8"

2 Ext. 6 - 8"L (620150 ~ -200)
 1 Sliding T-Handle (680060)
 1 Ratchet Head with Handle (680666R)

12000g 1 Set / 13 Kgs / 0.46 CUFT



TW-625S 25pcs SAE Hand Socket Set

19 3/4" Dr. Socket (675224 ~ 675272)
 3/4 - 13/16 - 7/8 - 15/16 - 1" - 1 1/16 -
 1 1/8 - 1 1/4 - 1 5/16 - 1 3/8 - 1 7/16 -
 1 1/2 - 1 5/8 - 1 3/4 - 1 7/8 - 2" -
 2 1/8 - 2 3/16 - 2 1/4"

2 Ext. 4 - 8"L (620100 ~ -200)
 1 Sliding T-Handle (680060)
 1 Tube Handle (680350)
 1 Hinge Head (680446)
 1 Ratchet Head (680666)

19000g 1 Set / 20 Kgs / 1.14 CUFT



TW-628MS 28pcs Metric & SAE Hand Socket Set

10 3/4" Dr. Socket (635222 ~ 635250)
 22 - 24 - 27 - 30 - 32 - 36 - 38 -
 41 - 46 - 50mm

12 3/4" Dr. Socket (685228 ~ 685264)
 7/8 - 15/16 - 1" - 1 1/8 - 1 3/16 -
 1 5/16 - 1 3/8 - 1 7/16 - 1 5/8 -
 1 3/4 - 1 7/8 - 2"

2 Ext. 4 - 8"L (620100 ~ -200)
 1 Sliding T-Handle (680060)
 1 Tube Handle (680350)
 1 Hinge Head (680446)
 1 Ratchet Head (680666)

19000g 1 Set / 20 Kgs / 1.14 CUFT



1" Dr. Hand Sockets

Metric Hand Sockets			SAE Hand Sockets		
ITEM NO.	Size mm	Length mm	ITEM NO.	Size Inch	Length mm
827021	21	60	887026	13/16	60
827022	22	60	887028	7/8	60
827023	23	60	887030	15/16	60
827024	24	60	887032	1	60
827025	25	60	887034	1-1/16	60
827026	26	60	887036	1-1/8	60
827027	27	60	887038	1-3/16	62
827028	28	60	887040	1-1/4	63
827029	29	60	887042	1-5/16	63
827030	30	62	887044	1-3/8	63
827032	32	63	887046	1-7/16	67
827033	33	63	887048	1-1/2	67
827034	34	63	887050	1-9/16	67
827035	35	63	887052	1-5/8	70
827036	36	67	887054	1-11/16	70
827038	38	67	887056	1-3/4	70
827040	40	67	887058	1-13/16	70
827041	41	70	887060	1-7/8	70
827043	43	70	887062	1-15/16	70
827046	46	70	887064	2	70
827048	48	70	887066	2-1/16	82
827050	50	70	887068	2-1/8	82
827052	52	82	887070	2-3/16	87
827054	54	82	887072	2-1/4	87
827055	55	87	887074	2-5/16	87
827057	57	87	887076	2-3/8	91
827058	58	87	887080	2-1/2	91
827059	59	87	887084	2-5/8	95
827060	60	91	887088	2-3/4	100
827063	63	91	887090	2-13/16	100
827065	65	95	887094	2-15/16	105
827067	67	95	887096	3	105
827070	70	100	887100	3-1/8	105
827071	71	100	887108	3-3/8	110
827075	75	105	887112	3-1/2	110
827077	77	105			
827080	80	105			
827082	82	110			
827085	85	110			
827090	90	110			
827095	95	115			
827100	100	115			

1" Dr. Accessories

	
A Ratchet with Tube Handle	B Hinge Head with Tube Handle
ITEM NO.	ITEM NO.
Length mm	Length mm
880888R	880846E
800	850
	
C Hinge Head	D Tube Handles
ITEM NO.	ITEM NO.
Length mm	Length mm
880846	680350
350	680580
	680850
	850

1" Dr. Hand Sockets

12 pt. Metric Hand Sockets



ITEM NO.	Size mm	Length mm
837021	21	60
837022	22	60
837023	23	60
837024	24	60
837025	25	60
837026	26	60
837027	27	60
837028	28	60
837029	29	60
837030	30	62
837032	32	63
837033	33	63
837034	34	63
837035	35	63
837036	36	67
837038	38	67
837040	40	67
837041	41	70
837043	43	70
837046	46	70
837048	48	70
837050	50	70
837052	52	82
837054	54	82
837055	55	87
837057	57	87
837058	58	87
837059	59	87
837060	60	91
837063	63	91
837065	65	95
837070	70	100
837075	75	105
837080	80	105
837085	85	110
837090	90	110

12 pt. SAE Hand Sockets



ITEM NO.	Size Inch	Length mm
877026	13/16	60
877028	7/8	60
877030	15/16	60
877032	1	60
877034	1-1/16	60
877036	1-1/8	60
877038	1-3/16	62
877040	1-1/4	63
877042	1-5/16	63
877044	1-3/8	63
877046	1-7/16	67
877048	1-1/2	67
877050	1-9/16	67
877052	1-5/8	70
877054	1-11/16	70
877056	1-3/4	70
877058	1-13/16	70
877060	1-7/8	70
877062	1-15/16	70
877064	2	70
877066	2-1/16	82
877068	2-1/8	82
877070	2-3/16	87
877072	2-1/4	87
877074	2-5/16	87
877076	2-3/8	91
877080	2-1/2	91
877084	2-5/8	95
877088	2-3/4	100
877090	2-13/16	100
877094	2-15/16	105
877096	3	105
877100	3-1/8	105
877108	3-3/8	110
877112	3-1/2	110

1" Dr. Accessories

E Sliding T-Handles

ITEM NO.	Length mm
880063	630
880080	750

F Adapters

ITEM NO.	Female Drive	Male Drive	Length mm
821006	1"	3/4"	70
821012	1"	1 1/2"	80

G Extension Bars

ITEM NO.	Length mm (Inch)
820150	150mm (6")
820200	200mm (8")
820250	250mm (10")
820400	400mm (16")

H Universal Joint

ITEM NO.	Length mm
880808	130

1" Dr. Hand Socket Sets

GS-817M 17pcs Metric Hand Socket Set

- 17 1" Dr. Socket (827024 ~ 827075)
- 24 - 27 - 30 - 32 - 33 - 35 - 36 - 38 - 41 - 46 - 50 - 54 - 55 - 60 - 65 - 70 - 75mm

1 Set / 21 Kgs / 1.41 CUFT

GS-817S 17pcs SAE Hand Socket Set

- 17 1" Dr. Socket (887046 ~ 887100)
- 1 7/16 - 1 1/2 - 1 5/8 - 1 11/16 - 1 3/4 - 1 13/16 - 1 7/8 - 2" - 2 1/8 - 2 3/16 - 2 1/4 - 2 3/8 - 2 1/2 - 2 5/8 - 2 3/4 - 2 15/16 - 3 1/8"

1 Set / 27 Kgs / 1.41 CUFT

1" Dr. Socket Sets w/ Knurled Handle

GS-815M 15pcs Metric Hand Socket Set

- 12 1" Dr. Socket (827030 ~ 827063)
- 30 - 32 - 33 - 35 - 36 - 38 - 41 - 46 - 50 - 55 - 60 - 63mm
- 2 Ext. 150 - 200mmL (820150 ~ 820200)
- 1 Ratchet Handle (880888R)

1 Set / 20 Kgs / 0.82 CUFT

GS-816M 16pcs Metric Hand Socket Set

- 7 1" Dr. Socket (837036 ~ 837055)
- 36 - 38 - 41 - 43 - 46 - 50 - 55mm
- 5 1" Dr. Socket (827060 ~ 827080)
- 60 - 65 - 70 - 75 - 80mm
- 2 Ext. 200 - 400mmL (820200 ~ 820400)
- 1 Sliding T-Handle (880063)
- 1 Ratchet Handle (880888R)

1 Set / 37 Kgs / 0.82 CUFT

GS-815S 15pcs SAE Hand Socket Set

- 12 1" Dr. Socket (887036 ~ 887080)
- 1 1/8 - 1 1/4 - 1 3/8 - 1 1/2 - 1 5/8 - 1 3/4 - 1 7/8 - 2" - 2 1/8 - 2 1/4 - 2 3/8 - 2 1/2"
- 2 Ext. 6 - 8"L (820150 ~ 820200)
- 1 Ratchet Handle (880888R)

1 Set / 21 Kgs / 0.82 CUFT

GS-816S 16pcs SAE Hand Socket Set

- 6 1" Dr. Socket (877046 ~ 877072)
- 1 7/16 - 1 1/2 - 1 11/16 - 1 7/8 - 2" - 2 1/4"
- 6 1" Dr. Socket (887076 ~ 887100)
- 2 3/8 - 2 1/2 - 2 5/8 - 2 3/4 - 2 15/16 - 3 1/8"
- 2 Ext. 8 - 16"L (820200 ~ 820400)
- 1 Sliding T-Handle (880063)
- 1 Ratchet Handle (880888R)

1 Set / 38 Kgs / 0.82 CUFT

Head Drivers

3/8" Dr. Head Drivers

Metric Hex Head Drivers

ITEM NO.	Size mm	Length mm
345204	4	52
345205	5	52
345206	6	52
345207	7	52
345208	8	52
345209	9	52
345210	10	52
345212	12	52
345214	14	52
345216	16	52
345217	17	52

346004	4	60
346005	5	60
346006	6	60
346007	7	60
346008	8	60
346009	9	60
346010	10	60
346012	12	60
346014	14	60
346016	16	60
346017	17	60

347604	4	76
347605	5	76
347606	6	76
347607	7	76
347608	8	76
347609	9	76
347610	10	76
347612	12	76
347614	14	76
347616	16	76
347617	17	76

Star Head Drivers

ITEM NO.	Size	Length mm
3452S10	T-10	52
3452S15	T-15	52
3452S20	T-20	52
3452S25	T-25	52
3452S27	T-27	52
3452S30	T-30	52
3452S40	T-40	52
3452S45	T-45	52
3452S50	T-50	52
3452S55	T-55	52
3452S60	T-60	52

3460S10	T-10	60
3460S15	T-15	60
3460S20	T-20	60
3460S25	T-25	60
3460S27	T-27	60
3460S30	T-30	60
3460S40	T-40	60
3460S45	T-45	60
3460S50	T-50	60
3460S55	T-55	60
3460S60	T-60	60

3476S10	T-10	76
3476S15	T-15	76
3476S20	T-20	76
3476S25	T-25	76
3476S27	T-27	76
3476S30	T-30	76
3476S40	T-40	76
3476S45	T-45	76
3476S50	T-50	76
3476S55	T-55	76
3476S60	T-60	76

SAE Hex Head Drivers

ITEM NO.	Size Inch	Length mm
365205	5/32	52
365206	3/16	52
365207	7/32	52
365208	1/4	52
365210	5/16	52
365212	3/8	52
365214	7/16	52
365216	1/2	52
365218	9/16	52
365220	5/8	52

Triple Square Head Drivers

ITEM NO.	Size	Length mm
3452T05	M5	52
3452T06	M6	52
3452T08	M8	52
3452T10	M10	52
3452T12	M12	52

3460T05	M5	60
3460T06	M6	60
3460T08	M8	60
3460T10	M10	60
3460T12	M12	60

3476T05	M5	76
3476T06	M6	76
3476T08	M8	76
3476T10	M10	76
3476T12	M12	76

3/8" Dr. Head Drivers

Slotted Head Drivers

ITEM NO.	T x W mm	Length mm
3452P055	1.0 x 5.5	52
3452P08	1.2 x 8.0	52
3452P10	1.6 x 10.0	52

3460P055	1.0 x 5.5	60
3460P08	1.2 x 8.0	60
3460P10	1.6 x 10.0	60

3476P055	1.0 x 5.5	76
3476P08	1.2 x 8.0	76
3476P10	1.6 x 10.0	76

Phillips Head Drivers

ITEM NO.	Size	Length mm
3452R01	#1	52
3452R02	#2	52
3452R03	#3	52
3452R04	#4	52

3460R01	#1	60
3460R02	#2	60
3460R03	#3	60
3460R04	#4	60

3476R01	#1	76
3476R02	#2	76
3476R03	#3	76
3476R04	#4	76

3/8" Dr. Head Driver Sets

TH-310M 10pcs Metric Hex Head Driver Set

10 3/8" Dr. Hex Head (345204 ~ -17)
4 - 5 - 6 - 7 - 8 - 10 - 12 - 14 - 16 - 17mm(52mmL)

900g 20 Sets / 19 Kgs / 0.88 CUFT

TH-310S 10pcs SAE Hex Head Driver Set

10 3/8" Dr. Hex Head (365205 ~ -20)
5/32 - 3/16 - 7/32 - 1/4 - 5/16 - 3/8 - 7/16 - 1/2 - 9/16 - 5/8" (52mmL)

900g 20 Sets / 19 Kgs / 0.88 CUFT

TX-311 11pcs Star Head Driver Set

11 3/8" Dr. Star Head (3460S10 ~ -S60)
T10 - 15 - 20 - 25 - 27 - 30 - 40 - 45 - 50 - 55 - 60(60mmL)

580g 40 Sets / 24.5 Kgs / 1.07 CUFT

TM-305 5pcs Triple Square Head Driver Set

5 3/8" Dr. Triple Square (3476T05 ~ T12)
M5 - 6 - 8 - 10 - 12(76mmL)

650g 20 Sets / 14 Kgs / 0.67 CUFT

TX-321 21pcs Star Head Driver Component Set

11 3/8" Dr. Star (3460S10 ~ -S60)
T10 - 15 - 20 - 25 - 27 - 30 - 40 - 45 - 50 - 55 - 60(60mmL)

3 3/8" Dr. Slotted (3460P055 ~ -P10)
5.5 - 8 - 10mm(60mmL)

4 3/8" Dr. Phillips (3460R01 ~ -R04)
#1 - 2 - 3 - 4(60mmL)

1 Extension 3"L (340075)

1 Sliding T-Handle (380030)

1 Ratchet (380333R)

2460g 6 Sets / 16 Kgs / 0.70 CUFT

1/2" Dr. Head Drivers



Metric Hex Head Drivers

ITEM NO.	Size mm	Length mm
446004	4	60
446005	5	60
446006	6	60
446007	7	60
446008	8	60
446009	9	60
446010	10	60
446012	12	60
446014	14	60
446016	16	60
446017	17	60
446019	19	60
446021	21	60



Star Head Drivers

ITEM NO.	Size	Length mm
4460S10	T-10	60
4460S15	T-15	60
4460S20	T-20	60
4460S25	T-25	60
4460S27	T-27	60
4460S30	T-30	60
4460S40	T-40	60
4460S45	T-45	60
4460S50	T-50	60
4460S55	T-55	60
4460S60	T-60	60
4460S70	T-70	60

447604	4	76
447605	5	76
447606	6	76
447607	7	76
447608	8	76
447609	9	76
447610	10	76
447612	12	76
447614	14	76
447616	16	76
447617	17	76
447619	19	76
447621	21	76

4476S10	T-10	76
4476S15	T-15	76
4476S20	T-20	76
4476S25	T-25	76
4476S27	T-27	76
4476S30	T-30	76
4476S40	T-40	76
4476S45	T-45	76
4476S50	T-50	76
4476S55	T-55	76
4476S60	T-60	76
4476S70	T-70	76



SAE Hex Head Drivers

ITEM NO.	Size Inch	Length mm
466005	5/32	60
466006	3/16	60
466007	7/32	60
466008	1/4	60
466010	5/16	60
466012	3/8	60
466014	7/16	60
466016	1/2	60
466018	9/16	60
466020	5/8	60
466022	11/16	60
466024	3/4	60
466026	13/16	60



Triple Square Head Drivers

ITEM NO.	Size	Length mm
4460T05	M05	60
4460T06	M06	60
4460T08	M08	60
4460T10	M10	60
4460T12	M12	60
4476T05	M05	76
4476T06	M06	76
4476T08	M08	76
4476T10	M10	76
4476T12	M12	76
4476T14	M14	76
4476T16	M16	76



Slotted Head Drivers

ITEM NO.	T x W mm	Length mm
4460P08	1.2 x 8.0	60
4460P10	1.6 x 10	60
4460P12	2.0 x 12	60
4460P14	2.5 x 14	60
4460P16	2.5 x 16	60



Philips Head Drivers

ITEM NO.	Size	Length mm
4460R01	#1	60
4460R02	#2	60
4460R03	#3	60
4460R04	#4	60
4476R01	#1	76
4476R02	#2	76
4476R03	#3	76
4476R04	#4	76

4476P08	1.2 x 8.0	76
4476P10	1.6 x 10	76
4476P12	2.0 x 12	76
4476P14	2.5 x 14	76
4476P16	2.5 x 16	76

1/2" Dr. Head Driver Sets

TH-408MD 8pcs Metric Hex Head Driver Set

8 1/2" Dr. Hex Head (447605 ~ 447619)
5 - 6 - 8 - 10 - 12 - 14 - 17 - 19mm(76mmL)

1150g 20 Sets / 24 Kgs / 0.73 CUFT

TH-411M 11pcs Metric Hex Head Driver Set

11 1/2" Dr. Hex Head (446005 ~ 446019)
5 - 6 - 7 - 8 - 9 - 10 - 12 - 14 - 16 - 17 - 19mm(60mmL)

1130g 12 Sets / 17 Kgs / 0.73 CUFT

TH-410S 10pcs SAE Hex Head Driver Set

10 1/2" Dr. Hex Head (466006 ~ 466024)
3/16 - 7/32 - 1/4 - 5/16 - 3/8 - 7/16 - 1/2 - 9/16 - 5/8 - 3/4" (60mmL)

1170g 12 Sets / 15 Kgs / 0.73 CUFT

TM-405 5pcs Triple Square Head Driver Set

5 1/2" Dr. Triple Square (4476T05 ~ T12)
M5 - 6 - 8 - 10 - 12(76mmL)

700g 20 Sets / 15 Kgs / 0.67 CUFT

3/4" Dr. Head Drivers



ITEM NO.	Size mm	Length mm
648819	19	88
648821	21	88
648822	22	88
648824	24	88
648827	27	88
648830	30	88
648832	32	88

ITEM NO.	Size Inch	Length mm
668824	3/4	88
668826	13/16	88
668828	7/8	88
668830	15/16	88
668832	1	88
668834	1-1/16	88
668836	1-1/8	88
668838	1-3/16	88
668840	1-1/4	88

1" Dr. Head Drivers



ITEM NO.	Size mm	Length mm
849819	19	98
849821	21	98
849822	22	98
849824	24	98
849826	26	98
849827	27	98
849830	30	98
849832	32	98
849833	33	98
849836	36	98

ITEM NO.	Size Inch	Length mm
869824	3/4	98
869826	13/16	98
869828	7/8	98
869830	15/16	98
869832	1	98
869834	1-1/16	98
869836	1-1/8	98
869838	1-3/16	98
869840	1-1/4	98
869842	1-5/16	98
869844	1-3/8	98

Head Drivers

3/4" Dr. Bit Sockets

Metric Hex Bit Sockets



ITEM NO.	Size mm	Length mm
619+2914	14	80
619+2916	16	80
619+2917	17	80
619+2918	18	80
619+2919	19	80
622+2922	22	85
622+2924	24	85
627+2927	27	90
627+2930	30	90
627+2932	32	90

SAE Hex Bit Sockets



ITEM NO.	Size Inch	Length mm
619+3936	9/16	80
619+3940	5/8	80
619+3948	3/4	80
622+3952	13/16	85
622+3956	7/8	85
622+3960	15/16	85
622+3964	1	85
627+3968	1-1/16	90
627+3972	1-1/8	90
627+3976	1-3/16	90
627+3980	1-1/4	90

Star Bit Sockets



ITEM NO.	Size	Length mm
619+6980	T-80	95
619+6990	T-90	95
619+6995	T-100	95

Triple Square Bit Sockets



ITEM NO.	Size	Length mm
619+9916	M16	95
619+9918	M18	95

3/4" Dr. Bit Socket Sets

BS-614H 14pcs Metric Hex Bit Socket Set

- 10 19mm Shank Hex Bit (2914 ~ -19)
14 - 16 - 17 - 18 - 19mm
22mm Shank Hex Bit (2922 ~ -24)
22 - 24mm
27mm Shank Hex Bit (2927 ~ -32)
27 - 30 - 32mm
- 3 3/4" Dr. Bit Holder : 19 - 22 - 27mm Shank
1 Hex Key : 4mm (570740)
- 3100g 8 Sets / 26 Kgs / 0.88 CUFT



BS-615H 15pcs SAE Hex Bit Socket Set

- 11 19mm Shank Hex Bit (3936 ~ -48)
9/16 - 5/8 - 3/4"
22mm Shank Hex Bit (3952 ~ -64)
13/16 - 7/8 - 15/16 - 1"
27mm Shank Hex Bit (3968 ~ -80)
1 1/16 - 1 1/8 - 1 3/16 - 1 1/4"
- 3 3/4" Dr. Bit Holder : 19 - 22 - 27mm Shank
1 Hex Key : 4mm (570740)
- 3500g 8 Sets / 29 Kgs / 0.88 CUFT



3/4" & 1" Dr. Bit Socket Sets

BS-6817H 17pcs 3/4" & 1" Drive Metric Hex Bit Socket Set

- 12 19mm Shank Hex Bit (2914 ~ -19)
14 - 16 - 17 - 18 - 19mm
22mm Shank Hex Bit (2922 ~ -24)
22 - 24mm
27mm Shank Hex Bit (2927 ~ -32)
27 - 30 - 32mm
32mm Shank Hex Bit (2933 ~ -36)
33 - 36mm
- 4 3/4" Dr. Bit Holder (619+ ~ 622+)
19 - 22mm Shank
1" Dr. Bit Holder (827+ ~ 832+)
27 - 32mm Shank
- 1 Hex Key : 4mm (570740)
- 5000g 4 Sets / 21 Kgs / 0.85 CUFT



1" Dr. Bit Sockets

Metric Hex Bit Sockets



ITEM NO.	Size mm	Length mm
819+2916	16	85
819+2917	17	85
819+2918	18	85
819+2919	19	85
822+2922	22	90
822+2924	24	90
827+2927	27	95
827+2930	30	95
827+2932	32	95
832+2933	33	100
832+2936	36	100

SAE Hex Bit Sockets



ITEM NO.	Size Inch	Length mm
819+3940	5/8	85
819+3948	3/4	85
822+3952	13/16	90
822+3956	7/8	90
822+3960	15/16	90
822+3964	1	90
827+3968	1-1/16	95
827+3972	1-1/8	95
827+3976	1-3/16	95
827+3980	1-1/4	95
832+3984	1-5/16	100
832+3988	1-3/8	100

1" Dr. Bit Socket Sets

BS-816H 16pcs Metric Hex Bit Socket Set

- 11 19mm Shank Hex Bit (2916 ~ -19)
16 - 17 - 18 - 19mm
22mm Shank Hex Bit (2922 ~ -24)
22 - 24mm
27mm Shank Hex Bit (2927 ~ -32)
27 - 30 - 32mm
32mm Shank Hex Bit (2933 ~ -36)
33 - 36mm
- 4 1" Dr. Bit Holder (819+ ~ 832+)
19 - 22 - 27 - 32mm Shank
- 1 Hex Key : 4mm (570740)
- 5200g 4 Sets / 22 Kgs / 0.85 CUFT

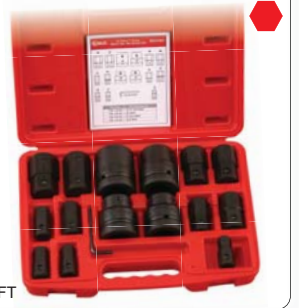

BS-817H 17pcs SAE Hex Bit Socket Set

- 12 19mm Shank Hex Bit (3940 ~ -48)
5/8 - 3/4"
22mm Shank Hex Bit (3952 ~ -64)
13/16 - 7/8 - 15/16 - 1"
27mm Shank Hex Bit (3968 ~ -80)
1 1/16 - 1 1/8 - 1 3/16 - 1 1/4"
32mm Shank Hex Bit (3984 ~ -88)
1 5/16 - 1 3/8"
- 4 1" Dr. Bit Holder (819+ ~ 832+)
19 - 22 - 27 - 32mm Shank
- 1 Hex Key : 4mm (570740)
- 5750g 4 Sets / 24 Kgs / 0.85 CUFT



BS-6818H 18pcs 3/4" & 1" Drive SAE Hex Bit Socket Set

- 12 19mm Shank Hex Bit (3936 ~ -48)
9/16 - 5/8 - 3/4"
22mm Shank Hex Bit (3952 ~ -64)
13/16 - 7/8 - 15/16 - 1"
27mm Shank Hex Bit (3968 ~ -80)
1 1/16 - 1 1/8 - 1 3/16 - 1 1/4"
32mm Shank Hex Bit (3984 ~ -88)
1 5/16 - 1 3/8"
- 4 3/4" Dr. Bit Holder (619+ ~ 622+)
19 - 22mm Shank
1" Dr. Bit Holder (827+ ~ 832+)
27 - 32mm Shank
- 1 Hex Key : 4mm (570740)
- 5500g 4 Sets / 23 Kgs / 0.85 CUFT



1/4" Dr. Bit Sockets

Slotted Bit Sockets



ITEM NO.	Size mm	Length mm
208+1130	0.5X3.0	45
208+1140	0.6X4.0	45
208+1150	0.8X5.0	45
208+1160	1.0X6.0	45

208+1330	0.5X3.0	70
208+1340	0.6X4.0	70
208+1350	0.8X5.0	70
208+1360	1.0X6.0	70

208+1530	0.5X3.0	100
208+1540	0.6X4.0	100
208+1550	0.8X5.0	100
208+1560	1.0X6.0	100

Philips Bit Sockets



ITEM NO.	Size	Length mm
208+1100	#0	45
208+1101	#1	45
208+1102	#2	45
208+1103	#3	45

208+1301	#1	70
208+1302	#2	70
208+1303	#3	70

208+1501	#1	100
208+1502	#2	100
208+1503	#3	100

Metric Hex Bit Sockets



ITEM NO.	Size mm	Length mm
208+2122	2	45
208+2125	2.5	45
208+2133	3	45
208+2134	4	45
208+2135	5	45
208+2136	6	45

208+2322	2	70
208+2325	2.5	70
208+2333	3	70
208+2334	4	70
208+2335	5	70
208+2336	6	70

208+2522	2	100
208+2525	2.5	100
208+2533	3	100
208+2534	4	100
208+2535	5	100
208+2536	6	100

SAE Hex Bit Sockets



ITEM NO.	Size Inch	Length mm
208+3104	1/16	45
208+3105	5/64	45
208+3106	3/32	45
208+3107	7/64	45
208+3108	1/8	45
208+3110	5/32	45
208+3112	3/16	45
208+3114	7/32	45
208+3116	1/4	45

208+3304	1/16	70
208+3305	5/64	70
208+3306	3/32	70
208+3307	7/64	70
208+3308	1/8	70
208+3310	5/32	70
208+3312	3/16	70
208+3314	7/32	70
208+3316	1/4	70

208+3504	1/16	100
208+3505	5/64	100
208+3506	3/32	100
208+3507	7/64	100
208+3508	1/8	100
208+3510	5/32	100
208+3512	3/16	100
208+3514	7/32	100
208+3516	1/4	100

SAE Wobble Bit Sockets



ITEM NO.	Size Inch	Length mm
208+5108	1/8	45
208+5110	5/32	45
208+5112	3/16	45
208+5114	7/32	45
208+5116	1/4	45

208+5308	1/8	70
208+5310	5/32	70
208+5312	3/16	70
208+5314	7/32	70
208+5316	1/4	70

208+5508	1/8	100
208+5510	5/32	100
208+5512	3/16	100
208+5514	7/32	100
208+5516	1/4	100

Metric Wobble Bit Sockets



ITEM NO.	Size mm	Length mm
208+4133	3	45
208+4134	4	45
208+4135	5	45
208+4136	6	45

208+4333	3	70
208+4334	4	70
208+4335	5	70
208+4336	6	70

208+4533	3	100
208+4534	4	100
208+4535	5	100
208+4536	6	100

1/4" Dr. Bit Sockets

Star Bit Sockets



ITEM NO.	Size	Length mm
208+6106	T-6	45
208+6107	T-7	45
208+6108	T-8	45
208+6109	T-9	45
208+6110	T-10	45
208+6115	T-15	45
208+6120	T-20	45
208+6125	T-25	45
208+6127	T-27	45
208+6130	T-30	45
208+6140	T-40	45

208+6306	T-6	70
208+6307	T-7	70
208+6308	T-8	70
208+6309	T-9	70
208+6310	T-10	70
208+6315	T-15	70
208+6320	T-20	70
208+6325	T-25	70
208+6327	T-27	70
208+6330	T-30	70
208+6340	T-40	70

208+6506	T-6	100
208+6507	T-7	100
208+6508	T-8	100
208+6509	T-9	100
208+6510	T-10	100
208+6515	T-15	100
208+6520	T-20	100
208+6525	T-25	100
208+6527	T-27	100
208+6530	T-30	100
208+6540	T-40	100

Tamperproof Star Bit Sockets



ITEM NO.	Size	Length mm
208+7107	T-7	45
208+7108	T-8	45
208+7109	T-9	45
208+7110	T-10	45
208+7115	T-15	45
208+7120	T-20	45
208+7125	T-25	45
208+7127	T-27	45
208+7130	T-30	45
208+7140	T-40	45

208+7307	T-7	70
208+7308	T-8	70
208+7309	T-9	70
208+7310	T-10	70
208+7315	T-15	70
208+7320	T-20	70
208+7325	T-25	70
208+7327	T-27	70
208+7330	T-30	70
208+7340	T-40	70

208+7507	T-7	100
208+7508	T-8	100
208+7509	T-9	100
208+7510	T-10	100
208+7515	T-15	100
208+7520	T-20	100
208+7525	T-25	100
208+7527	T-27	100
208+7530	T-30	100
208+7540	T-40	100

Triple Square Bit Sockets



ITEM NO.	Size	Length mm
208+8104	M4	45
208+8105	M5	45
208+8106	M6	45

208+8304	M4	70
208+8305	M5	70
208+8306	M6	70

208+8504	M4	100
208+8505	M5	100
208+8506	M6	100

Spanner Bit Sockets



ITEM NO.	Size	Length mm
208+9054	SP4	45
208+9056	SP6	45
208+9058	SP8	45
208+9060	SP10	45
208+9062	SP12	45
208+9064	SP14	45

208+9254	SP4	70
208+9256	SP6	70
208+9258	SP8	70
208+9260	SP10	70
208+9262	SP12	70
208+9264	SP14	70

1/4" Dr. Bit Sockets are also available in 100mmL & 140mmL. Please contact us for more details.

Bit Sockets

1/4" Dr. Bit Sockets

Pentacle Bit Sockets



ITEM NO.	Size	Length mm
208+5008	T-8	45
208+5010	T-10	45
208+5015	T-15	45
208+5020	T-20	45
208+5025	T-25	45
208+5027	T-27	45
208+5030	T-30	45

Ribe Bit Sockets



ITEM NO.	Size	Length mm
208+9004	M4	45
208+9005	M5	45
208+9006	M6	45
208+9204	M4	70
208+9205	M5	70
208+9206	M6	70

208+5208	T-8	70
208+5210	T-10	70
208+5215	T-15	70
208+5220	T-20	70
208+5225	T-25	70
208+5227	T-27	70
208+5230	T-30	70

208+5408	T-8	100
208+5410	T-10	100
208+5415	T-15	100
208+5420	T-20	100
208+5425	T-25	100
208+5427	T-27	100
208+5430	T-30	100

1/4" Dr. Bit Sockets

BS-207S 7pcs Slotted & Philips Bit Socket Set

4 1/4" Dr. Slotted (208+1130 ~ -1160)
3 - 4 - 5 - 6mm (45mmL)

3 1/4" Dr. Philips (208+1101 ~ -1103)
#1 - 2 - 3 (45mmL)

240g 60 Sets / 15.5 Kgs / 0.92 CUFT

BS-207L 7pcs Slotted & Philips Bit Socket Set

4 1/4" Dr. Slotted (208+1530 ~ -1560)
3 - 4 - 5 - 6mm (100mmL)

3 1/4" Dr. Philips (208+1501 ~ -1503)
#1 - 2 - 3 (100mmL)

345g 36 Sets / 13.5 Kgs / 0.92 CUFT

BS-206S 6pcs Spanner Bit Socket Set

6 1/4" Dr. Spanner (208+9054 ~ -9064)
SP4 - 6 - 8 - 10 - 12 - 14 (45mmL)

160g 60 Sets / 11 Kgs / 0.92 CUFT

3/8" Dr. Bit Sockets

Slotted Bit Sockets



ITEM NO.	Size mm	Length mm
308+1140	0.6X4.0	50
308+1150	0.8X5.0	50
308+1160	1.0X6.0	50
310+1280	1.2X8.0	50
310+1290	1.6X9.0	50

308+1540	0.6X4.0	110
308+1550	0.8X5.0	110
308+1560	1.0X6.0	110
310+1580	1.2X8.0	110
310+1590	1.6X9.0	110

308+1640	0.6X4.0	140
308+1650	0.8X5.0	140
308+1660	1.0X6.0	140
310+1680	1.2X8.0	140
310+1690	1.6X9.0	140

Philips Bit Sockets



ITEM NO.	Size	Length mm
308+1101	#1	50
308+1102	#2	50
308+1103	#3	50
310+1124	#4	50

308+1501	#1	110
308+1502	#2	110
308+1503	#3	110
310+1504	#4	110

308+1601	#1	140
308+1602	#2	140
308+1603	#3	140
310+1604	#4	140

Metric Hex Bit Sockets



ITEM NO.	Size mm	Length mm
308+2133	3	50
308+2134	4	50
308+2135	5	50
308+2136	6	50
310+2147	7	50
310+2148	8	50
339+2149	9	50
340+2150	10	50
341+2151	11	50
342+2152	12	50

308+2533	3	110
308+2534	4	110
308+2535	5	110
308+2536	6	110
310+2547	7	110
310+2548	8	110
339+2549	9	110
340+2550	10	110
341+2551	11	110
342+2552	12	110

308+2633	3	140
308+2634	4	140
308+2635	5	140
308+2636	6	140
310+2647	7	140
310+2648	8	140
339+2649	9	140
340+2650	10	140
341+2651	11	140
342+2652	12	140

SAE Hex Bit Sockets



ITEM NO.	Size Inch	Length mm
308+3108	1/8	50
308+3110	5/32	50
308+3112	3/16	50
308+3114	7/32	50
308+3116	1/4	50
310+3128	9/32	50
310+3130	5/16	50
312+3134	3/8	50
314+3138	7/16	50
316+3142	1/2	50

308+3508	1/8	110
308+3510	5/32	110
308+3512	3/16	110
308+3514	7/32	110
308+3516	1/4	110
310+3518	9/32	110
310+3520	5/16	110
312+3524	3/8	110
314+3528	7/16	110
316+3532	1/2	110

308+3608	1/8	140
308+3610	5/32	140
308+3612	3/16	140
308+3614	7/32	140
308+3616	1/4	140
310+3618	9/32	140
310+3620	5/16	140
312+3624	3/8	140
314+3628	7/16	140
316+3632	1/2	140

3/8" Dr. Bit Sockets

Metric Wobble Bit Sockets



ITEM NO.	Size mm	Length mm
308+4133	3	50
308+4134	4	50
308+4135	5	50
308+4136	6	50
310+4147	7	50
310+4148	8	50
339+4149	9	50
340+4150	10	50

SAE Wobble Bit Sockets



ITEM NO.	Size Inch	Length mm
308+5108	1/8	50
308+5110	5/32	50
308+5112	3/16	50
308+5114	7/32	50
308+5116	1/4	50
310+5118	9/32	50
310+5120	5/16	50
312+5124	3/8	50

308+4533	3	110
308+4534	4	110
308+4535	5	110
308+4536	6	110
310+4547	7	110
310+4548	8	110
339+4549	9	110
340+4550	10	110

308+5508	1/8	110
308+5510	5/32	110
308+5512	3/16	110
308+5514	7/32	110
308+5516	1/4	110
310+5518	9/32	110
310+5520	5/16	110
312+5524	3/8	110

308+4633	3	140
308+4634	4	140
308+4635	5	140
308+4636	6	140
310+4647	7	140
310+4648	8	140
339+4649	9	140
340+4650	10	140

308+5608	1/8	140
308+5610	5/32	140
308+5612	3/16	140
308+5614	7/32	140
308+5616	1/4	140
310+5618	9/32	140
310+5620	5/16	140
312+5624	3/8	140

Star Bit Sockets



ITEM NO.	Size	Length mm
308+6110	T-10	50
308+6115	T-15	50
308+6120	T-20	50
308+6125	T-25	50
308+6127	T-27	50
308+6130	T-30	50
308+6140	T-40	50
310+6245	T-45	50
310+6250	T-50	50
340+6255	T-55	50

Tamperproof Star Bit Sockets



ITEM NO.	Size	Length mm
308+7110	T-10	50
308+7115	T-15	50
308+7120	T-20	50
308+7125	T-25	50
308+7127	T-27	50
308+7130	T-30	50
308+7140	T-40	50
310+7145	T-45	50
310+7150	T-50	50
340+7155	T-55	50

308+6510	T-10	110
308+6515	T-15	110
308+6520	T-20	110
308+6525	T-25	110
308+6527	T-27	110
308+6530	T-30	110
308+6540	T-40	110
310+6545	T-45	110
310+6550	T-50	110
340+6555	T-55	110

308+7510	T-10	110
308+7515	T-15	110
308+7520	T-20	110
308+7525	T-25	110
308+7527	T-27	110
308+7530	T-30	110
308+7540	T-40	110
310+7545	T-45	110
310+7550	T-50	110
340+7555	T-55	110

308+6610	T-10	140
308+6615	T-15	140
308+6620	T-20	140
308+6625	T-25	140
308+6627	T-27	140
308+6630	T-30	140
308+6640	T-40	140
310+6645	T-45	140
310+6650	T-50	140
340+6655	T-55	140

308+7610	T-10	140
308+7615	T-15	140
308+7620	T-20	140
308+7625	T-25	140
308+7627	T-27	140
308+7630	T-30	140
308+7640	T-40	140
310+7645	T-45	140
310+7650	T-50	140
340+7655	T-55	140

3/8" Dr. Bit Sockets

Triple Square Bit Sockets



ITEM NO.	Size	Length mm
308+8104	M4	50
308+8105	M5	50
308+8106	M6	50
310+8108	M8	50
340+8110	M10	50
342+8112	M12	50
344+8114	M14	50

308+8504	M4	110
308+8505	M5	110
308+8506	M6	110
310+8508	M8	110
340+8510	M10	110
342+8512	M12	110
344+8514	M14	110

308+8604	M4	140
308+8605	M5	140
308+8606	M6	140
310+8608	M8	140
340+8610	M10	140
342+8612	M12	140
344+8614	M14	140

Pentacle Bit Sockets



ITEM NO.	Size	Length mm
308+5008	T-8	50
308+5010	T-10	50
308+5015	T-15	50
308+5020	T-20	50
308+5025	T-25	50
308+5027	T-27	50
308+5030	T-30	50
310+5040	T-40	50
310+5045	T-45	50
340+5050	T-50	50
342+5055	T-55	50

308+5408	T-8	110
308+5410	T-10	110
308+5415	T-15	110
308+5420	T-20	110
308+5425	T-25	110
308+5427	T-27	110
308+5430	T-30	110
310+5440	T-40	110
310+5445	T-45	110
340+5450	T-50	110
342+5455	T-55	110

Ribe Bit Sockets



ITEM NO.	Size	Length mm
308+9004	M4	50
308+9005	M5	50
308+9006	M6	50
310+9007	M7	50
310+9008	M8	50
340+9009	M9	50
340+9010	M10	50
342+9012	M12	50
344+9013	M13	50
344+9014	M14	50



308+9404	M4	110
308+9405	M5	110
308+9406	M6	110
310+9407	M7	110
310+9408	M8	110
340+9409	M9	110
340+9410	M10	110
342+9412	M12	110
344+9413	M13	110
344+9414	M14	110



3/8" Dr. Bit Sockets are also available in 180mmL & 220mmL. Please contact us for more details.



Bit Sockets

3/8" Dr. Bit Socket Sets

BS-309S 9pcs Slotted & Phillips Bit Socket Set



5  3/8" Dr. Slotted (308+1140 ~ -1290)
4 - 5 - 6 - 8 - 9mm (50mmL) 



4  3/8" Dr. Phillips (308+1101 ~ -1124)
#1 - 2 - 3 - 4 (50mmL) 



 485g  20 Sets / 11 Kgs / 0.73 CUFT



BS-309L 9pcs Slotted & Phillips Bit Socket Set



5  3/8" Dr. Slotted (308+1540 ~ -1590)
4 - 5 - 6 - 8 - 9mm (110mmL) 

4  3/8" Dr. Phillips (308+1501 ~ -1504)
#1 - 2 - 3 - 4 (110mmL) 



 640g  20 Sets / 14 Kgs / 0.73 CUFT



BS-310HM 10pcs Metric Hex Bit Socket Set

10  3/8" Dr. Hex (308+2133 ~ -2152) 

3 - 4 - 5 - 6 - 7 - 8 - 9 - 10 -
11 - 12mm (50mmL)

 635g  20 Sets / 14 Kgs / 0.73 CUFT



BS-310HML 10pcs Metric Hex Bit Socket Set



10  3/8" Dr. Hex (308+2533 ~ -2552) 

3 - 4 - 5 - 6 - 7 - 8 - 9 - 10 -
11 - 12mm (110mmL)



 900g  20 Sets / 19 Kgs / 0.73 CUFT



BS-310HS 10pcs SAE Hex Bit Socket Set



10  3/8" Dr. Hex (308+3108 ~ -3142) 

1/8 - 5/32 - 3/16 - 7/32 - 1/4 -
9/32 - 5/16 - 3/8 - 7/16 - 1/2"
(50mmL)



 630g  20 Sets / 14 Kgs / 0.73 CUFT



BS-310HSL 10pcs SAE Hex Bit Socket Set



10  3/8" Dr. Hex (308+3608 ~ -3632) 

1/8 - 5/32 - 3/16 - 7/32 - 1/4 -
9/32 - 5/16 - 3/8 - 7/16 - 1/2"
(140mmL)



 1090g  20 Sets / 23 Kgs / 0.73 CUFT



BS-308WH 8pcs Metric Wobble Hex Bit Socket Set



8  3/8" Dr. Wobble (308+4133 ~ -4150) 

3 - 4 - 5 - 6 - 7 - 8 - 9 -
10mm (50mmL)



 480g  36 Sets / 19 Kgs / 0.64 CUFT



BS-308WHL 8pcs Metric Wobble Hex Bit Socket

8  3/8" Dr. Wobble (308+4633 ~ -4650) 

3 - 4 - 5 - 6 - 7 - 8 - 9 -
10mm (140mmL)

 780g  20 Sets / 16 Kgs / 0.73 CUFT



3/8" Dr. Bit Socket Sets

BS-308WHS 8pcs SAE Wobble Hex Bit Socket Set



8  3/8" Dr. Wobble (308+5108 ~ -5124) 

1/8 - 5/32 - 3/16 - 7/32 - 1/4 -
9/32 - 5/16 - 3/8" (50mmL)



 470g  36 Sets / 18 Kgs / 0.64 CUFT



BS-308WSL 8pcs SAE Wobble Hex Bit Socket Set



8  3/8" Dr. Wobble (308+5508 ~ -5524) 

1/8 - 5/32 - 3/16 - 7/32 - 1/4 -
9/32 - 5/16 - 3/8" (110mmL)



 620g  20 Sets / 13 Kgs / 0.73 CUFT



BS-310T 10pcs Star Bit Socket Set



10  3/8" Dr. Star (308+6110 ~ -6255) 

T10 - 15 - 20 - 25 - 27 - 30 -
40 - 45 - 50 - 55 (50mmL)



 540g  20 Sets / 12 Kgs / 0.73 CUFT



BS-310TL 10pcs Star Bit Socket Set



10  3/8" Dr. Star (308+6510 ~ -6555) 

T10 - 15 - 20 - 25 - 27 - 30 -
40 - 45 - 50 - 55 (110mmL)



 725g  20 Sets / 15.5 Kgs / 0.73 CUFT



BS-310TA 10pcs Tamperproof Star Bit Socket Set



10  3/8" Dr. Tamperproof Star (308+7110 ~ -7155) 

T10 - 15 - 20 - 25 - 27 - 30 -
40 - 45 - 50 - 55 (50mmL)



 540g  20 Sets / 12 Kgs / 0.73 CUFT



BS-310TAL 10pcs Tamperproof Star Bit Socket Set

10  3/8" Dr. Tamperproof Star (308+7510 ~ -7555) 

T10 - 15 - 20 - 25 - 27 - 30 -
40 - 45 - 50 - 55 (110mmL)

 730g  20 Sets / 16 Kgs / 0.73 CUFT



BS-307M 7pcs Triple Square Bit Socket Set



7  3/8" Dr. Triple Square (308+8104 ~ -8114) 

M4 - 5 - 6 - 8 - 10 - 12 -
14 (50mmL)



 495g  20 Sets / 11 Kgs / 0.73 CUFT



BS-307ML 7pcs Triple Square Bit Socket Set

7  3/8" Dr. Triple Square (308+8504 ~ -8514) 

M4 - 5 - 6 - 8 - 10 - 12 - 14 (110mmL)

 720g  20 Sets / 15.5 Kgs / 0.73CUFT



3/8" Dr. Bit Socket Sets

BS-311PL 11pcs Pentacle Bit Socket Set

11  3/8" Dr. Pentacle
(308+5408 ~ -5455)
T8 - 10 - 15 - 20 - 25 - 27 - 30 -
40 - 45 - 50 - 55 (110mmL)



 850g  20 Sets / 18 Kgs / 0.73 CUFT

1/4" & 3/8" Dr. Bit Socket Sets

BS-2324HL 24pcs Metric Hex Bit Socket Set



12  1/4" Dr. Hex (208+2122 ~ -2136)
2 - 2.5 - 3 - 4 - 5 - 6mm
(45mmL)

1/4" Dr. Hex (208+2622 ~ -2636)
2 - 2.5 - 3 - 4 - 5 - 6mm
(140mmL)

12  3/8" Dr. Hex (310+2147 ~ -2152)
7 - 8 - 9 - 10 - 11 - 12mm
(50mmL)

3/8" Dr. Hex (310+2647 ~ -2652)
7 - 8 - 9 - 10 - 11 - 12mm
(140mmL)



 1710g  10 Sets / 18 Kgs / 1.16 CUFT

BS-2328HL 28pcs SAE Hex Bit Socket Set



18  1/4" Dr. Hex (208+3104 ~ -3116)
1/16 - 5/64 - 3/32 - 7/64 - 1/8 -
5/32 - 3/16 - 7/32 - 1/4" (45mmL)

1/4" Dr. Hex (208+3604 ~ -3616)
1/16 - 5/64 - 3/32 - 7/64 - 1/8 -
5/32 - 3/16 - 7/32 - 1/4" (140mmL)

10  3/8" Dr. Hex (310+3128 ~ -3142)
9/32 - 5/16 - 3/8 - 7/16 - 1/2"
(50mmL)

3/8" Dr. Hex (310+3618 ~ -3632)
9/32 - 5/16 - 3/8 - 7/16 - 1/2"
(140mmL)



 1790g  10 Sets / 19 Kgs / 1.16 CUFT

BS-2316WH 16pcs Metric Wobble Hex Bit Socket Set

8  1/4" Dr. Wobble (208+4133 ~ -4136)
3 - 4 - 5 - 6mm
(45mmL)

1/4" Dr. Wobble (208+4633 ~ -4636)
3 - 4 - 5 - 6mm
(140mmL)

8  3/8" Dr. Wobble (310+4147 ~ -4150)
7 - 8 - 9 - 10mm (50mmL)

3/8" Dr. Wobble (310+4647 ~ -4650)
7 - 8 - 9 - 10mm (140mmL)



 1200g  10 Sets / 13 Kgs / 0.82 CUFT

BS-2316WS 16pcs SAE Wobble Hex Bit Socket Set



10  1/4" Dr. Wobble (208+5108 ~ -5116)
1/8 - 5/32 - 3/16 - 7/32 - 1/4"
(45mmL)

1/4" Dr. Wobble (208+5608 ~ -5616)
1/8 - 5/32 - 3/16 - 7/32 - 1/4"
(140mmL)

6  3/8" Dr. Wobble (310+5118 ~ -5124)
9/32 - 5/16 - 3/8" (50mmL)

3/8" Dr. Wobble (310+5618 ~ -5624)
9/32 - 5/16 - 3/8" (140mmL)



 1100g  10 Sets / 12 Kgs / 0.82 CUFT

1/4" & 3/8" Dr. Bit Socket Sets

BS-2328TL 28pcs Star Bit Socket Set



22  1/4" Dr. Star (208+6106 ~ -6140)
T6 - 7 - 8 - 9 - 10 - 15 - 20 -
25 - 27 - 30 - 40 (45mmL)

1/4" Dr. Star (208+6606 ~ -6640)
T6 - 7 - 8 - 9 - 10 - 15 - 20 -
25 - 27 - 30 - 40 (140mmL)

6  3/8" Dr. Star (310+6245 ~ -6255)
T45 - 50 - 55
(50mmL)

3/8" Dr. Star (310+6645 ~ -6655)
T45 - 50 - 55
(140mmL)



 1590g  10 Sets / 17 Kgs / 1.16 CUFT

BS-2326TAL 26pcs Tamperproof Star Bit Socket Set



20  1/4" Dr. Tamperproof Star (208+7107 ~ -7140)
T7 - 8 - 9 - 10 - 15 - 20 -
25 - 27 - 30 - 40 (45mmL)

1/4" Dr. Tamperproof Star (208+7607 ~ -7640)
T7 - 8 - 9 - 10 - 15 - 20 -
25 - 27 - 30 - 40 (140mmL)

6  3/8" Dr. Tamperproof Star
(310+7145 ~ -7155)
T45 - 50 - 55 (50mmL)

3/8" Dr. Tamperproof Star
(310+7645 ~ -7655)
T45 - 50 - 55 (140mmL)



 1530g  10 Sets / 16.5 Kgs / 1.16 CUFT

BS-2314TR 14pcs Triple Square Bit Socket Set



6  1/4" Dr. Triple Square (208+8104 ~ -8106)
M4 - 5 - 6 (45mmL)

1/4" Dr. Triple Square (208+8604 ~ -8606)
M4 - 5 - 6 (140mmL)

8  3/8" Dr. Triple Square
(310+8108 ~ -8114)
M8 - 10 - 12 - 14 (50mmL)

3/8" Dr. Triple Square
(310+8608 ~ -8614)
M8 - 10 - 12 - 14 (140mmL)



 1260g  10 Sets / 13.5 Kgs / 0.82 CUFT

BS-23441 41pcs 1/4", 3/8" & 1/2" Dr. Complete Star Bit Socket

A complete collection of e-star and star bit sockets. This set is tailored for star or tamperproof star screws and nuts that can be found on most of vehicles.

Includes

12 E-Star Sockets
1/4"Dr. E4 - 5 - 6 - 7 - 8
3/8"Dr. E10 - 11 - 12 - 14 - 16
1/2"Dr. E18 - 20

15 Star Bit Sockets
1/4"Dr. T7 - 8 - 9 - 10 - 15 - 20 - 25 -
27 - 30 (45mmL)
3/8"Dr. T40 - 45 - 50 - 55 (50mmL)
1/2"Dr. T60 - 70 (62mmL)

14 Tamperproof Star Bit Sockets
1/4"Dr. T8 - 9 - 10 - 15 - 20 - 25 - 27 -
30 (45mmL)
3/8"Dr. T40 - 45 - 50 - 55 (50mmL)
1/2"Dr. T60 - 70 (62mmL)



Bit Sockets

1/2" Dr. Bit Sockets



Slotted Bit Sockets

ITEM NO.	Size mm	Length mm
408+1165	1.0X6.5	55
408+1170	1.2X7.0	55
410+1280	1.2X8.0	55
410+1290	1.6X9.0	55
440+1292	2.0X12.0	60
442+1294	2.5X14.0	60
444+1296	2.5X16.0	60

410+1480	1.2X8.0	80
410+1490	1.6X9.0	80
440+1492	2.0X12.0	80
442+1494	2.5X14.0	80
444+1496	2.5X16.0	80

410+1580	1.2X8.0	110
410+1590	1.6X9.0	110
440+1592	2.0X12.0	110
442+1594	2.5X14.0	110
444+1596	2.5X16.0	110



Philips Bit Sockets

ITEM NO.	Size	Length mm
408+1102	#2	55
408+1103	#3	55
410+1124	#4	55

408+1302	#2	80
408+1303	#3	80
410+1404	#4	80

408+1502	#2	110
408+1503	#3	110
410+1504	#4	110



Metric Hex Bit Sockets

ITEM NO.	Size mm	Length mm
408+2134	4	55
408+2135	5	55
408+2136	6	55
410+2147	7	55
410+2148	8	55
439+2149	9	55
440+2150	10	55
441+2151	11	55
442+2152	12	55

408+2334	4	80
408+2335	5	80
408+2336	6	80
410+2347	7	80
410+2348	8	80
439+2349	9	80
440+2350	10	80
441+2351	11	80
442+2352	12	80
443+2353	13	80
444+2354	14	80
446+2356	16	80
447+2357	17	80
449+2359	19	80

408+2534	4	110
408+2535	5	110
408+2536	6	110
410+2547	7	110
410+2548	8	110
439+2549	9	110
440+2550	10	110
441+2551	11	110
442+2552	12	110
443+2553	13	110
444+2554	14	110
446+2556	16	110
447+2557	17	110
449+2559	19	110



SAE Hex Bit Sockets

ITEM NO.	Size Inch	Length mm
408+3112	3/16	55
408+3114	7/32	55
408+3116	1/4	55
410+3128	9/32	55
410+3130	5/16	55
412+3134	3/8	55
414+3138	7/16	55
416+3142	1/2	55

408+3310	5/32	80
408+3312	3/16	80
408+3314	7/32	80
408+3316	1/4	80
410+3318	9/32	80
410+3320	5/16	80
412+3324	3/8	80
414+3328	7/16	80
416+3332	1/2	80
418+3336	9/16	80
420+3340	5/8	80
422+3344	11/16	80
424+3348	3/4	80

408+3510	5/32	110
408+3512	3/16	110
408+3514	7/32	110
408+3516	1/4	110
410+3518	9/32	110
410+3520	5/16	110
412+3524	3/8	110
414+3528	7/16	110
416+3532	1/2	110
418+3536	9/16	110
420+3540	5/8	110
422+3544	11/16	110
424+3548	3/4	110

1/2" Dr. Bit Sockets



Star Bit Sockets

ITEM NO.	Size	Length mm
408+6120	T-20	55
408+6125	T-25	55
408+6127	T-27	55
408+6130	T-30	55
408+6140	T-40	55
410+6245	T-45	55
410+6250	T-50	55
440+6255	T-55	55
442+6260	T-60	60
444+6270	T-70	60

408+6320	T-20	80
408+6325	T-25	80
408+6327	T-27	80
408+6330	T-30	80
408+6340	T-40	80
410+6345	T-45	80
410+6350	T-50	80
440+6355	T-55	80
442+6360	T-60	80
444+6370	T-70	80

408+6520	T-20	110
408+6525	T-25	110
408+6527	T-27	110
408+6530	T-30	110
408+6540	T-40	110
410+6545	T-45	110
410+6550	T-50	110
440+6555	T-55	110
442+6560	T-60	110
444+6570	T-70	110



Tamperproof Star Bit Sockets

ITEM NO.	Size	Length mm
408+7120	T-20	55
408+7125	T-25	55
408+7127	T-27	55
408+7130	T-30	55
408+7140	T-40	55
410+7145	T-45	55
410+7150	T-50	55
440+7155	T-55	55
442+7160	T-60	60
444+7170	T-70	60

408+7320	T-20	80
408+7325	T-25	80
408+7327	T-27	80
408+7330	T-30	80
408+7340	T-40	80
410+7345	T-45	80
410+7350	T-50	80
440+7355	T-55	80
442+7360	T-60	80
444+7370	T-70	80

408+7520	T-20	110
408+7525	T-25	110
408+7527	T-27	110
408+7530	T-30	110
408+7540	T-40	110
410+7545	T-45	110
410+7550	T-50	110
440+7555	T-55	110
442+7560	T-60	110
444+7570	T-70	110



Triple Square Bit Sockets

ITEM NO.	Size	Length mm
408+8104	M4	55
408+8105	M5	55
408+8106	M6	55
410+8108	M8	55
440+8110	M10	55
442+8112	M12	55
444+8114	M14	55
446+8116	M16	60
449+8118	M18	60

408+8304	M4	80
408+8305	M5	80
408+8306	M6	80
410+8308	M8	80
440+8310	M10	80
442+8312	M12	80
444+8314	M14	80
446+8316	M16	80

408+8504	M4	110
408+8505	M5	110
408+8506	M6	110
410+8508	M8	110
440+8510	M10	110
442+8512	M12	110
444+8514	M14	110
446+8516	M16	110



Pentacle Bit Sockets

ITEM NO.	Size	Length mm
408+5020	T-20	55
408+5025	T-25	55
408+5027	T-27	55
408+5030	T-30	55
410+5040	T-40	55
410+5045	T-45	55
440+5050	T-50	55
442+5055	T-55	55

408+5220	T-20	80
408+5225	T-25	80
408+5227	T-27	80
408+5230	T-30	80
410+5240	T-40	80
410+5245	T-45	80
440+5250	T-50	80
442+5255	T-55	80

408+5420	T-20	110
408+5425	T-25	110
408+5427	T-27	110
408+5430	T-30	110
410+5440	T-40	110
410+5445	T-45	110
440+5450	T-50	110
442+5455	T-55	110

1/2" Dr. Bit Sockets

Metric Wobble Bit Sockets



ITEM NO.	Size mm	Length mm
408+4335	5	80
408+4336	6	80
410+4347	7	80
410+4348	8	80
439+4349	9	80
440+4350	10	80

SAE Wobble Bit Sockets



ITEM NO.	Size Inch	Length mm
408+5312	3/16	80
408+5314	7/32	80
408+5316	1/4	80
410+5318	9/32	80
410+5320	5/16	80
412+5324	3/8	80

408+4535	5	110
408+4536	6	110
410+4547	7	110
410+4548	8	110
439+4549	9	110
440+4550	10	110

408+5512	3/16	110
408+5514	7/32	110
408+5516	1/4	110
410+5518	9/32	110
410+5520	5/16	110
412+5524	3/8	110

Ribe Bit Sockets



ITEM NO.	Size	Length mm
408+9004	M4	55
408+9005	M5	55
408+9006	M6	55
410+9007	M7	55
410+9008	M8	55
440+9009	M9	55
440+9010	M10	55
442+9012	M12	55
444+9013	M13	55
444+9014	M14	55
446+9016	M16	55

ITEM NO.	Size	Length mm
408+9404	M4	110
408+9405	M5	110
408+9406	M6	110
410+9407	M7	110
410+9408	M8	110
440+9409	M9	110
440+9410	M10	110
442+9412	M12	110
444+9413	M13	110
444+9414	M14	110
446+9416	M16	110

408+9204	M4	80
408+9205	M5	80
408+9206	M6	80
410+9207	M7	80
410+9208	M8	80
440+9209	M9	80
440+9210	M10	80
442+9212	M12	80
444+9213	M13	80
444+9214	M14	80
446+9216	M16	80

1/2" Dr. Bit Sockets are also available in 150mmL, 190mmL & 230mmL. Please contact us for more details.

1/2" Dr. Bit Socket Sets

BS-409H 9pcs Metric Hex Bit Socket Set

9 1/2" Dr. Hex (408+2334 ~ -2357)
4 - 5 - 6 - 7 - 8 - 10 - 12 - 14 - 17mm (80mmL)

1170g 20 Sets / 24.5 Kgs / 1.50 CUFT

BS-409T 9pcs Star Bit Socket Set

9 1/2" Dr. Star (408+6320 ~ -6360)
20 - 25 - 27 - 30 - 40 - 45 - 50 - 55 - 60 (80mmL)

930g 20 Sets / 19.5 Kgs / 1.50 CUFT

1/2" Dr. Bit Socket Sets

BS-407P 7pcs Slotted & Philips Bit Socket Set

4 1/2" Dr. Slotted (408+1170 ~ -1292)
7 - 8 - 9 mm (55mmL)
12mm (60mmL)

3 1/2" Dr. Philips (408+1102 ~ -1124)
2 - 3 - 4 (55mmL)

570g 20 Sets / 12.5 Kgs / 0.71 CUFT

BS-408H 8pcs Metric Hex Bit Socket Set

8 1/2" Dr. Hex (408+2134 ~ -2152)
4 - 5 - 6 - 7 - 8 - 9 - 10 - 12mm (55mmL)

630g 20 Sets / 13.5 Kgs / 0.71 CUFT

BS-409L 9pcs Metric Hex Bit Socket Set

9 1/2" Dr. Hex (408+2134 ~ -2150)
4 - 5 - 6 - 8 - 10mm (55mmL)
1/2" Dr. Hex (408+2535 ~ -2548)
5 - 6 - 8mm (110mmL)
1/2" Dr. Hex (440+2650)
10mm (150mmL)

900g 10 Sets / 10 Kgs / 0.77 CUFT

BS-408T 8pcs Star Bit Socket Set

8 1/2" Dr. Star (408+6120 ~ -6255)
20 - 25 - 27 - 30 - 40 - 45 - 50 - 55 (55mmL)

630g 20 Sets / 13.5 Kgs / 0.71 CUFT

BS-410TA 10pcs Tamperproof Star Bit Socket Set

10 1/2" Dr. Tamperproof Star (408+7120 ~ -7170)
T20 - 25 - 27 - 30 - 40 - 45 - 50 - 55 (55mmL)
T60 - 70 (60mmL)

880g 15 Sets / 14.5 Kgs / 0.95 CUFT

BS-410TB 10pcs Tamperproof Star Bit Socket Set

10 1/2" Dr. Tamperproof Star (408+7520 ~ -7570)
T20 - 25 - 27 - 30 - 40 - 45 - 50 - 55 - 60 - 70 (110mmL)

1220g 12 Sets / 16 Kgs / 0.69 CUFT

BS-410TC 10pcs Tamperproof Star Bit Socket Set

10 1/2" Dr. Tamperproof Star (408+7620 ~ -7670)
T20 - 25 - 27 - 30 - 40 - 45 - 50 - 55 - 60 - 70 (150mmL)

1410g 10 Sets / 15 Kgs / 0.77 CUFT

BS-410M 10pcs Triple Square Bit Socket Set

10 1/2" Dr. Triple Square (408+8105 ~ -8114)
M5 - 6 - 8 - 10 - 12 - 14 (55mmL)
1/2" Dr. Triple Square (408+8506 ~ -8512)
M6 - 8 - 10 - 12 (110mmL)

1130g 12 Sets / 14.5 Kgs / 0.69 CUFT

Screwdriver Bits

Screwdriver Bits



Slotted Screwdriver Bits

ITEM NO.	Size mm	Hex Shank	Length mm
1130	0.5 x 3.0	1/4"	30
1140	0.6 x 4.0	1/4"	30
1150	0.8 x 5.0	1/4"	30
1155	0.8 x 5.5	1/4"	30
1160	1.0 x 6.0	1/4"	30
1165	1.0 x 6.5	1/4"	30
1170	1.2 x 7.0	1/4"	30
1250	0.8 x 5.0	5/16"	30
1255	0.8 x 5.5	5/16"	30
1260	1.0 x 6.0	5/16"	30
1265	1.0 x 6.5	5/16"	30
1280	1.2 x 8.0	5/16"	30
1290	1.6 x 9.0	5/16"	30

1530	0.5 x 3.0	1/4"	88
1540	0.6 x 4.0	1/4"	88
1550	0.8 x 5.0	1/4"	88
1560	1.0 x 6.0	1/4"	88
1580	1.2 x 8.0	5/16"	88
1590	1.6 x 9.0	5/16"	88
1592	2.0 x 12.0	10mm	88
1594	2.5 x 14.0	12mm	88
1596	2.5 x 16.0	14mm	88



Spanner Screwdriver Bits

ITEM NO.	Size	Hex Shank	Length mm
9054	SP4	1/4"	30
9056	SP6	1/4"	30
9058	SP8	1/4"	30
9060	SP10	1/4"	30
9062	SP12	1/4"	30
9064	SP14	1/4"	30



Metric Wobble Screwdriver Bits

ITEM NO.	Size mm	Hex Shank	Length mm
4133	3	1/4"	30
4134	4	1/4"	30
4135	5	1/4"	30
4136	6	1/4"	30
4147	7	5/16"	30
4148	8	5/16"	30
4149	9	9mm	30
4150	10	10mm	30

4533	3	1/4"	88
4534	4	1/4"	88
4535	5	1/4"	88
4536	6	1/4"	88
4547	7	5/16"	88
4548	8	5/16"	88
4549	9	9mm	88
4550	10	10mm	88



Philips Screwdriver Bits

ITEM NO.	Size	Hex Shank	Length mm
1100	#0	1/4"	30
1101	#1	1/4"	30
1102	#2	1/4"	30
1103	#3	1/4"	30
1121	#1	5/16"	30
1122	#2	5/16"	30
1123	#3	5/16"	30
1124	#4	5/16"	30

1501	#1	1/4"	88
1502	#2	1/4"	88
1503	#3	1/4"	88
1504	#4	5/16"	88



Posidriv Screwdriver Bits

ITEM NO.	Size	Hex Shank	Length mm
1210	#0	1/4"	30
1211	#1	1/4"	30
1212	#2	1/4"	30
1213	#3	1/4"	30
1221	#1	5/16"	30
1222	#2	5/16"	30
1223	#3	5/16"	30
1224	#4	5/16"	30

1511	#1	1/4"	88
1512	#2	1/4"	88
1513	#3	1/4"	88
1524	#4	5/16"	88



SAE Wobble Screwdriver Bits

ITEM NO.	Size Inch	Hex Shank	Length mm
5108	1/8	1/4"	30
5110	5/32	1/4"	30
5112	3/16	1/4"	30
5114	7/32	1/4"	30
5116	1/4	1/4"	30
5118	9/32	5/16"	30
5120	5/16	5/16"	30
5124	3/8	3/8"	30

5508	1/8	1/4"	88
5510	5/32	1/4"	88
5512	3/16	1/4"	88
5514	7/32	1/4"	88
5516	1/4	1/4"	88
5518	9/32	5/16"	88
5520	5/16	5/16"	88
5524	3/8	3/8"	88

Screwdriver Bits



Metric Hex Screwdriver Bits

ITEM NO.	Size mm	Hex Shank	Length mm
2122	2	1/4"	30
2125	2.5	1/4"	30
2133	3	1/4"	30
2134	4	1/4"	30
2135	5	1/4"	30
2136	6	1/4"	30
2143	3	5/16"	30
2144	4	5/16"	30
2145	5	5/16"	30
2146	6	5/16"	30
2147	7	5/16"	30
2148	8	5/16"	30
2149	9	9mm	30
2150	10	10mm	30
2151	11	11mm	30
2152	12	12mm	30

2522	2	1/4"	88
2525	2.5	1/4"	88
2533	3	1/4"	88
2534	4	1/4"	88
2535	5	1/4"	88
2536	6	1/4"	88
2547	7	5/16"	88
2548	8	5/16"	88
2549	9	9mm	88
2550	10	10mm	88
2551	11	11mm	88
2552	12	12mm	88
2553	13	13mm	88
2554	14	14mm	88
2556	16	16mm	88
2557	17	17mm	88
2559	19	19mm	88



SAE Hex Screwdriver Bits

ITEM NO.	Size Inch	Hex Shank	Length mm
3104	1/16	1/4"	30
3105	5/64	1/4"	30
3106	3/32	1/4"	30
3107	7/64	1/4"	30
3108	1/8	1/4"	30
3110	5/32	1/4"	30
3112	3/16	1/4"	30
3114	7/32	1/4"	30
3116	1/4	1/4"	30
3118	1/8	5/16"	30
3120	5/32	5/16"	30
3122	3/16	5/16"	30
3124	7/32	5/16"	30
3126	1/4	5/16"	30
3128	9/32	5/16"	30
3130	5/16	5/16"	30
3134	3/8	3/8"	30
3138	7/16	7/16"	30
3142	1/2	1/2"	30

3504	1/16	1/4"	88
3505	5/64	1/4"	88
3506	3/32	1/4"	88
3507	7/64	1/4"	88
3508	1/8	1/4"	88
3510	5/32	1/4"	88
3512	3/16	1/4"	88
3514	7/32	1/4"	88
3516	1/4	1/4"	88
3518	9/32	5/16"	88
3520	5/16	5/16"	88
3524	3/8	3/8"	88
3528	7/16	7/16"	88
3532	1/2	1/2"	88
3536	9/16	9/16"	88
3540	5/8	5/8"	88
3544	11/16	11/16"	88
3548	3/4	3/4"	88



Triple Square Screwdriver Bits

ITEM NO.	Size	Hex Shank	Length mm
8104	M4	1/4"	30
8105	M5	1/4"	30
8106	M6	1/4"	30
8108	M8	5/16"	30
8110	M10	10mm	30
8112	M12	12mm	30
8114	M14	14mm	30
8116	M16	16mm	30
8118	M18	19mm	30

8504	M4	1/4"	88
8505	M5	1/4"	88
8506	M6	1/4"	88
8508	M8	5/16"	88
8510	M10	10mm	88
8512	M12	12mm	88
8514	M14	14mm	88
8516	M16	16mm	88
8518	M18	19mm	88



Square Screwdriver Bits

ITEM NO.	Size	Hex Shank	Length mm
9100	S# 0	1/4"	30
9101	S# 1	1/4"	30
9102	S# 2	1/4"	30
9103	S# 3	1/4"	30
9104	S# 4	1/4"	30

9500	S# 0	1/4"	88
9501	S# 1	1/4"	88
9502	S# 2	1/4"	88
9503	S# 3	1/4"	88
9504	S# 4	1/4"	88

The length of screwdriver bits are also available in 125mmL, 160mmL & 200mmL. Please contact us for more details.

Screwdriver Bits

Star Screwdriver Bits

ITEM NO.	Size	Hex Shank	Length mm
6106	T-6	1/4"	30
6107	T-7	1/4"	30
6108	T-8	1/4"	30
6109	T-9	1/4"	30
6110	T-10	1/4"	30
6115	T-15	1/4"	30
6120	T-20	1/4"	30
6125	T-25	1/4"	30
6127	T-27	1/4"	30
6130	T-30	1/4"	30
6140	T-40	1/4"	30
6210	T-10	5/16"	30
6215	T-15	5/16"	30
6220	T-20	5/16"	30
6225	T-25	5/16"	30
6227	T-27	5/16"	30
6230	T-30	5/16"	30
6240	T-40	5/16"	30
6245	T-45	5/16"	30
6250	T-50	5/16"	30
6255	T-55	10mm	30

6506	T-6	1/4"	88
6507	T-7	1/4"	88
6508	T-8	1/4"	88
6509	T-9	1/4"	88
6510	T-10	1/4"	88
6515	T-15	1/4"	88
6520	T-20	1/4"	88
6525	T-25	1/4"	88
6527	T-27	1/4"	88
6530	T-30	1/4"	88
6540	T-40	1/4"	88
6545	T-45	5/16"	88
6550	T-50	5/16"	88
6555	T-55	10mm	88
6560	T-60	12mm	88
6570	T-70	14mm	88

Pentacle Screwdriver Bits

ITEM NO.	Size	Hex Shank	Length mm
5008	T-8	1/4"	30
5010	T-10	1/4"	30
5015	T-15	1/4"	30
5020	T-20	1/4"	30
5025	T-25	1/4"	30
5027	T-27	1/4"	30
5030	T-30	1/4"	30
5040	T-40	5/16"	30
5045	T-45	5/16"	30
5050	T-50	10mm	30
5055	T-55	12mm	30

5408	T-8	1/4"	88
5410	T-10	1/4"	88
5415	T-15	1/4"	88
5420	T-20	1/4"	88
5425	T-25	1/4"	88
5427	T-27	1/4"	88
5430	T-30	1/4"	88
5440	T-40	5/16"	88
5445	T-45	5/16"	88
5450	T-50	10mm	88
5455	T-55	12mm	88

Tamperproof Star Screwdriver Bits

ITEM NO.	Size	Hex Shank	Length mm
7107	T-7	1/4"	30
7108	T-8	1/4"	30
7109	T-9	1/4"	30
7110	T-10	1/4"	30
7115	T-15	1/4"	30
7120	T-20	1/4"	30
7125	T-25	1/4"	30
7127	T-27	1/4"	30
7130	T-30	1/4"	30
7140	T-40	1/4"	30
7145	T-45	5/16"	30
7150	T-50	5/16"	30
7155	T-55	10mm	30

7507	T-7	1/4"	88
7508	T-8	1/4"	88
7509	T-9	1/4"	88
7510	T-10	1/4"	88
7515	T-15	1/4"	88
7520	T-20	1/4"	88
7525	T-25	1/4"	88
7527	T-27	1/4"	88
7530	T-30	1/4"	88
7540	T-40	1/4"	88
7545	T-45	5/16"	88
7550	T-50	5/16"	88
7555	T-55	10mm	88
7560	T-60	12mm	88
7570	T-70	14mm	88

Ribe Screwdriver Bits

ITEM NO.	Size	Hex Shank	Length mm
9004	M4	1/4"	30
9005	M5	1/4"	30
9006	M6	1/4"	30
9007	M7	5/16"	30
9008	M8	5/16"	30
9009	M9	10mm	30
9010	M10	10mm	30
9012	M12	12mm	30
9013	M13	14mm	30
9014	M14	14mm	30
9016	M16	16mm	30

9404	M4	1/4"	88
9405	M5	1/4"	88
9406	M6	1/4"	88
9407	M7	5/16"	88
9408	M8	5/16"	88
9409	M9	10mm	88
9410	M10	10mm	88
9412	M12	12mm	88
9413	M13	14mm	88
9414	M14	14mm	88
9416	M16	16mm	88

Power Bits

Slotted Power Bits

ITEM NO.	Size mm	Hex Shank	Length mm
205030	0.5X3.0	1/4"	50
205040	0.6X4.0	1/4"	50
205050	0.8X5.0	1/4"	50
205055	0.8X5.5	1/4"	50
205060	1.0X6.0	1/4"	50
205065	1.0X6.5	1/4"	50
205070	1.2X7.0	1/4"	50

Slotted Bits

ITEM NO.	Size mm	Hex Shank	Length mm
217250	0.8X5.0	5/16"	72
217255	0.8X5.5	5/16"	72
217260	1.0X6.0	5/16"	72
217265	1.0X6.5	5/16"	72
217270	1.2X8.0	5/16"	72
217280	1.6X9.0	5/16"	72

Philips Power Bits

ITEM NO.	Size	Hex Shank	Length mm
235000	#0	1/4"	50
235001	#1	1/4"	50
235002	#2	1/4"	50
235003	#3	1/4"	50

Philips Bits

ITEM NO.	Size	Hex Shank	Length mm
247201	#1	5/16"	72
247202	#2	5/16"	72
247203	#3	5/16"	72
247204	#4	5/16"	72

Posidriv Power Bits

ITEM NO.	Size	Hex Shank	Length mm
255001	#1	1/4"	50
255002	#2	1/4"	50
255003	#3	1/4"	50

Posidriv Bits

ITEM NO.	Size	Hex Shank	Length mm
277201	#1	5/16"	72
277202	#2	5/16"	72
277203	#3	5/16"	72
277204	#4	5/16"	72

Metric Hex Power Bits

ITEM NO.	Size mm	Hex Shank	Length mm
265020	2	1/4"	50
265025	2.5	1/4"	50
265030	3	1/4"	50
265040	4	1/4"	50
265050	5	1/4"	50
265060	6	1/4"	50

Metric Hex Bits

ITEM NO.	Size mm	Hex Shank	Length mm
297230	3	5/16"	72
297240	4	5/16"	72
297250	5	5/16"	72
297260	6	5/16"	72
297270	7	5/16"	72
297280	8	5/16"	72

SAE Hex Power Bits

ITEM NO.	Size Inch	Hex Shank	Length mm
275003	3/32	1/4"	50
275004	1/8	1/4"	50
275005	5/32	1/4"	50
275006	3/16	1/4"	50
275007	7/32	1/4"	50
275008	1/4	1/4"	50

SAE Hex Bits

ITEM NO.	Size Inch	Hex Shank	Length mm
297204	1/8	5/16"	72
297205	5/32	5/16"	72
297206	3/16	5/16"	72
297207	7/32	5/16"	72
297208	1/4	5/16"	72
297209	9/32	5/16"	72
297210	5/16	5/16"	72

Star Power Bits

ITEM NO.	Size	Hex Shank	Length mm
285008	T-8	1/4"	50
285010	T-10	1/4"	50
285015	T-15	1/4"	50
285020	T-20	1/4"	50
285025	T-25	1/4"	50
285027	T-27	1/4"	50
285030	T-30	1/4"	50
285040	T-40	1/4"	50

Star Bits

ITEM NO.	Size	Hex Shank	Length mm
227210	T-10	5/16"	72
227215	T-15	5/16"	72
227220	T-20	5/16"	72
227225	T-25	5/16"	72
227227	T-27	5/16"	72
227230	T-30	5/16"	72
227240	T-40	5/16"	72
227245	T-45	5/16"	72
227250	T-50	5/16"	72

Screwdriver Bits

Screwdriver Bit Holders

Bit Holders



ITEM NO.	Drive	Hex Shank	Length mm
208+	1/4"	1/4"	25

308+	3/8"	1/4"	28
310+	3/8"	5/16"	30
312+	3/8"	3/8"	30
314+	3/8"	7/16"	30
316+	3/8"	1/2"	30

339+	3/8"	9mm	30
340+	3/8"	10mm	30
341+	3/8"	11mm	30
342+	3/8"	12mm	30
344+	3/8"	14mm	30

408+	1/2"	1/4"	36
410+	1/2"	5/16"	38
412+	1/2"	3/8"	40
414+	1/2"	7/16"	40
416+	1/2"	1/2"	40
418+	1/2"	9/16"	40
420+	1/2"	5/8"	40
422+	1/2"	11/16"	40
424+	1/2"	3/4"	40

439+	1/2"	9mm	40
440+	1/2"	10mm	40
441+	1/2"	11mm	40
442+	1/2"	12mm	40
443+	1/2"	13mm	40
444+	1/2"	14mm	40
446+	1/2"	16mm	40
447+	1/2"	17mm	40
449+	1/2"	19mm	40

Bit Holders quick change



ITEM NO.	Drive	Hex Shank	Length mm
283508	1/4"	1/4"	35
283510	1/4"	5/16"	35

384608	3/8"	1/4"	46
383908	3/8"	1/4"	39
384610	3/8"	5/16"	46
383910	3/8"	5/16"	39
383912	3/8"	3/8"	39
323910	3/8"	10mm	39

484808	1/2"	1/4"	48
484108	1/2"	1/4"	41
484810	1/2"	5/16"	48
484110	1/2"	5/16"	41
484112	1/2"	3/8"	41
484314	1/2"	7/16"	43
484516	1/2"	1/2"	45
424110	1/2"	10mm	41
424312	1/2"	12mm	43
424514	1/2"	14mm	45

Screwdriver Bit Accessories

T-Handle Ratcheting Screwdrivers



ITEM NO.	Hex Shank	Shank Length mm	Overall Length mm
520+2982	1/4"	22	72
520+2985	1/4"	50	100
520+2988	1/4"	85	135
520+2990	1/4"	200	250
*520+2983	1/4"	22	72

*with quick release chunk

Standard Handle Ratcheting Screwdrivers



ITEM NO.	Hex Shank	Shank Length mm	Overall Length mm
524+2982	1/4"	22	162
524+2985	1/4"	50	190
524+2988	1/4"	85	225
524+2990	1/4"	200	340
*524+2983	1/4"	22	162

*with quick release chunk

Stubby Handle Ratcheting Screwdrivers



ITEM NO.	Hex Shank	Shank Length mm	Overall Length mm
522+2982	1/4"	22	87
522+2985	1/4"	50	115
*522+2983	1/4"	22	87

*with quick release chunk

Pistol Grip Handle Ratcheting Screwdrivers



ITEM NO.	Hex Shank	Shank Length mm	Overall Length mm
526+2985	1/4"	50	215
526+2988	1/4"	85	250
*526+2986	1/4"	50	215

*with quick release chunk

Screwdriver Bit Accessories

OMNIDRIVE® 3in1 Handgrip

ITEM NO.	Hex Shank	Hex Shank	Hex Shank	Length mm
280120	1/4"	1/4"	5/16"	120

Be versatile. The OMNIDRIVE 3-in-1 Handgrip grants users the ability to interchange bits with its 1/4" and 5/16" hex shank drivers while alternating between traditional screwdriver and T-handle style grips.

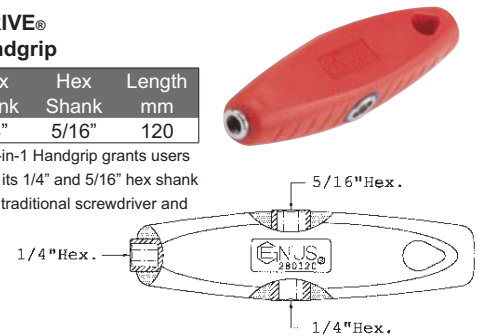

OMNIDRIVE® 4in1 Handgrip

ITEM NO.	Hex Shank	Hex Shank	Square Drive	Square Drive	Length mm
280121	1/4"	1/4"	1/4"	1/4"	120

Be versatile. The OMNIDRIVE 4-in-1 Handgrip grants users the ability to interchange between 1/4" hex shank bits and 1/4" square drive while alternating between traditional screwdriver and T-handle style grips.

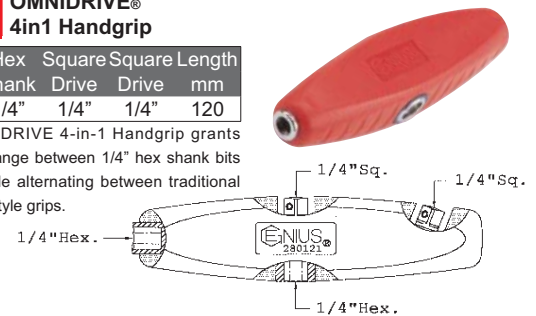

Flexible Extension

ITEM NO.	Male Drive	Female Drive	Length mm
282150	1/4"	1/4"	150

Flexible Bit Holder

ITEM NO.	Hex Shank	Female Drive	Length mm
282165	1/4"	1/4"	165

Flexible Bit Holder

ITEM NO.	Hex Shank	Hex Drive	Length mm
0260	1/4"	1/4"	180

Flexible Bit Holder w/ Handle

ITEM NO.	Hex Shank	Shank Length mm	Overall mm
594+0260	1/4"	125	260

Flexible Extension

ITEM NO.	Square Drive	Hex Drive	Length mm
0250	1/4"	1/4"	170

Flexible Spinner w/ Handle

ITEM NO.	Square Drive	Shank Length mm	Overall mm
594+0250	1/4"	125	250

Magnetic Bit Holder

ITEM NO.	Hex Shank	Hex Drive	Length mm
0230	1/4"	1/4"	150

Magnetic Bit Holder w/ Handle

ITEM NO.	Hex Shank	Shank Length mm	Overall mm
594+0230	1/4"	125	230

Bit Holder with Handle

ITEM NO.	Hex Shank	Length mm
280150	1/4"	150

Magnetic Stubby Bit Holder w/ Handle

ITEM NO.	Hex Shank	Length mm
280060	1/4"	60

Screwdriver Bit Accessories



Magnetic Bit Holder Adapters

ITEM NO.	Hex Shank	Hex Drive	Length mm
*286008	1/4"	1/4"	60
286008M	1/4"	1/4"	60

* direct fitting for electric and pneumatic impact wrenches

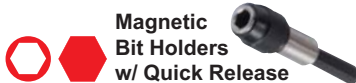

Magnetic Bit Holders w/ Quick Release

ITEM NO.	Hex Shank	Hex Drive	Length mm
*285708	1/4"	1/4"	60
285708M	1/4"	1/4"	60

* direct fitting for electric and pneumatic impact wrenches

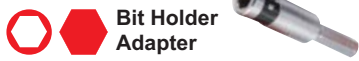

Bit Holder Adapter

ITEM NO.	Hex Shank	Hex Drive	Length mm
285608	1/4"	1/4"	60



Socket Holder Adapter

ITEM NO.	Square Drive	Hex Drive	Length mm
280002B	1/4"	1/4"	30



Spinner Handles

ITEM NO.	Square Drive	Hex Drive	Length mm
272065	1/4"	1/4"	65
272140	1/4"	1/4"	140
273065	3/8"	1/4"	65
274065	1/2"	1/4"	65

Assorted Screwdriver Bit Sets

SB-111SP 11pcs Slotted & Philips Bit Set

- 6 Slotted (1130 ~ 1170) 30mmL
3 - 4 - 5 - 5.5 - 6 - 7mm
- 4 Philips (1100 ~ 1103) 30mmL
#0 - 1 - 2 - 3
- 1 Socket Holder Adapter (280002B)

100g 160 Sets / 17 Kgs / 0.71 CUFT

SB-211MH 11pcs Metric Hex & Triple Square Bit Set

- 8 Hex (2122 ~ 2136)
2 - 2.5 - 3 - 4 - 5 - 6 - 7 - 8mm (30mmL)
- 3 Triple Square (8104 ~ 8106)
M4 - 5 - 6 (30mmL)

100g 160 Sets / 17 Kgs / 0.71 CUFT

SB-311SH 11pcs SAE Hex Bit Set

- 11 Hex (3104 ~ 3116)
1/16 - 5/64 - 3/32 - 7/64 - 1/8 - 5/32 - 3/16 - 7/32 - 1/4 - 9/32 - 5/16" (30mmL)

100g 160 Sets / 17 Kgs / 0.71 CUFT

SB-711TP 11pcs Star Bit Set

- 11 Star (6106 ~ 6140)
T6 - 7 - 8 - 9 - 10 - 15 - 20 - 25 - 27 - 30 - 40 (30mmL)

100g 160 Sets / 17 Kgs / 0.71 CUFT

SB-811TP 11pcs Tamperproof Star Bit Set

- 11 Tamperproof Star (7107 ~ 7140)
T7 - 8 - 9 - 10 - 15 - 20 - 25 - 27 - 30 - 40 - 45 (30mmL)

100g 160 Sets / 17 Kgs / 0.71 CUFT

NEW

Assorted Screwdriver Bit Sets

SC-237M 37pcs Ratcheting Screwdriver & Bit Set

- 6 Slotted: 3 - 4 - 5 - 5.5 - 6 - 7mm (30mmL)
- 3 Phillips: #1 - 2 - 3 (30mmL)
- 3 Posidriv #1 - 2 - 3 (30mmL)
- 6 Hex: 2 - 2.5 - 3 - 4 - 5 - 6mm (30mmL)
- 7 Star: T10 - 15 - 20 - 25 - 27 - 30 - 40 (30mmL)
- 7 Tamperproof Star: T10 - 15 - 20 - 25 - 27 - 30 - 40 (30mmL)
- 3 Triple Square: M4 - 5 - 6 (30mmL)
- 1 Socket Holder Adapter (280002B)
- 1 Ratcheting Screwdriver (524+2988)

650g 20 Sets / 14 Kgs / 1.50 CUFT

SC-234A 34pcs Ratcheting Screwdriver & Bit Set

- 6 Slotted: 4 - 5 - 5.5 - 6 - 6.5 - 7mm (30mmL)
- 3 Phillips: #1 - 2 - 3 (30mmL)
- 6 Hex: 3/32 - 1/8 - 5/32 - 3/16 - 7/32 - 1/4" (30mmL)
- 7 Star: T10 - 15 - 20 - 25 - 27 - 30 - 40 (30mmL)
- 7 Tamperproof Star: T10 - 15 - 20 - 25 - 27 - 30 - 40 (30mmL)
- 3 Square: #1 - 2 - 3 (30mmL)
- 1 Socket Holder Adapter (280002B)
- 1 Ratcheting Screwdriver (524+2988)

700g 20 Sets / 15 Kgs / 1.50 CUFT

SB-252M 52pcs Metric Bits w/ OMNIDRIV® Set

- 1 OMNIDRIVE® 4in1 Handgrip (280121)
- 6 Slotted: 3 - 4 - 5 - 5.5 - 6 - 7mm (30mmL)
- 4 Phillips: #0 - 1 - 2 - 3 (30mmL)
- 8 Hex: 2 - 2.5 - 3 - 4 - 5 - 6 - 7 - 8mm (30mmL)
- 11 Star: T6 - 7 - 8 - 9 - 10 - 15 - 20 - 25 - 27 - 30 - 40 (30mmL)
- 3 Triple Sq.: M4 - 5 - 6 (30mmL)
- 10 1/4" Dr. Socket (222503 ~ 222510)
3 - 4 - 4.5 - 5 - 5.5 - 6 - 7 - 8 - 9 - 10mm
- 9 Accessories: Socket Holder Adapter, Flexible Ext., Flexible Bit Holder, Magnetic Bit Holder 60&150mmL, Stubby Bit Holder, Extension Bar 100mmL, Wobble Ext. 50&150mmL

1270g 12 Sets / 16 Kgs / 1.16 CUFT

SB-276MS 76pcs Metric & SAE Complete Bits w/ OMNIDRIV® Set

- 1 OMNIDRIVE® 4in1 Handgrip (280121)
- 6 Slotted: 3 - 4 - 5 - 5.5 - 6 - 7mm (30mmL)
- 4 Phillips: #0 - 1 - 2 - 3 (30mmL)
- 19 Hex: 2 - 2.5 - 3 - 4 - 5 - 6 - 7 - 8mm (30mmL)
Hex: 1/16 - 5/64 - 3/32 - 7/64 - 1/8 - 5/32 - 3/16 - 7/32 - 1/4 - 9/32 - 5/16" (30mmL)
- 11 Star: T6 - 7 - 8 - 9 - 10 - 15 - 20 - 25 - 27 - 30 - 40 (30mmL)
- 3 Triple Sq.: M4 - 5 - 6 (30mmL)
- 5 Sq.: #0 - 1 - 2 - 3 - 4 (30mmL)
- 18 1/4" Dr. Socket (222503 ~ 222510)
3 - 4 - 4.5 - 5 - 5.5 - 6 - 7 - 8 - 9 - 10mm
1/4" Dr. Socket (282504 ~ 282512)
1/8 - 3/16 - 7/32 - 1/4 - 9/32 - 5/16 - 11/32 - 3/8"
- 9 Accessories: Socket Holder Adapter, Flexible Ext., Flexible Bit Holder, Magnetic Bit Holder 60&150mmL, Stubby Bit Holder, Extension Bar 100mmL, Wobble Ext. 50&150mmL

1500g 12 Sets / 19 Kgs / 1.16 CUFT

Screwdriver Bits

Assorted Screwdriver Bit Sets

TX-246M 46pcs Metric Extra Long Complete Bits w/ OMNIDRIV® Set

- 1 OMNIDRIVE® 3in1 Handgrip (280120)
- 4 Slotted: 4 - 5 - 6 - 8mm (160mmL)
- 4 Philips: #1 - 2 - 3 - 4 (160mmL)
- 7 Hex: 2.5 - 3 - 4 - 5 - 6 - 7 - 8mm (160mmL)
- 13 Star: T6 - 7 - 8 - 9 - 10 - 15 - 20 - 25 - 27 - 30 - 40 - 45 - 50 (160mmL)
- 4 Triple Sq.: M4 - 5 - 6 - 8 (160mmL)
- 10 1/4" Dr. Socket (222504 ~ 222513) 4 - 5 - 6 - 7 - 8 - 9 - 10 - 11 - 12 - 13mm
- 3 1/4" Dr. Spinner Handle 65&140mmL - Universal Joint

2460g 4 Sets / 11 Kgs / 1.07 CUFT

TX-246S 46pcs SAE Extra Long Complete Bits w/ OMNIDRIV® Set

- 1 OMNIDRIVE® 3in1 Handgrip (280120)
- 4 Slotted: 4 - 5 - 6 - 8mm (160mmL)
- 4 Philips: #1 - 2 - 3 - 4 (160mmL)
- 7 Hex (3708 ~ 3720) 160mmL 1/8 - 5/32 - 3/16 - 7/32 - 1/4 - 9/32 - 5/16"
- 13 Star: T6 - 7 - 8 - 9 - 10 - 15 - 20 - 25 - 27 - 30 - 40 - 45 - 50 (160mmL)
- 4 Triple Sq.: M4 - 5 - 6 - 8 (160mmL)
- 10 1/4" Dr. Socket (282504 ~ 282516) 1/8 - 3/16 - 7/32 - 1/4 - 9/32 - 5/16 - 11/32 - 3/8 - 7/16 - 1/2"
- 3 1/4" Dr. Spinner Handle 65&140mmL - Universal Joint

2460g 4 Sets / 11 Kgs / 1.07 CUFT

TX-23475M 75pcs Metric Complete Bit Set

- 26 Hex: 2 - 2.5 - 3 - 4 - 5 - 6 - 7 - 8 - 9 - 10 - 11 - 12mm (30mmL)
- Hex: 2 - 2.5 - 3 - 4 - 5 - 6 - 7 - 8 - 9 - 10 - 11 - 12 - 13 - 14mm (88mmL)
- 14 Star: T6 - 7 - 8 - 9 - 10 - 15 - 20 - 25 - 27 - 30 - 40 - 45 - 50 - 55 (30mmL)
- 16 Tamperproof Star: T7 - 8 - 9 - 10 - 15 - 20 - 25 - 27 - 30 - 40 - 45 - 50 - 55 - 60 - 70 (88mmL)
- 14 Triple Square: M4 - 5 - 6 - 8 - 10 - 12 - 14 (30mmL)
- Triple Square: M4 - 5 - 6 - 8 - 10 - 12 - 14 (88mmL)
- 6 Bit Holders 1/4"Dr. x 1/4"Hex Shank - 3/8"Dr. x 5/16"Hex Shank - 1/2"Dr. x 5/16", 10mm, 12mm, 14mm Hex Shank

3200g 4 Sets / 14 Kgs / 1.07 CUFT

TX-23478S 78pcs SAE Complete Bit Set

- 26 Hex: 3/32 - 7/64 - 1/8 - 5/32 - 3/16 - 7/32 - 1/4 - 9/32 - 5/16 - 3/8 - 7/16 - 1/2" (30mmL)
- Hex: 1/16 - 5/64 - 3/32 - 7/64 - 1/8 - 5/32 - 3/16 - 7/32 - 1/4 - 9/32 - 5/16 - 3/8 - 7/16 - 1/2" (88mmL)
- 14 Star: T6 - 7 - 8 - 9 - 10 - 15 - 20 - 25 - 27 - 30 - 40 - 45 - 50 - 55 (30mmL)
- 16 Star: T7 - 8 - 9 - 10 - 15 - 20 - 25 - 27 - 30 - 40 - 45 - 50 - 55 - 60 - 70 (88mmL)
- 14 Triple Square: M4 - 5 - 6 - 8 - 10 - 12 - 14 (30mmL)
- Triple Square: M4 - 5 - 6 - 8 - 10 - 12 - 14 (88mmL)
- 9 Bit Holders 1/4"Dr. x 1/4"Hex Shank - 3/8"Dr. x 5/16"Hex Shank - 1/2"Dr. x 5/16", 3/8", 7/16", 1/2", 10mm, 12mm, 14mm Hex Shank

3400g 4 Sets / 15 Kgs / 1.07 CUFT

Screwdriver Bit Accessory Sets

GA-015A 15pcs 1/4" Hex Shank Ratcheting Screwdriver Accessory

- 2 Spinner Handle: 65 - 140mmL
- 1 Hex Adapter: 50mmL
- 3 Extensions: 88 - 160 - 250mmL
- 2 Magnetic Bit Holder: 150 - 250mmL
- 1 Magnetic Bit Holder: 60mmL
- 1 Flexible Bit Holder: 300mmL
- 1 Flexible Extension: 170mmL
- 1 Flexible Extension: 300mmL
- 1 Stubby Bit Holder: 60mmL
- 1 Ratcheting Screwdriver: 162mmL
- 1 T-Ratcheting Screwdriver: 72mmL

1600g 5 Sets / 9 Kgs / 1.01 CUFT

1/4" Hex Shank Reversible Blades

ITEM NO.	Size mm	Pattern A	Pattern B	Length mm
502046	0.8x4.0 - 1.2x6.5	⊕	⊖	180
502057	1.0x5.5 - 1.5x7.0	⊕	⊖	180
502114	PH.1 - 0.6x4.0	⊕	⊖	180
502126	PH.2 - 1.0x6.0	⊕	⊖	180
502137	PH.3 - 1.2x7.0	⊕	⊖	180
502201	PH.0 - PH.1	⊕	⊖	180
502212	PH.1 - PH.2	⊕	⊖	180
502223	PH.2 - PH.3	⊕	⊖	180
502311	PH.1 - PZ.1	⊕	⊖	180
502322	PH.2 - PZ.2	⊕	⊖	180
502401	PZ.0 - PZ.1	⊕	⊖	180
502412	PZ.1 - PZ.2	⊕	⊖	180
502423	PZ.2 - PZ.3	⊕	⊖	180
502515	T10 - T15	⊕	⊖	180
502525	T20 - T25	⊕	⊖	180
502540	T30 - T40	⊕	⊖	180
502625	2.5 - 2.5	⊕	⊖	180
502630	3.0 - 3.0	⊕	⊖	180
502640	4.0 - 4.0	⊕	⊖	180
502650	5.0 - 5.0	⊕	⊖	180
502660	6.0 - 6.0	⊕	⊖	180

RB-207W 7pcs Combination Reversible Blades Set

- 2 Philips / Slotted: #1 - 0.6x4.0mm (180mmL) #2 - 1.0x6.0mm (180mmL)
- 1 Posidriv: #1 - #2 (180mmL)
- 3 Star: T10 - T15, T20 - T25 T30 - T40 (180mmL)
- 1 1/4" Shank Grip Handle 110mmL

560g 20 Sets / 12.5 Kgs / 1.50 CUFT

RB-211W 11pcs Combination Reversible Blades Set

- 2 Slotted: 4.0 - 6.5mm, 5.5 - 7.0mm (180mmL)
- 1 Philips: #1 - #2 (180mmL)
- 1 Posidriv: #1 - #2 (180mmL)
- 3 Hex / Wobble: 4 - 4, 5 - 5, 6 - 6mm (180mmL)
- 3 Star: T10 - T15, T20 - T25 T30 - T40 (180mmL)
- 1 1/4" Shank Grip Handle 110mmL

840g 12 Sets / 11 Kgs / 1.16 CUFT

Impact Drivers & Sets

Impact Drivers

ITEM NO.	Drive	Length mm
700007	3/8"	135
700008	1/2"	138



ID-314 14pcs 3/8" Dr. Impact Driver Set

- 6 5/16" Hex Shank Slotted: 6.5 - 8.0 - 9.0mm (30mmL) 7.0 - 8.0 - 9.0mm (56mmL)
- 6 5/16" Hex Shank Philips: #2 - 3 - 4 (30mmL) #2 - 3 - 4 (56mmL)
- 1 3/8" Dr. 5/16" Hex Bit Holder
- 1 3/8" Dr. Impact Driver



1260g 15 Sets / 20 Kgs / 0.95 CUFT

TG-406B 6pcs 1/2" Dr. Impact Driver Set

- 2 5/16" Hex Shank Slotted: 1.2x8.0 - 1.6x10.0mm
- 2 5/16" Hex Shank Philips: #2 - 3
- 1 1/2" Dr. 5/16" Hex Bit Holder
- 1 1/2" Dr. Impact Driver



1020g 20 Sets / 22.5 Kgs / 0.64 CUFT

ID-414 14pcs 1/2" Dr. Impact Driver Set

- 6 5/16" Hex Shank Slotted: 6.5 - 8.0 - 9.0mm (30mmL) 7.0 - 8.0 - 9.0mm (56mmL)
- 6 5/16" Hex Shank Philips: #2 - 3 - 4 (30mmL) #2 - 3 - 4 (56mmL)
- 1 1/2" Dr. 5/16" Hex Bit Holder
- 1 1/2" Dr. Impact Driver



1260g 15 Sets / 20 Kgs / 0.95 CUFT

Torque Screwdrivers & Sets

Torque Screwdrivers

ITEM NO.	Drive	Capacity	Length mm
280005N	1/4"	0.5 ~ 5 Nm	150
280045L	1/4"	8 ~ 45 in.lbs.	150



TO-227N 27pcs Nm Torque Screwdriver Set

- 3 Slotted: 6 - 6.5 - 7mm (30mmL)
- 4 Hex: 3 - 4 - 5 - 6mm (30mmL)
- 7 Tamperproof Star: T10 - 15 - 20 - 25 - 27 - 30 - 40 (30mmL)
- 3 Philips: #1 - 2 - 3 (30mmL)
- 5 SAE Hex: 1/8 - 5/32 - 3/16 - 7/32 - 1/4" (30mmL)
- 3 Triple Square: M4 - 5 - 6 (30mmL)
- 1 1/4" Dr. 1/4" Hex Shank Bit Holder
- 1 1/4" Dr. Torque Screwdriver 0.5 ~ 5 Nm

750g 15 Sets / 12.5 Kgs / 0.95 CUFT

TO-227L 27pcs in.lbs. Torque Screwdriver Set

- 3 Slotted: 6 - 6.5 - 7mm (30mmL)
- 4 Hex: 3 - 4 - 5 - 6mm (30mmL)
- 7 Tamperproof Star: T10 - 15 - 20 - 25 - 27 - 30 - 40 (30mmL)
- 3 Philips: #1 - 2 - 3 (30mmL)
- 5 SAE Hex: 1/8 - 5/32 - 3/16 - 7/32 - 1/4" (30mmL)
- 3 Triple Square: M4 - 5 - 6 (30mmL)
- 1 1/4" Dr. 1/4" Hex Shank Bit Holder
- 1 1/4" Dr. Torque Screwdriver 8 ~ 45 in.lbs.

750g 15 Sets / 12.5 Kgs / 0.95 CUFT

TO-227N
(TO-227L)



Offset Screwdrivers

Offset Screwdrivers

ITEM NO.	Size	Length mm
560610	1.0 x 6	125
560812	1.2 x 8	150
560916	1.6 x 9	175
570012	#1 - 2	125
570034	#3 - 4	175



OS-505SP 5pcs Offset Screwdriver Set

- 3 Slotted Offset Screwdriver 6 - 8 - 9mm
- 2 Phillips Offset Screwdriver #1 x #2 - #1 x #2



370g 40 Sets / 16 Kgs / 0.71 CUFT

Tang-Thru Screwdrivers

Slotted Tang-Thru Screwdrivers

ITEM NO.	Size mm	Shank Length mm	Overall Length mm
509+1966	1.2x6.5	125	245
509+1990	1.6x10.0	185	305
509+1992	2.0x12.0	195	315
509+1994	2.5x14.0	245	365

Phillips Tang-Thru Screwdrivers

ITEM NO.	Size	Shank Length mm	Overall Length mm
509+1801	#1	100	220
509+1812	#2	125	245
509+1843	#3	135	255
509+1924	#4	185	305

Posidriv Tang-Thru Screwdrivers

ITEM NO.	Size	Shank Length mm	Overall Length mm
509+1951	#1	100	220
509+1952	#2	125	245
509+1943	#3	160	270
509+1974	#4	210	320

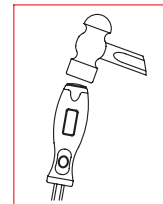

TT-508SP 8pcs Slotted & Phillips Tang-Thru Screwdriver Set

- 4 Slotted: 6.5x245 - 10.0x305 - 12.0x315 - 14.0x365mmL
- 4 Phillips: #1x200 - #2x245 - #3x255 - #4x305mmL



2840g 4 Sets / 12.5 Kgs / 1.07 CUFT

TT-512PZ 12pcs Combination Tang-Thru Screwdriver Set

- 4 Slotted: 6.5x245 - 10.0x305 - 12.0x315 - 14.0x365mmL
- 4 Phillips: #1x220 - #2x245 - #3x255 - #4x305mmL
- 4 Posidriv: #1x220 - #2x245 - #3x270 - #4x320mmL



3750g 4 Sets / 16 Kgs / 1.65 CUFT

Screwdrivers

Screwdrivers w/ Rubber Handle

Slotted Screwdrivers

ITEM NO.	Size mm	Shank Length mm	Overall Length mm	Shank Type
504+0430	0.5x3.0	75	155	D
504+1240	0.8x4.0	100	180	H
504+0550	0.8x5.0	250	330	D
506+1455	1.0x5.5	100	200	H
506+0560	1.0x6.0	150	250	D
506+1965	1.2x6.5	100	200	H
506+1966	1.2x6.5	150	250	H
506+0680	1.2x8.0	200	300	D
506+1980	1.2x8.0	180	280	H
508+1990	1.6x10.0	200	320	H
508+0890	1.6x10.0	250	370	D
508+1992	2.0x12.0	200	320	H
508+1994	2.5x14.0	250	370	H
502+1465	1.2x6.5	38	98	H

"D" for round shank, "H" for hex shank



Philips Screwdrivers

ITEM NO.	Size	Shank Length mm	Overall Length mm	Shank Type
504+0400	#0	75	155	D
504+1401	#1	90	170	H
504+1421	#1	120	200	H
504+0531	#1	250	330	D
506+0602	#2	75	175	D
506+1712	#2	100	200	H
506+1802	#2	125	225	H
506+0612	#2	150	250	D
506+1902	#2	200	300	H
506+0632	#2	300	400	D
508+1913	#3	125	245	H
508+1843	#3	150	270	H
508+1923	#3	200	320	H
508+0833	#3	270	390	D
508+1924	#4	200	320	H
502+1201	#1	38	98	H
502+1202	#2	38	98	H

"D" for round shank, "H" for hex shank



Posidriv Screwdrivers

ITEM NO.	Size mm	Shank Length mm	Overall Length mm	Shank Type
504+0450	#0	75	155	D
504+1741	#1	75	155	H
504+1841	#1	100	180	H
504+1951	#1	125	205	H
504+0561	#1	150	230	D
504+1971	#1	250	330	H
506+1842	#2	100	200	H
506+1952	#2	150	250	H
506+0662	#2	200	300	D
506+1972	#2	300	400	H
508+1943	#3	175	295	H
508+1974	#4	220	340	H
502+0501	#1	38	98	D
502+0502	#2	38	98	D

"D" for round shank, "H" for hex shank



Screwdrivers w/ Rubber Handle

Star Screwdrivers

ITEM NO.	Size	Shank Length mm	Overall Length mm
504+6606	T6	70	150
504+6607	T7	70	150
504+6608	T8	70	150
504+6609	T9	70	150
506+6710	T10	85	185
506+6715	T15	85	185
506+6720	T20	85	185
506+6725	T25	85	185
506+6827	T27	125	225
506+6830	T30	125	225
508+6840	T40	115	235
508+6845	T45	115	235
508+6850	T50	115	235

Tamperproof Star Screwdrivers

ITEM NO.	Size	Shank Length mm	Overall Length mm
504+7606	T6	70	150
504+7607	T7	70	150
504+7608	T8	70	150
504+7609	T9	70	150
506+7710	T10	80	180
506+7715	T15	80	180
506+7920	T20	100	200
506+7925	T25	100	200
506+7827	T27	125	225
506+7830	T30	125	225
508+7940	T40	135	255
508+7945	T45	135	255
508+7850	T50	115	235

Metric Hex Screwdrivers

ITEM NO.	Size mm	Shank Length mm	Overall Length mm
504+2622	2	70	150
504+2625	2.5	70	150
504+2633	3	70	150
506+2634	4	70	170
506+2735	5	85	185
506+2736	6	85	185
508+2847	7	115	235
508+2848	8	115	235
508+2849	9	115	235
508+2850	10	115	235

SAE Hex Screwdrivers

ITEM NO.	Size Inch	Shank Length mm	Overall Length mm
504+3604	1/16	70	150
504+3605	5/64	70	150
504+3606	3/32	70	150
504+3607	7/64	70	150
504+3608	1/8	70	150
506+3610	5/32	70	170
506+3712	3/16	85	185
506+3714	7/32	85	185
506+3816	1/4	125	225
508+3818	9/32	115	235
508+3820	5/16	115	235
508+3824	3/8	115	235

Metric Wobble Hex Screwdrivers

ITEM NO.	Size mm	Shank Length mm	Overall Length mm
504+4633	3	70	150
506+4634	4	70	170
506+4735	5	85	185
506+4736	6	85	185
508+4847	7	115	235
508+4848	8	115	235
508+4849	9	115	235
508+4850	10	115	235

SAE Wobble Hex Screwdrivers

ITEM NO.	Size Inch	Shank Length mm	Overall Length mm
504+5608	1/8	70	150
506+5610	5/32	70	170
506+5712	3/16	85	185
506+5714	7/32	85	185
506+5816	1/4	125	225
508+5818	9/32	115	235
508+5820	5/16	115	235
508+5824	3/8	115	235

Square Screwdrivers

ITEM NO.	Size	Shank Length mm	Overall Length mm
506+9800	#0	125	225
506+9801	#1	125	225
508+9802	#2	125	245
508+9803	#3	125	245
508+9804	#4	125	245

Screwdriver Sets w/ Rubber Handle

TR-507S 7pcs Slotted & Phillips Screwdriver Set

4 Slotted:
3.0x155 - 4.0x180 -
6.0x250 - 6.5x250mmL

3 Phillips: #0x75 -
#1x200 - #2x225mmL



920g 5 Sets / 6 Kgs / 0.93 CUFT

TR-508Z 8pcs Combination Screwdriver Set

4 Slotted: 5.5x200 - 6.5x250 - 8.0x280 - 10.0x320mmL

2 Phillips:
#1x200 - #2x225mmL

2 Posidriv:
#1x180 - #2x250mmL



1340g 10 Sets / 14.5 Kgs / 1.58 CUFT

TR-520PZ 20pcs Combination Screwdriver Set

6 Slotted:
3.0x155 - 4.0x180 -
6.0x250 - 6.5x250 -
10.0x320 - 6.5x98mmL

7 Phillips:
#0x155 - #1x200 -
#1x330 - #2x175 - #2x250 -
#3x270 - #1x98mmL

7 Posidriv:
#0x155 - #1x180 -
#1x230 - #2x200 - #2x300 -
#3x295 - #1x98mmL



2580g 4 Sets / 11.5 Kgs / 1.65 CUFT

TR-513ST 13pcs Star Screwdriver Set

13 Star:
T6x150 - T7x150 - T8x150 -
T9x150 - T10x185 - T15x185 -
T20x185 - T25x185 - T27x225 -
T30x225 - T40x235 - T45x235 -
T50x235mmL

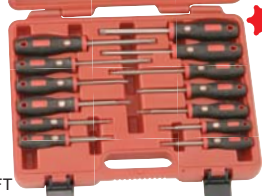

2130g 4 Sets / 10 Kgs / 1.65 CUFT

TR-510TA 10pcs Tamperproof Star Screwdriver Set

10 Tamperproof Star:
T8x150 - T10x180 -
T15x180 - T20x200 -
T25x200 - T27x225 -
T30x225 - T40x255 -
T45x255 - T50x235mmL



1480g 10 Sets / 16 Kgs / 1.58 CUFT

HR-5608M 8pcs Metric Hex Screwdriver Set

8 Metric Hex:
2x150 - 2.5x150 -
3x150 - 4x170 -
5x185 - 6x185 -
7x235 - 8x235mmL



1140g 10 Sets / 14 Kgs / 1.58 CUFT

HR-5611S 11pcs SAE Hex Screwdriver Set

11 SAE Hex: 1/16"x150 -
5/64"x150 - 3/32"x150 -
7/64"x150 - 1/8"x150 -
5/32"x170 - 3/16"x185 -
7/32"x185 - 1/4"x225 -
9/32"x235 - 5/16"x235mmL

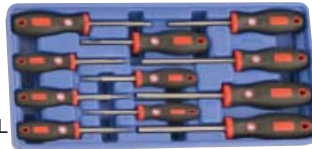

1390g 10 Sets / 16 Kgs / 1.58 CUFT

Screwdriver Sets w/ Rubber Handle

HR-578MW 8pcs Metric Wobble Hex Screwdriver Set

8 Metric Wobble Hex:
3x150 - 4x170 - 5x185 -
6x185 - 7x235 - 8x235 -
9x235 - 10x235mmL



1390g 10 Sets / 16.5 Kgs / 1.58 CUFT

HR-578SW 8pcs SAE Wobble Hex Screwdriver Set

8 SAE Wobble Hex:
1/8"x150 - 5/32"x170 -
3/16"x185 - 7/32"x185 -
1/4"x225 - 9/32"x235 -
5/16"x235 - 3/8"x235mmL



1340g 10 Sets / 15.5 Kgs / 1.58 CUFT

TR-504S 4pcs Square Screwdriver Set

4 Square:
#0x225 - #1x225 -
#2x245 - #3x245mmL



510g 24 Sets / 13.5 Kgs / 1.58 CUFT

Screwdriver Sets w/ Plastic Handle

TL-508X 8pcs Slotted & Phillips Screwdriver Set

4 Slotted: 6.5x86 -
6.5x210 - 8.0x295 -
10.0x320mmL

4 Phillips: #1x86 -
#1x185 - #2x235 -
#2x310mmL



1350g 20 Sets / 28 Kgs / 3.60 CUFT

with large handle

TL-515X 15pcs Slotted, Phillips Screwdriver & Pry Bar Set

6 Slotted: 3.0x170 - 5.0x360 -
6.5x210 - 8.0x295 -
10.0x320 - 6.5x86mmL

8 Phillips: #0x170 - #1x185 -
#1x360 - #2x155 -
#2x235 - #2x310 -
#3x320 - #1x86mmL

1 Pry Bar: 300mmL (12")



2380g 4 Sets / 10 Kgs / 2.60 CUFT

TL-518 18pcs Slotted & Phillips Screwdriver Set

5 Slotted: 5.0x345 -
6.5x195 - 10.0x310 -
10.0x360 - 6.5x86mmL

7 Phillips: #1x170 - #1x345 -
#2x140 - #2x295 - #2x395 -
#3x310 - #1x86mmL

3 Micro-Tech Slotted:
2.0 - 2.5 - 3.0mm

3 Micro-Tech Phillips:
#000 - #00 - #0

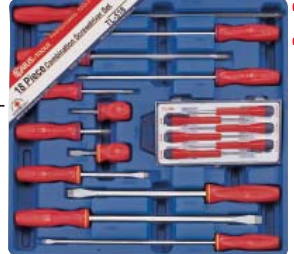

2360g 10 Sets / 24.5 Kgs / 3.60 CUFT

Screwdrivers

Nut Driver Sets

ND-012M 12pcs Metric Hex Nut Driver Set

12 Nut Driver
(593744 ~ 595764)
4 - 5 - 5.5 - 6 - 7 - 8 -
9 - 10 - 11 - 12 - 13 -
14mm



6 pl.

1400g 12 Sets / 18 Kgs / 1.0 CUFT

ND-007S 7pcs SAE Hex Nut Driver Set

7 Nut Driver
(593712 ~ 595732)
3/16 - 1/4 - 5/16 - 11/32 -
3/8 - 7/16 - 1/2"



6 pl.

940g 20 Sets / 20 Kgs / 1.2 CUFT

ND-012MD 12pcs Metric Long Hex Nut Driver Set

12 Long Nut Driver
(593844 ~ 595864)
4 - 5 - 5.5 - 6 - 7 -
8 - 9 - 10 - 11 - 12 -
13 - 14mm



6 pl.

1720g 12 Sets / 21 Kgs / 1.2 CUFT

ND-007SD 7pcs SAE Long Hex Nut Driver Set

7 Long Nut Driver
(593812 ~ 595832)
3/16 - 1/4 - 5/16 - 11/32 -
3/8 - 7/16 - 1/2"



6 pl.

1100g 20 Sets / 23 Kgs / 1.2 CUFT

1/4" Hex Shank Nut Drivers

NEW

6 pl. Metric Hex Nut Drivers

ITEM NO.	Size mm	Hex Shank	Length mm
0444	4	1/4"	140
0445	5	1/4"	140
0455	5.5	1/4"	140
0456	6	1/4"	140
0457	7	1/4"	140
0458	8	1/4"	140
0459	9	1/4"	140
0460	10	1/4"	140
0461	11	1/4"	140
0462	12	1/4"	140
0463	13	1/4"	140
0464	14	1/4"	140

6 pl. SAE Hex Nut Drivers

ITEM NO.	Size Inch	Hex Shank	Length mm
0512	3/16	1/4"	140
0516	1/4	1/4"	140
0520	5/16	1/4"	140
0522	11/32	1/4"	140
0524	3/8	1/4"	140
0528	7/16	1/4"	140
0532	1/2	1/4"	140

NEW

Micro-Tech Screwdriver Sets

TL-506A 6pcs Slotted & Philips Micro-Tech Screwdriver Set

3 Slotted: 1.2 - 1.6 - 2.0mm
(122mmL)

3 Philips:
#000 - #00 - #0
(122mmL)



+

160g 40 Sets / 7.5 Kgs / 0.73 CUFT

MT-508L 8pcs Slotted & Philips Micro-Tech Screwdriver Set

3 Slotted:
1.2 - 1.6 - 2.0 - 2.5 -
3.0mm (150mmL)

3 Philips: #000 -
#00 - #0 (150mmL)



+

200g 40 Sets / 9.0 Kgs / 0.73 CUFT

MT-5208 8pcs Star Micro-Tech Screwdriver Set

8 Star:
T5 - T6 - T7 - T8 -
T9 - T10 - T15 - T20
(150mmL)



200g 40 Sets / 9.0 Kgs / 0.73 CUFT

MT-5306 6pcs Metric Hex Micro-Tech Screwdriver Set

6 Hex:
0.9 - 1.3 - 1.5mm
(122mmL)

Hex:
2.0 - 2.5 - 3.0mm
(150mmL)



+

160g 40 Sets / 7.5 Kgs / 0.73 CUFT

MT-5405 5pcs SAE Hex Micro-Tech Screwdriver Set

5 SAE Hex:
0.05" - 1/16"
(122mmL)

SAE Hex:
5/64 - 3/32 - 7/64"
(150mmL)



+

150g 40 Sets / 7.5 Kgs / 0.73 CUFT

NB-021M 21pcs Metric Hex Nut Driver & Bit Set

7 Hex Bits (2622 ~ 2648)
2.5 - 3 - 4 - 5 - 6 - 7 -
8mm (125mmL)

12 Nut Drivers (0444 ~ 0464)
4 - 5 - 5.5 - 6 - 7 - 8 - 9 -
10 - 11 - 12 - 13 - 14mm
(140mmL)

1 OMNIDRIVE® 3in1 Handgrip
1/4" & 5/16" Hex Shank (280120)

1 1/4" Hex Shank
Ratcheting Screwdriver
(524+2982) 162mmL



6 pl.

1800g 5 Sets / 10 Kgs / 1.01 CUFT

ND-020MS 20pcs Metric & SAE Hex Nut Driver Set

12 Nut Drivers (0444 ~ 0464)
4 - 5 - 5.5 - 6 - 7 - 8 - 9 -
10 - 11 - 12 - 13 - 14mm
(140mmL)

7 Nut Drivers (0512 ~ 0532)
3/16 - 1/4 - 5/16 - 11/32 -
3/8 - 7/16 - 1/2" (140mmL)

1 1/4" Hex Shank
Ratcheting Screwdriver
(524+2982) 162mmL



6 pl.

1800g 5 Sets / 10 Kgs / 1.01 CUFT

Air Ratchets

205051X 1/4" Dr. Stubby Air Ratchet

Specifications:

Air Pressure 90 psig / 620 kpa
 Torque Range 5-20 ft.lb. / 7-27 Nm
 Max. Torque 20 ft.lb. / 27 Nm
 Free Speed 240 rpm
 Standard Bolt Cap 3/8 in. / 10 mm
 Net Weight 1.3 lbs. / 0.6 kgs
 Overall Length 6.3 in. / 160 mm
 Avg. Air Consumption ... 2.5 cfm
 Air Inlet 1/4 in.
 Minimum Hose Size 3/8 in. / 10 mm

🔧 600g 📦 20 pcs / 13.5 Kgs / 0.50 CUFT



305052X 3/8" Dr. Heavy Duty Air Ratchet

Specifications:

Air Pressure 90 psig / 620 kpa
 Torque Range 10-45 ft.lb. / 14-62 Nm
 Max. Torque 50 ft.lb. / 68 Nm
 Free Speed 160 rpm
 Standard Bolt Cap 3/8 in. / 10 mm
 Net Weight 2.64 lbs. / 1.2 kgs
 Overall Length 10 in. / 254 mm
 Avg. Air Consumption ... 4.0 cfm
 Air Inlet 1/4 in.
 Minimum Hose Size 3/8 in. / 10 mm

🔧 1200g 📦 20 pcs / 22.5 Kgs / 0.78 CUFT



405053X 1/2" Dr. Heavy Duty Air Ratchet

Specifications:

Air Pressure 90 psig / 620 kpa
 Torque Range 10-45 ft.lb. / 14-62 Nm
 Max. Torque 50 ft.lb. / 68 Nm
 Free Speed 160 rpm
 Standard Bolt Cap 3/8 in. / 10 mm
 Net Weight 2.4 lbs. / 1.2 kgs
 Overall Length 10 in. / 254 mm
 Avg. Air Consumption ... 4.0 cfm
 Air Inlet 1/4 in.
 Minimum Hose Size 3/8 in. / 10 mm

🔧 1250g 📦 20 pcs / 25.5 Kgs / 0.78 CUFT



405054X 1/2" Dr. Super Duty Air Ratchet

Specifications:

Air Pressure 90 psig / 620 kpa
 Torque Range 10-60 ft.lb. / 14-82 Nm
 Max. Torque 65 ft.lb. / 82 Nm
 Free Speed 150 rpm
 Standard Bolt Cap 3/8 in. / 10 mm
 Net Weight 4.4 lbs. / 2.0 kgs
 Overall Length 14.4 in. / 365 mm
 Avg. Air Consumption ... 4.0 cfm
 Air Inlet 1/4 in.
 Minimum Hose Size 3/8 in. / 10 mm

🔧 2000g 📦 10 pcs / 21.5 Kgs / 0.57 CUFT



⚠ Warning

- Wear proper eye protection
- Use only impact sockets and accessories
- Check the socket carefully for wear, cracks or damage before installation.

⚠ Caution

- Proper use will extend the usage period 2 to 3 times.
- After oiling, remember to first pull the trigger for no longer than 2 seconds. Otherwise, it will seriously affect performance as well as shorten the life of the tool itself.
- Please add 2-3cc #R32 oil to grease the motor everyday before use.
- Please add 20-30cc #R40 oil to grease the impact set every 3 to 6 months.
- Do not drive or remove screws that would require the use of the unit for more than 5 seconds at one time. If the screws are rusty or too tight, please use other method to remove them.

Air Impact Wrenches

300200 3/8" Dr. Super Duty Air Impact Wrench

Specifications:

Air Pressure 90 psig / 620 kpa
 Torque Range 20-160 ft.lb. / 28-218 Nm
 Max. Torque 200 ft.lb. / 271 Nm
 Blows Per Min. 1,500
 Free Speed 10,000 rpm
 Standard Bolt Cap 7/16 in. / 11 mm
 Net Weight 2.97 lbs. / 1.35 kgs
 Overall Length 5.5 in. / 140 mm
 Avg. Air Consumption ... 2.5 cfm
 Air Inlet 1/4 in.
 Minimum Hose Size 3/8 in. / 10 mm
 Machine Design **Jumbo Hammer**

🔧 1350g 📦 12 pcs / 20 Kgs / 1.24 CUFT



400400G 1/2" Dr. Heavy Duty Air Impact Wrench

Specifications:

Air Pressure 90 psig / 620 kpa
 Torque Range 25-285 ft.lb. / 34-387 Nm
 Max. Torque 380 ft.lb. / 516 Nm
 Blows Per Min. 1,200
 Free Speed 7,000 rpm
 Standard Bolt Cap 9/16 in. / 14 mm
 Net Weight 5.94 lbs. / 2.7 kgs
 Overall Length 7.5 in. / 190 mm
 Avg. Air Consumption ... 4.0 cfm
 Air Inlet 1/4 in.
 Minimum Hose Size 3/8 in. / 10 mm
 Machine Design **Pin Clutch**

🔧 2700g 📦 2 pcs / 6.5 Kgs / 0.40 CUFT



400401 1/2" Dr. Super Duty Lightweight Mini Air Impact Wrench

Specifications:

Air Pressure 90 psig / 620 kpa
 Max. Torque 400 ft.lb. / 542 Nm
 Free Speed 11,000 rpm
 Standard Bolt Cap 5/8 in. / 16 mm
 Net Weight 3.6 lbs. / 1.6 kgs
 Overall Length 5.6 in. / 142 mm
 Avg. Air Consumption ... 3.2 cfm
 Air Inlet 1/4 in.
 Minimum Hose Size 3/8 in. / 10 mm
 Machine Design **Twin Hammer**

🔧 1600g 📦 10 pcs / 17 Kgs / 0.70 CUFT



400402 1/2" Dr. Super Duty 2" Extended Anvil Lightweight Mini Air Impact Wrench

Specifications:

Air Pressure 90 psig / 620 kpa
 Max. Torque 400 ft.lb. / 542 Nm
 Free Speed 11,000 rpm
 Standard Bolt Cap 5/8 in. / 16 mm
 Net Weight 3.8 lbs. / 1.7 kgs
 Overall Length 7.6 in. / 192 mm
 Avg. Air Consumption ... 3.2 cfm
 Air Inlet 1/4 in.
 Minimum Hose Size 3/8 in. / 10 mm
 Machine Design **Twin Hammer**

🔧 1700g 📦 10 pcs / 19 Kgs / 0.75 CUFT



400420 1/2" Dr. Super Duty Air Impact Wrench

Specifications:

Air Pressure 90 psig / 620 kpa
 Torque Range 25-300 ft.lb. / 34-408 Nm
 Max. Torque 420 ft.lb. / 570 Nm
 Blows Per Min. 1,200
 Free Speed 7,000 rpm
 Standard Bolt Cap 9/16 in. / 14 mm
 Net Weight 5.9 lbs. / 2.7 kgs
 Overall Length 7.3 in. / 185 mm
 Avg. Air Consumption ... 4.2 cfm
 Air Inlet 1/4 in.
 Minimum Hose Size 3/8 in. / 10 mm
 Machine Design **Twin Hammer**

🔧 2700g 📦 2 pcs / 6.5 Kgs / 0.40 CUFT



Air Impact Wrenches

Air Impact Wrenches

400422 1/2" Dr. Super Duty 2" Extended Anvil Air Impact Wrench

Specifications:
 Air Pressure 90 psig / 620 kpa
 Torque Range 25-300 ft.lb. / 34-408 Nm
 Max. Torque 420 ft.lb. / 570 Nm
 Blows Per Min. 1,200
 Free Speed 7,000 rpm
 Standard Bolt Cap 9/16 in. / 14 mm
 Net Weight 6.16 lbs. / 2.8 kg
 Overall Length 9.3 in. / 235 mm
 Avg. Air Consumption ... 4.2 cfm
 Air Inlet 1/4 in.
 Minimum Hose Size 3/8 in. / 10 mm
 Machine Design **Twin Hammer**
 2800g 2 pcs / 6.7 Kgs / 0.40 CUFT



400450 1/2" Dr. Super Duty Air Impact Wrench

Specifications:
 Air Pressure 90 psig / 620 kpa
 Max. Torque 450 ft.lb. / 610 Nm
 Free Speed 8,000 rpm
 Standard Bolt Cap 9/16 in. / 14 mm
 Net Weight 5.9 lbs. / 2.7 kgs
 Overall Length 7.3 in. / 185 mm
 Avg. Air Consumption ... 4.5 cfm
 Air Inlet 1/4 in.
 Minimum Hose Size 3/8 in. / 10 mm
 Machine Design **Twin Hammer**
 2700g 6 pcs / 18 Kgs / 0.70 CUFT



400452 1/2" Dr. Super Duty 2" Extended Anvil Air Impact Wrench

Specifications:
 Air Pressure 90 psig / 620 kpa
 Max. Torque 450 ft.lb. / 610 Nm
 Free Speed 8,000 rpm
 Standard Bolt Cap 9/16 in. / 14 mm
 Net Weight 6.2 lbs. / 2.8 kgs
 Overall Length 9.3 in. / 235 mm
 Avg. Air Consumption ... 4.5 cfm
 Air Inlet 1/4 in.
 Minimum Hose Size 3/8 in. / 10 mm
 Machine Design **Twin Hammer**
 2800g 6 pcs / 19 Kgs / 0.80 CUFT



400500 1/2" Dr. Super Duty Air Impact Wrench

Specifications:
 Air Pressure 90 psig / 620 kpa
 Torque Range 40-350 ft.lb. / 55-475 Nm
 Max. Torque 500 ft.lb. / 678 Nm
 Blows Per Min. 1,300
 Free Speed 7,000 rpm
 Standard Bolt Cap 5/8 in. / 16 mm
 Net Weight 6.4 lbs. / 2.9 kgs
 Overall Length 7.6 in. / 190 mm
 Avg. Air Consumption ... 5.4 cfm
 Air Inlet 1/4 in.
 Minimum Hose Size 3/8 in. / 10 mm
 Machine Design **Twin Hammer**
 2900g 2 pcs / 6.8 Kgs / 0.40 CUFT



400502 1/2" Dr. Super Duty 2" Extended Anvil Air Impact Wrench

Specifications:
 Air Pressure 90 psig / 620 kpa
 Torque Range 40-350 ft.lb. / 55-475 Nm
 Max. Torque 500 ft.lb. / 678 Nm
 Blows Per Min. 1,300
 Free Speed 7,000 rpm
 Standard Bolt Cap 5/8 in. / 16 mm
 Net Weight 6.6 lbs. / 3.0 kgs
 Overall Length 9.6 in. / 245 mm
 Avg. Air Consumption ... 5.4 cfm
 Air Inlet 1/4 in.
 Minimum Hose Size 3/8 in. / 10 mm
 Machine Design **Twin Hammer**
 3000g 2 pcs / 7.0 Kgs / 0.40 CUFT



Air Impact Wrenches

400800 1/2" Dr. Ultra Duty Air Impact Wrench

Specifications:
 Air Pressure 90 psig / 620 kpa
 Max. Torque 800 ft.lb. / 1085 Nm
 Free Speed 7,500 rpm
 Standard Bolt Cap 1-1/16 in. / 27 mm
 Net Weight 5.6 lbs. / 2.5 kgs
 Overall Length 6.5 in. / 165 mm
 Avg. Air Consumption ... 4.5 cfm
 Air Inlet 1/4 in.
 Minimum Hose Size 3/8 in. / 10 mm
 Machine Design **Twin Hammer**
 2500g 6 pcs / 17 Kgs / 0.70 CUFT



400802 1/2" Dr. Ultra Duty 2" Extended Anvil Air Impact Wrench

Specifications:
 Air Pressure 90 psig / 620 kpa
 Max. Torque 800 ft.lb. / 1085 Nm
 Free Speed 7,500 rpm
 Standard Bolt Cap 1-1/16 in. / 27 mm
 Net Weight 5.8 lbs. / 2.6 kgs
 Overall Length 8.5 in. / 215 mm
 Avg. Air Consumption ... 4.5 cfm
 Air Inlet 1/4 in.
 Minimum Hose Size 3/8 in. / 10 mm
 Machine Design **Twin Hammer**
 2600g 6 pcs / 18 Kgs / 0.80 CUFT



3/8" Dr. Air Impact Wrench Sets

TF-316M1 16pcs 3/8" Dr. Metric Air Impact Wrench Kit

- 1 3/8" Dr. Air Impact Wrench
160 ft.lb. / 217 Nm (300300G)
 - 10 3/8" Dr. Impact Socket (313008 ~ 313021)
8 - 10 - 11 - 12 - 13 - 14 - 16 - 17 - 19 - 21mm
 - 1 3/8" Dr. Extension 75mmL (380029)
 - 1 4mm Hex Key Wrench (570740)
 - 1 Oil Pot (700180)
 - 1 1/4" Air Nipple (700183)
 - 1 1/4" Mini Oiler (700182)
- 3000g 6 Sets / 19 Kgs / 1.40 CUFT



TF-316S1 16pcs 3/8" Dr. SAE Air Impact Wrench Kit

- 1 3/8" Dr. Air Impact Wrench
160 ft.lb. / 217 Nm (300300G)
 - 10 3/8" Dr. Impact Socket (393010 ~ 393028)
5/16 - 3/8 - 7/16 - 1/2 - 9/16 - 5/8 - 11/16 - 3/4 - 13/16 - 7/8"
 - 1 3/8" Dr. Extension 75mmL (380029)
 - 1 4mm Hex Key Wrench (570740)
 - 1 Oil Pot (700180)
 - 1 1/4" Air Nipple (700183)
 - 1 1/4" Mini Oiler (700182)
- 3000g 6 Sets / 19 Kgs / 1.40 CUFT



1/2" Dr. Air Impact Wrench Sets

TF-416K1 16pcs 1/2" Dr. Metric Air Impact Wrench Kit

- 1 1/2" Dr. Air Impact Wrench
230 ft.lb. / 312 Nm (400230)
- 10 1/2" Dr. Impact Socket (413809 ~ 413827)
9 - 10 - 11 - 13 - 14 - 17 - 19 - 22 - 24 - 27mm
- 1 1/2" Dr. Extension 125mmL (480036)
- 1 4mm Hex Key Wrench (570740)
- 1 Oil Pot (700180)
- 1 1/4" Air Nipple (700183)
- 1 1/4" Mini Oiler (700182)

4300g 4 Sets / 18.5 Kgs / 1.40 CUFT



TF-416S1 16pcs 1/2" Dr. SAE Air Impact Wrench Kit

- 1 1/2" Dr. Air Impact Wrench
230 ft.lb. / 312 Nm (400230)
- 10 1/2" Dr. Impact Socket (493814 ~ 493832)
7/16 - 1/2 - 9/16 - 5/8 - 11/16 - 3/4 - 13/16 - 7/8 - 15/16 - 1"
- 1 1/2" Dr. Extension 5"L (480036)
- 1 4mm Hex Key Wrench (570740)
- 1 Oil Pot (700180)
- 1 1/4" Air Nipple (700183)
- 1 1/4" Mini Oiler (700182)

4300g 4 Sets / 18.5 Kgs / 1.40 CUFT



GS-425K 27pcs 1/2" Dr. Metric Air Impact Wrench Set

- 1 1/2" Dr. Air Impact Wrench
230 ft.lb. / 312 Nm (400230)
- 17 1/2" Dr. Impact Socket (444008 ~ -30)
8 - 9 - 10 - 11 - 12 - 13 - 14 - 15 - 16 - 17 - 18 - 19 - 21 - 22 - 24 - 27 - 30mm
- 4 Adapter 3/8"Fx1/2"M (340040B) -
1/2"Fx3/8"M (480033MB) -
1/2"Fx3/4"M (480066MB) -
3/4"Fx1/2"M (640604B)
- 1 1/2" Dr. Ext. 75mmL (480032MB)
- 1 1/2" Dr. Sliding T-Handle (480040)
- 1 4mm Hex Key Wrench (570740)
- 1 Oil Pot (700180)
- 1 1/4" Air Nipple (700183)

7000g 2 Sets / 15.5 Kgs / 1.42 CUFT



GS-425KS* 27pcs 1/2" Dr. SAE Air Impact Wrench Set

- 1 1/2" Dr. Air Impact Wrench
230 ft.lb. / 312 Nm (400230)
- 17 1/2" Dr. Impact Socket (464010 ~ -40)
5/16 - 3/8 - 7/16 - 1/2 - 9/16 - 19/32 - 5/8 - 11/16 - 3/4 - 13/16 - 7/8 - 15/16 - 1 - 1 1/16 - 1 1/8 - 1 3/16 - 1 1/4"
- 4 Adapter 3/8"Fx1/2"M (340040B) -
1/2"Fx3/8"M (480033MB) -
1/2"Fx3/4"M (480066MB) -
3/4"Fx1/2"M (640604B)
- 1 1/2" Dr. Ext. 3"L (480032MB)
- 1 1/2" Dr. Sliding T-Handle (480040)
- 1 4mm Hex Key Wrench (570740)
- 1 Oil Pot (700180)
- 1 1/4" Air Nipple (700183)

7000g 2 Sets / 15.5 Kgs / 1.42 CUFT



*GS-425KS has the same blow molded case as shown except it is in gray color box.

3/4" Dr. Air Impact Wrenches

600750 3/4" Dr. Heavy Duty Air Impact Wrench

Specifications:
 Air Pressure 90 psig / 620 kpa
 Torque Range 150-550 ft.lb. / 204-746 Nm
 Max. Torque 750 ft.lb. / 1,016 Nm
 Blows Per Min. 1,000
 Free Speed 6,500 rpm
 Standard Bolt Cap 1 in. / 26 mm
 Net Weight 10 lbs. / 4.55 kgs
 Overall Length 9 in. / 230 mm
 Avg. Air Consumption ... 7.0 cfm
 Air Inlet 1/4 in.
 Minimum Hose Size 3/8 in. / 10 mm
 Machine Design **Twin Hammer**

4550g 2 pcs / 10.5 Kgs / 0.70 CUFT



600756 3/4" Dr. Heavy Duty 6" Extended Anvil Air Impact Wrench

Specifications:
 Air Pressure 90 psig / 620 kpa
 Torque Range 150-550 ft.lb. / 204-746 Nm
 Max. Torque 750 ft.lb. / 1,016 Nm
 Blows Per Min. 1,000
 Free Speed 6,500 rpm
 Standard Bolt Cap 1 in. / 26 mm
 Net Weight 11.3 lbs. / 5.14 kgs
 Overall Length 15 in. / 380 mm
 Avg. Air Consumption ... 7.0 cfm
 Air Inlet 1/4 in.
 Minimum Hose Size 3/8 in. / 10 mm
 Machine Design **Twin Hammer**

5200g 2 pcs / 11.5 Kgs / 0.70 CUFT



600850 3/4" Dr. Super Duty Lightweight Air Impact Wrench

Specifications:
 Air Pressure 90 psig / 620 kpa
 Max. Torque 850 ft.lb. / 1152 Nm
 Free Speed 7,500 rpm
 Standard Bolt Cap 1-1/8 in. / 29 mm
 Net Weight 5.6 lbs. / 2.5 kgs
 Overall Length 6.7 in. / 170 mm
 Avg. Air Consumption ... 4.5 cfm
 Air Inlet 1/4 in.
 Minimum Hose Size 3/8 in. / 10 mm
 Machine Design **Twin Hammer**

2500g 6 pcs / 17 Kgs / 0.70 CUFT



600856 3/4" Dr. Super Duty 6" Extended Anvil Lightweight Air Impact Wrench

Specifications:
 Air Pressure 90 psig / 620 kpa
 Max. Torque 850 ft.lb. / 1152 Nm
 Free Speed 7,500 rpm
 Standard Bolt Cap 1-1/8 in. / 29 mm
 Net Weight 6.9 lbs. / 3.1 kgs
 Overall Length 12.8 in. / 325 mm
 Avg. Air Consumption ... 4.5 cfm
 Air Inlet 1/4 in.
 Minimum Hose Size 3/8 in. / 10 mm
 Machine Design **Twin Hammer**

3100g 6 pcs / 21 Kgs / 1.40 CUFT



601100 3/4" Dr. Super Duty Air Impact Wrench

Specifications:
 Air Pressure 90 psig / 620 kpa
 Max. Torque 1,100 ft.lb. / 1491 Nm
 Free Speed 6,000 rpm
 Standard Bolt Cap 1-7/16 in. / 36 mm
 Net Weight 9.1 lbs. / 4.1 kgs
 Overall Length 8.2 in. / 208 mm
 Avg. Air Consumption ... 6.0 cfm
 Air Inlet 1/4 in.
 Minimum Hose Size 3/8 in. / 10 mm
 Machine Design **Twin Hammer**

4100g 4 pcs / 18.6 Kgs / 0.85 CUFT



Air Impact Wrenches

3/4" Dr. Air Impact Wrenches

601106 3/4" Dr. Super Duty 6" Extended Anvil Air Impact Wrench

Specifications:
 Air Pressure 90 psig / 620 kpa
 Max. Torque 1,100 ft.lb. / 1491 Nm
 Free Speed 6,000 rpm
 Standard Bolt Cap 1-1/4 in. / 32 mm
 Net Weight 10.5 lbs. / 4.7 kgs
 Overall Length 14.2 in. / 360 mm
 Avg. Air Consumption ... 6.0 cfm
 Air Inlet 1/4 in.
 Minimum Hose Size 3/8 in. / 10 mm
 Machine Design **Twin Hammer**
 4700g 4 pcs / 21.5 Kgs / 1.30 CUFT

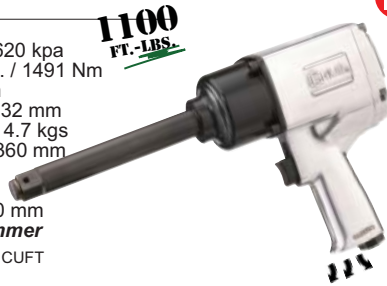

1" Dr. Air Impact Wrenches

801600 1" Dr. Super Duty Air Impact Wrench

Specifications:
 Air Pressure 90 psig / 620 kpa
 Torque Range 300-1,000 ft.lb. / 407-1,356 Nm
 Max. Torque 1,600 ft.lb. / 2,169 Nm
 Blows Per Min. 750
 Free Speed 6,000 rpm
 Standard Bolt Cap 1-1/4 in. / 32mm
 Net Weight 24 lbs. / 11 kgs
 Overall Length 17.1 in. / 435 mm
 Avg. Air Consumption ... 13.2 cfm
 Air Inlet 1/2 in.
 Minimum Hose Size 3/4 in. / 19 mm
 Machine Design **Twin Hammer**
 11,000g 1 pcs / 12 Kgs / 0.97 CUFT



1" Dr. Air Impact Wrenches

801200 1" Dr. Heavy Duty Lightweight Air Impact Wrench

Specifications:
 Air Pressure 90 psig / 620 kpa
 Max. Torque 1,200 ft.lb. / 1627 Nm
 Free Speed 6,000 rpm
 Standard Bolt Cap 1-1/2 in. / 38 mm
 Net Weight 9.3 lbs. / 4.2 kgs
 Overall Length 8.5 in. / 216 mm
 Avg. Air Consumption ... 6.0 cfm
 Air Inlet 1/4 in.
 Minimum Hose Size 3/8 in. / 10 mm
 Machine Design **Twin Hammer**
 4200g 4 pcs / 19 Kgs / 0.85 CUFT



801606 1" Dr. Super Duty 4" Extended Anvil Air Impact Wrench

Specifications:
 Air Pressure 90 psig / 620 kpa
 Torque Range 300-1,000 ft.lb. / 407-1,356 Nm
 Max. Torque 1,600 ft.lb. / 2,169 Nm
 Blows Per Min. 750
 Free Speed 6,000 rpm
 Standard Bolt Cap 1-1/4 in. / 32 mm
 Net Weight 26.4 lbs. / 12 kgs
 Overall Length 21 in. / 535 mm
 Avg. Air Consumption ... 13.2 cfm
 Air Inlet 1/2 in.
 Minimum Hose Size 3/4 in. / 19 mm
 Machine Design **Twin Hammer**
 12,000g 1 pcs / 13 Kgs / 0.97 CUFT



801206 1" Dr. Heavy Duty 6" Extended Anvil Lightweight Air Impact Wrench

Specifications:
 Air Pressure 90 psig / 620 kpa
 Max. Torque 1,200 ft.lb. / 1627 Nm
 Free Speed 6,000 rpm
 Standard Bolt Cap 1-1/2 in. / 38 mm
 Net Weight 11.4 lbs. / 5.1 kgs
 Overall Length 14.5 in. / 368 mm
 Avg. Air Consumption ... 6.0 cfm
 Air Inlet 1/4 in.
 Minimum Hose Size 3/8 in. / 10 mm
 Machine Design **Twin Hammer**
 5100g 4 pcs / 23 Kgs / 1.30 CUFT



801800 1" Dr. Super Duty Air Impact Wrench

Specifications:
 Air Pressure 90 psig / 620 kpa
 Torque Range 500-1,400 ft.lb. / 677-1,898 Nm
 Max. Torque 1,800 ft.lb. / 2,439 Nm
 Blows Per Min. 820
 Free Speed 4,000 rpm
 Standard Bolt Cap 1-1/4 in. / 32mm
 Net Weight 24.6 lbs. / 11.2 kgs
 Overall Length 16.5 in. / 420mm
 Avg. Air Consumption ... 13.2 cfm
 Air Inlet 1/2 in.
 Minimum Hose Size 3/4 in. / 19 mm
 Machine Design **Twin Hammer**
 11,200g 1 pcs / 12 Kgs / 0.97 CUFT



801500 1" Dr. Heavy Duty Air Impact Wrench

Specifications:
 Air Pressure 90 psig / 620 kpa
 Torque Range 150-1,000 ft.lb. / 204-1,356 Nm
 Max. Torque 1,500 ft.lb. / 2,033 Nm
 Blows Per Min. 750
 Free Speed 4,000 rpm
 Standard Bolt Cap 1-1/4 in. / 32mm
 Net Weight 22 lbs. / 10 kgs
 Overall Length 14.5 in. / 370 mm
 Avg. Air Consumption ... 13.2 cfm
 Air Inlet 1/2 in.
 Minimum Hose Size 3/4 in. / 19 mm
 Machine Design **Twin Hammer**
 10,000g 1 pcs / 11 Kgs / 0.97 CUFT



801806 1" Dr. Super Duty 4" Extended Anvil Air Impact Wrench

Specifications:
 Air Pressure 90 psig / 620 kpa
 Torque Range 500-1,400 ft.lb. / 677-1,898 Nm
 Max. Torque 1,800 ft.lb. / 2,439 Nm
 Blows Per Min. 820
 Free Speed 4,000 rpm
 Standard Bolt Cap 1-1/4 in. / 32 mm
 Net Weight 27.5 lbs. / 12.5 kgs
 Overall Length 20.5 in. / 520 mm
 Avg. Air Consumption ... 13.2 cfm
 Air Inlet 1/2 in.
 Minimum Hose Size 3/4 in. / 19 mm
 Machine Design **Twin Hammer**
 12,500g 1 pcs / 14 Kgs / 0.97 CUFT



801506 1" Dr. Heavy Duty 6" Extended Anvil Air Impact Wrench

Specifications:
 Air Pressure 90 psig / 620 kpa
 Torque Range 150-1,000 ft.lb. / 204-1,356 Nm
 Max. Torque 1,500 ft.lb. / 2,033 Nm
 Blows Per Min. 750
 Free Speed 4,000 rpm
 Standard Bolt Cap 1-1/4 in. / 32 mm
 Net Weight 24.8 lbs. / 11.3 kgs
 Overall Length 20.5 in. / 520 mm
 Avg. Air Consumption ... 13.2 cfm
 Air Inlet 1/2 in.
 Minimum Hose Size 3/4 in. / 19 mm
 Machine Design **Twin Hammer**
 11,300g 1 pcs / 13 Kgs / 0.97 CUFT



Combination Wrenches

**Metric
Combination Wrenches
- Chrome Finish**

ITEM NO.	Size mm	Length mm
748206	6	130
748207	7	135
748208	8	142
748209	9	154
748210	10	162
748211	11	170
748212	12	175
748213	13	180
748214	14	195
748215	15	205
748216	16	205
748217	17	228
748218	18	228
748219	19	250
748220	20	250
748221	21	270
748222	22	295
748223	23	295
748224	24	315
748225	25	338
748226	26	338
748227	27	360
748228	28	360
748239	29	395
748230	30	395
748232	32	430

**SAE
Combination Wrenches
- Chrome Finish**

ITEM NO.	Size Inch	Length mm
759208	1/4	130
759210	5/16	142
759212	3/8	154
759214	7/16	170
759216	1/2	180
759218	9/16	195
759220	5/8	205
759222	11/16	228
759224	3/4	250
759226	13/16	270
759228	7/8	295
759230	15/16	315
759232	1	338
759234	1-1/16	360
759236	1-1/8	395
759240	1-1/4	430

Combination Wrench Sets

PR-015M 15pcs Metric Combination Wrench Set

15 Metric Combination (748207 ~ -24)
7 - 8 - 9 - 10 - 11 - 12 - 13 - 14 - 15 - 16 - 17 - 18 - 19 - 22 - 24mm



1/3 Tray
2300g 10 Sets / 26.5 Kgs / 1.58 CUFT

PR-017M 17pcs Metric Combination Wrench Set

17 Metric Combination (748206 ~ -22)
6 - 7 - 8 - 9 - 10 - 11 - 12 - 13 - 14 - 15 - 16 - 17 - 18 - 19 - 20 - 21 - 22mm



2630g 8 Sets / 22 Kgs / 0.82 CUFT

PR-026M 26pcs Metric Combination Wrench Set

26 Metric Combination (748206 ~ -32)
6 - 7 - 8 - 9 - 10 - 11 - 12 - 13 - 14 - 15 - 16 - 17 - 18 - 19 - 20 - 21 - 22 - 23 - 24 - 25 - 26 - 27 - 28 - 29 - 30 - 32mm

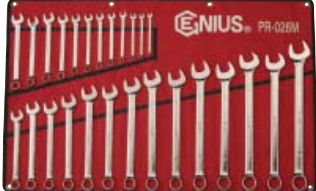

8000g 2 Sets / 17 Kgs / 0.60 CUFT

Combination Wrench Sets

PR-011S 11pcs SAE Combination Wrench Set

11 SAE Combination (759210 ~ -32)
5/16 - 3/8 - 7/16 - 1/2 - 9/16 - 5/8 - 11/16 - 3/4 - 7/8 - 15/16 - 1"



2300g 6 Sets / 15.5 Kgs / 0.65 CUFT

PR-016S 16pcs SAE Combination Wrench Set

16 SAE Combination (759208 ~ -40)
1/4 - 5/16 - 3/8 - 7/16 - 1/2 - 9/16 - 5/8 - 11/16 - 3/4 - 13/16 - 7/8 - 15/16 - 1" - 1 1/16 - 1 1/8 - 1 1/4"



5000g 4 Sets / 21 Kgs / 0.74 CUFT

Jumbo Combination Wrenches

**Metric Jumbo
Combination Wrenches
- Satin Finish**

ITEM NO.	Size mm	Length mm
726032	32	430
726033	33	461
726034	34	461
726035	35	461
726036	36	486
726038	38	486
726040	40	540
726041	41	540
726042	42	540
726045	45	611
726046	46	611
726050	50	611
726055	55	666
726060	60	760
726065	65	760

**SAE Jumbo
Combination Wrenches
- Satin Finish**

ITEM NO.	Size Inch	Length mm
737042	1-5/16	461
737044	1-3/8	461
737046	1-7/16	486
737048	1-1/2	486
737052	1-5/8	540
737054	1-11/16	540
737056	1-3/4	611
737058	1-13/16	611
737060	1-7/8	611
737064	2	611
737068	2-1/8	665
737072	2-1/4	665
737076	2-3/8	760
737080	2-1/2	760

Wrenches

Combination Ratcheting Wrenches

Metric Combination Ratcheting Wrenches - Chrome Finish



ITEM NO.	Size mm	Length mm
768508	8	136
768510	10	160
768511	11	168
768512	12	174
768513	13	180
768514	14	193
768515	15	200
768516	16	216
768517	17	233
768518	18	239
768519	19	250
768521	21	285
768522	22	285
768523	23	285
768524	24	325
768525	25	325
768526	26	325
768527	27	355
768528	28	355
768530	30	425
768532	32	425

SAE Combination Ratcheting Wrenches - Chrome Finish



ITEM NO.	Size Inch	Length mm
778510	5/16	136
778512	3/8	160
778514	7/16	168
778516	1/2	180
778518	9/16	193
778520	5/8	216
778522	11/16	233
778524	3/4	250
778526	13/16	285
778528	7/8	285
778530	15/16	325
778532	1	325
778534	1-1/16	355
778536	1-1/8	425
778540	1-1/4	425

Combination Ratcheting Wrench Sets

GW-7611M 11pcs Metric Combination Ratcheting Wrench Set

11 Metric Combination (768508 ~ -19)

8 - 10 - 11 - 12 - 13 - 14 - 15 - 16 - 17 - 18 - 19mm



1690g 8 Sets / 14.5 Kgs / 0.70 CUFT

GW-7617M 17pcs Metric Combination Ratcheting Wrench Set

17 Metric Combination (768508 ~ -32)

8 - 10 - 11 - 12 - 13 - 14 - 15 - 16 - 17 - 18 - 19 - 21 - 22 - 24 - 27 - 30 - 32mm



6330g 3 Sets / 20.5 Kgs / 1.68 CUFT

GW-7708S 8pcs SAE Combination Ratcheting Wrench Set

8 SAE Combination (778510 ~ -24)

5/16 - 3/8 - 7/16 - 1/2 - 9/16 - 5/8 - 11/16 - 3/4"



1190g 8 Sets / 10.5 Kgs / 0.70 CUFT

GW-7715S 15pcs SAE Combination Ratcheting Wrench Set

15 SAE Combination (778510 ~ -40)

5/16 - 3/8 - 7/16 - 1/2 - 9/16 - 5/8 - 11/16 - 3/4 - 13/16 - 7/8 - 15/16 - 1" - 1 1/16 - 1 1/8 - 1 1/4"



6380g 3 Sets / 20.5 Kgs / 1.68 CUFT

Stubby Combination Ratcheting Wrenches

Metric Stubby Combination Ratcheting Wrenches - Chrome Finish



ITEM NO.	Size mm	Length mm
760210	10	96
760211	11	100
760212	12	104
760213	13	108
760214	14	114
760215	15	118
760216	16	122
760217	17	128
760218	18	132
760219	19	138

SAE Stubby Combination Ratcheting Wrenches - Chrome Finish



ITEM NO.	Size Inch	Length mm
770212	3/8	96
770214	7/16	100
770216	1/2	108
770218	9/16	114
770220	5/8	122
770222	11/16	128
770224	3/4	138

Stubby Combination Ratcheting Wrench Sets

GW-7610M 10pcs Metric Stubby Combination Ratcheting Wrench

10 Metric Combination (760210 ~ -19)

10 - 11 - 12 - 13 - 14 - 15 - 16 - 17 - 18 - 19mm



1130g 8 Sets / 10 Kgs / 0.70 CUFT

GW-7707S 7pcs SAE Stubby Combination Ratcheting Wrench Set

7 SAE Combination (770212 ~ -24)

3/8 - 7/16 - 1/2 - 9/16 - 5/8 - 11/16 - 3/4"



820g 8 Sets / 7.5 Kgs / 0.70 CUFT

Offset Box End Wrenches

Metric Offset Box Wrenches - Chrome Finish



ITEM NO.	Size mm	Length mm
740607	6 x 7	165
740809	8 x 9	180
741011	10 x 11	200
741213	12 x 13	220
741415	14 x 15	240
741617	16 x 17	255
741819	18 x 19	275
742022	20 x 22	295
742123	21 x 23	315
742426	24 x 26	330
742528	25 x 28	350
742729	27 x 29	365
743032	30 x 32	365

SAE Offset Box Wrenches - Chrome Finish



ITEM NO.	Size Inch	Length mm
750810	1/4 x 5/16	170
751214	3/8 x 7/16	200
751618	1/2 x 9/16	230
752022	5/8 x 11/16	260
752426	3/4 x 13/16	285
752830	7/8 x 15/16	315
753234	1 x 1-1/16	350
753640	1-1/8 x 1-1/4	360

DE-707M 7pcs Metric Offset Box End Wrench Set

7 Metric Box End (740607 ~ -1819)

6x7 - 8x9 - 10x11 - 12x13 - 14x15 - 16x17 - 18x19mm



1/3 Tray 1340g 10 Sets / 14.5 Kgs / 1.58 CUFT

Offset Box End Wrench Sets

DE-708M 8pcs Metric Offset Box End Wrench Set

8 Metric Box End (740607 ~ -2022)
6x7 - 8x9 - 10x11 - 12x13 - 14x15 - 16x17 - 18x19 - 20x22mm

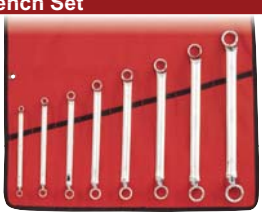

1450g 9 Sets / 14 Kgs / 1.90 CUFT

DE-713M 13pcs Metric Offset Box End Wrench Set

13 Metric Box End (740607 ~ -3032)
6x7 - 8x9 - 10x11 - 12x13 - 14x15 - 16x17 - 18x19 - 20x22 - 21x23 - 24x26 - 25x28 - 27x29 - 30x32mm

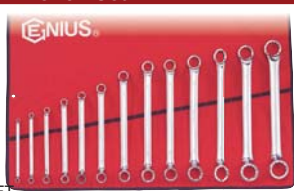

4330g 6 Sets / 27.5 Kgs / 1.70 CUFT

DE-706S 6pcs SAE Offset Box End Wrench Set

6 SAE Box End (750810 ~ -2830)
1/4x5/16 - 3/8x7/16 - 1/2x9/16 - 5/8x11/16 - 3/4x13/16 - 7/8x15/16"

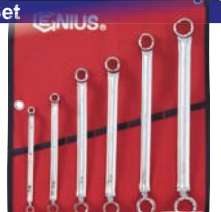

1400g 9 Sets / 13.5 Kgs / 1.90 CUFT

DE-708S 8pcs SAE Offset Box End Wrench Set

8 SAE Box End (750810 ~ -3640)
1/4x5/16 - 3/8x7/16 - 1/2x9/16 - 5/8x11/16 - 3/4x13/16 - 7/8x15/16 - 1"x1 1/16 - 1 1/8x1 1/4"



2670g 9 Sets / 25.5 Kgs / 1.90 CUFT

Flare Nut Wrenches

Metric Flare Nut Wrenches - Chrome Finish

ITEM NO.	Size mm	Length mm
740911	9 x 11	127
741012	10 x 12	141
741314	13 x 14	157
741517	15 x 17	173
741618	16 x 18	181
741921	19 x 21	194

SAE Flare Nut Wrenches - Chrome Finish

ITEM NO.	Size Inch	Length mm
760810	1/4 x 5/16	105
761214	3/8 x 7/16	133
761618	1/2 x 9/16	157
762022	5/8 x 11/16	181
762428	3/4 x 7/8	193



FN-006M 6pcs Metric Flare Nut Wrench Set

6 Metric Flare Nut (740911 ~ -1921)
9x11 - 10x12 - 13x14 - 15x17 - 16x18 - 19x21mm



840g 12 Sets / 11 Kgs / 0.63 CUFT

FN-005S 5pcs SAE Flare Nut Wrench Set

5 SAE Flare Nut (760810 ~ -2428)
1/4x5/16 - 3/8x7/16 - 1/2x9/16 - 5/8x11/16 - 3/4x7/8"



670g 12 Sets / 9 Kgs / 0.63 CUFT

Extra Long Box End Wrenches

Metric Extra Long Box Wrenches - Chrome Finish

ITEM NO.	Size mm	Length mm
780810L	8 x 10	235
781012L	10 x 12	292
781214L	12 x 14	330
781315L	13 x 15	330
781417L	14 x 17	369
781618L	16 x 18	407
781719L	17 x 19	407
782224L	22 x 24	435

SAE Extra Long Box Wrenches - Chrome Finish

ITEM NO.	Size Inch	Length mm
791012L	5/16 x 3/8	235
791416L	7/16 x 1/2	292
791820L	9/16 x 5/8	369
792224L	11/16 x 3/4	407

DE-706M 6pcs Metric Extra Long Box End Wrench Set

6 Metric Box End (781012L ~ -1719L)
10x12 (292mmL) - 12x14 (330mmL) - 13x15 (330mmL) - 14x17 (369mmL) - 16x18 (407mmL) - 17x19 (407mmL)

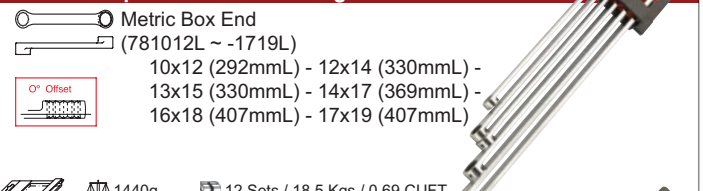

1440g 12 Sets / 18.5 Kgs / 0.69 CUFT

DE-704S 4pcs SAE Extra Long Box End Wrench Set

4 SAE Box End (791012L ~ -2224L)
5/16x3/8 (235mmL) - 7/16x1/2 (292mmL) - 9/16x5/8 (369mmL) - 11/16x3/4 (407mmL)

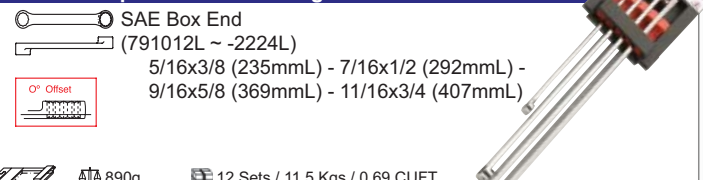

890g 12 Sets / 11.5 Kgs / 0.69 CUFT

E-Star Wrenches

E-Star Wrenches - Chrome Finish

ITEM NO.	Size	Length mm
790608	E-6 x E-8	112
791012	E-10 x E-12	141
791418	E-14 x E-18	181
792024	E-20 x E-24	225

TX-E04 4pcs E-Star Wrench Set

4 E-Star (790608 ~ -2024)
E6xE8 - E10xE12 - E14xE18 - E20xE24



400g 20 Sets / 9 Kgs / 0.60 CUFT

TX-2324 24pcs Star Wrench Set

4 E-Star (790608 ~ -2024)
E6xE8 - E10xE12 - E14xE18 - E20xE24

7 3/8" Dr. E-Star Socket (353510 ~ -20)
E10 - 11 - 12 - 14 - 16 - 18 - 20

10 Tamperproof Star Bit (7108 ~ 7150)
T8 - 10 - 15 - 20 - 25 - 27 - 30 - 40 - 45 - 50 (30mmL)

3 Bit Holder 1/4"Dr.x1/4" - 3/8"Dr.x1/4" - 3/8"Dr.x5/16"



980g 10 Sets / 11 Kgs / 0.93 CUFT

Wrenches

Open End Wrenches

Metric Open End Wrenches - Satin Finish

ITEM NO.	Size mm	Length mm
790607	6 x 7	122
790809	8 x 9	140
791011	10 x 11	156
791213	12 x 13	172
791415	14 x 15	188
791617	16 x 17	204
791819	18 x 19	220
792022	20 x 22	234
792123	21 x 23	247
792426	24 x 26	266
792528	25 x 28	285
792730	27 x 30	302
793032	30 x 32	302

SAE Open End Wrenches - Satin Finish

ITEM NO.	Size Inch	Length mm
770810	1/4 x 5/16	122
771214	3/8 x 7/16	156
771618	1/2 x 9/16	180
772022	5/8 x 11/16	204
772428	3/4 x 7/8	234
772628	13/16 x 7/8	247
773032	15/16 x 1	266
773236	1 x 1-1/8	285
773440	1-1/16 x 1-1/4	302

Open End Wrench Sets

OW-708M 8pcs Metric Open End Wrench Set

8 Metric Open End (790607 ~ -2022)
6x7 - 8x9 - 10x11 - 12x13 - 14x15 - 16x17 - 18x19 - 20x22mm



920g 10 Sets / 10.5 Kgs / 0.62 CUFT

OW-713M 13pcs Metric Open End Wrench Set

13 Metric Open End (790607 ~ -3032)
6x7 - 8x9 - 10x11 - 12x13 - 14x15 - 16x17 - 18x19 - 20x22 - 21x23 - 24x26 - 25x28 - 27x30 - 30x32mm



3000g 4 Sets / 13.5 Kgs / 0.82 CUFT

OW-706S 6pcs SAE Open End Wrench Set

6 SAE Open End (770810 ~ -3032)
1/4x5/16 - 3/8x7/16 - 1/2x9/16 - 5/8x11/16 - 3/4x7/8 - 15/16x1"



940g 12 Sets / 12.5 Kgs / 0.59 CUFT

OW-709S 9pcs SAE Open End Wrench Set

9 SAE Open End (770810 ~ -3440)
1/4x5/16 - 3/8x7/16 - 1/2x9/16 - 5/8x11/16 - 3/4x7/8 - 13/16x7/8 - 15/16x1" - 1"x1 1/8" - 1 1/16x1 1/4"

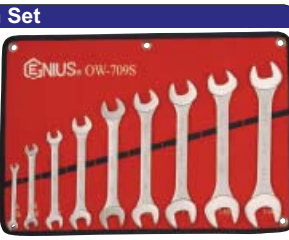

2160g 6 Sets / 14 Kgs / 0.71 CUFT

Hex Key Wrenches

Metric Hex Key Wrenches

ITEM NO.	Size mm	Length mm
570515	1.5	45
570520	2	50
570625	2.5	56
570630	3	62
570735	3.5	66
570740	4	70
570845	4.5	75
570850	5	80
570855	5.5	85
570960	6	90
570970	7	93
571080	8	100
571190	9	109
571210	10	112
571211	11	118
571312	12	125
571313	13	132
571414	14	140
571516	16	150
571617	17	160
571719	19	175

SAE Hex Key Wrenches

ITEM NO.	Size Inch	Length mm
590503	1/20	50
590504	1/16	53
590605	5/64	56
590606	3/32	58
590607	7/64	60
590608	1/8	62
590709	9/64	65
590710	5/32	70
590812	3/16	75
590814	7/32	80
590916	1/4	85
591020	5/16	100
591124	3/8	110
591328	7/16	125
591432	1/2	140
591536	9/16	145
591540	5/8	150
591848	3/4	175

Metric Long Hex Key Wrenches

ITEM NO.	Size mm	Length mm
570915L	1.5	88
571020L	2	98
571125L	2.5	112
571230L	3	125
571335L	3.5	130
571440L	4	140
571545L	4.5	150
571650L	5	160
571760L	6	175
571870L	7	185
572080L	8	200
572190L	9	210
572210L	10	225
572411L	11	240
572512L	12	250
572613L	13	260
572814L	14	280
572916L	16	295
573117L	17	310
573219L	19	325

SAE Long Hex Key Wrenches

ITEM NO.	Size Inch	Length mm
590803L	1/20	85
590904L	1/16	88
591005L	5/64	98
591106L	3/32	110
591208L	1/8	125
591310L	5/32	130
591512L	3/16	150
591614L	7/32	160
591816L	1/4	175
592020L	5/16	200
592324L	3/8	225
592428L	7/16	240
592632L	1/2	260
592836L	9/16	280
593040L	5/8	295
593248L	3/4	325

HK-007MF 7pcs Metric Hex Key Wrench Folding Set

7 Hex Key
1.27 - 1.5 - 2 - 2.5 - 3 - 4 - 5mm



Slide Card 130g 144 Sets / 21 Kgs / 2.00 CUFT

HK-009SF 9pcs SAE Hex Key Wrench Folding Set

9 Hex Key
3/64 - 1/16 - 5/64 - 3/32 - 7/64 - 1/8 - 9/64 - 5/32 - 3/16"



Slide Card 130g 144 Sets / 21 Kgs / 2.00 CUFT

Hex Key Wrenches

HK-009M 9pcs Metric Hex Key Wrench Set

9 Hex Key (570515 ~ 571210)
1.5 - 2 - 2.5 - 3 - 4 - 5 - 6 - 8 - 10mm

Plastic Holder
310g 72 Sets / 23.5 Kgs / 1.88 CUFT



HK-009S 9pcs SAE Hex Key Wrench Set

9 Hex Key (590504 ~ 591124)
1/16 - 5/64 - 3/32 - 1/8 - 5/32 - 3/16 - 1/4 - 5/16 - 3/8"

Plastic Holder
300g 72 Sets / 22.5 Kgs / 1.88 CUFT



HK-010M 10pcs Metric Hex Key Wrench Set

10 Hex Key (570515 ~ 571210)
1.5 - 2 - 2.5 - 3 - 4 - 5 - 5.5 - 6 - 8 - 10mm

Plastic Holder
310g 72 Sets / 23.5 Kgs / 1.44 CUFT



HK-010S 10pcs SAE Hex Key Wrench Set

10 Hex Key (590504 ~ 591124)
1/16 - 5/64 - 3/32 - 1/8 - 5/32 - 3/16 - 7/32 - 1/4 - 5/16 - 3/8"

Plastic Holder
300g 72 Sets / 22.5 Kgs / 1.44 CUFT



HK-025MS 25pcs Metric & SAE Hex Key Wrench Set

13 Metric Hex Key (570515 ~ 571210)
1.5 - 2 - 2.5 - 3 - 4 - 4.5 - 5 - 5.5 - 6 - 7 - 8 - 9 - 10mm

12 SAE Hex Key (590504 ~ 591124)
1/16 - 5/64 - 3/32 - 7/64 - 1/8 - 9/64 - 5/32 - 3/16 - 7/32 - 1/4 - 5/16 - 3/8"

835g 24 Sets / 21 Kgs / 0.92 CUFT

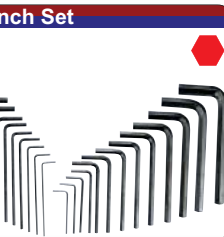

Wobble Hex Key Wrenches

Metric Wobble Hex Key Wrenches			SAE Wobble Hex Key Wrenches		
ITEM NO.	Size mm	Length mm	ITEM NO.	Size Inch	Length mm
570915B	1.5	88	590904B	1/16	88
571020B	2	98	591005B	5/64	98
571125B	2.5	112	591106B	3/32	110
571230B	3	125	591208B	1/8	125
571335B	3.5	130	591310B	5/32	130
571440B	4	140	591512B	3/16	150
571545B	4.5	150	591614B	7/32	160
571650B	5	160	591816B	1/4	175
571760B	6	175	592020B	5/16	200
571870B	7	185	592324B	3/8	225
572080B	8	200			
572190B	9	210			
572210B	10	225			

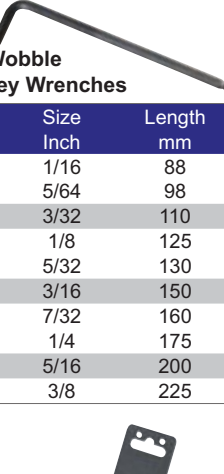

HK-009MB 9pcs Metric Wobble Hex Key Wrench Set

9 Wobble Hex Key (570915B ~ 572210B)
1.5 - 2 - 2.5 - 3 - 4 - 5 - 6 - 8 - 10mm

Plastic Holder
485g 36 Sets / 19 Kgs / 1.70 CUFT



HK-009SB 9pcs SAE Wobble Hex Key Wrench Set

9 Wobble Hex Key (590904B ~ 592324B)
1/16 - 5/64 - 3/32 - 1/8 - 5/32 - 3/16 - 1/4 - 5/16 - 3/8"

Plastic Holder
485g 36 Sets / 19 Kgs / 1.70 CUFT



Star Key Wrenches

Star Key Wrenches			Tamperproof Star Key Wrenches		
ITEM NO.	Size	Length mm	ITEM NO.	Size Inch	Length mm
580506	T-6	42	580807T	T-7	75
580507	T-7	48	580808T	T-8	77
580508	T-8	48	580809T	T-9	80
580509	T-9	48	580910T	T-10	85
580510	T-10	51	580915T	T-15	90
580615	T-15	54	581020T	T-20	95
580620	T-20	57	581025T	T-25	100
580625	T-25	60	581127T	T-27	105
580627	T-27	63	581230T	T-30	115
580730	T-30	70	581240T	T-40	125
580840	T-40	76	581345T	T-45	130
580845	T-45	82	581550T	T-50	150
580950	T-50	94	581755T	T-55	170
581055	T-55	108	581960T	T-60	190
581260	T-60	120	582270T	T-70	220
581470	T-70	138			

SK-010T 10pcs Tamperproof Star Key Wrench Set

10 Tamperproof Star Key (580809T ~ 581550T)
T9 - 10 - 15 - 20 - 25 - 27 - 30 - 40 - 45 - 50

Plastic Holder
480g 36 Sets / 19.5 Kgs / 1.80 CUFT



Triple Square Key Wrenches

ITEM NO.	Size	Length mm
582705M	M5	72
582806M	M6	80
582908M	M8	90
583010M	M10	100
583112M	M12	112
583214M	M14	125
583416M	M16	140

HK-007TS 7pcs Triple Square Key Wrench Set

7 Triple Square Key (582705M ~ 583416M)
M5 - 6 - 8 - 10 - 12 - 14 - 16

Plastic Holder
920g 20 Sets / 19.5 Kgs / 1.07 CUFT

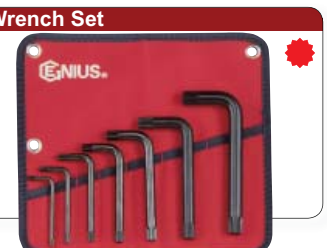

Wrenches

Adjustable Wrenches

Adjustable Wrenches

ITEM NO.	Jaw Capacity mm	Length mm
780128	13	100
780192	19	150
780256	24	200
780320	28	250
780384	33	300
780480	42	380
780576	52	450



Pipe Wrenches

Heavy Duty Pipe Wrenches

ITEM NO.	Length mm (Inch)	Weight g
782200	200mm (8")	470
782250	250mm (10")	840
782300	300mm (12")	1100
782350	350mm (14")	1420
782460	460mm (18")	2440
782610	610mm (24")	4330
782910	910mm (36")	8000
783220	1220mm (48")	14000



Aluminum Pipe Wrenches

ITEM NO.	Length mm (Inch)	Weight g
784350	350mm (14")	880
784460	460mm (18")	1460
784610	610mm (24")	2440
784910	910mm (36")	4500
785220	1220mm (48")	8000



Torque Wrenches

1/4" Dr. Torque Wrenches

ITEM NO.	Capacity	Length mm
280030N	6~30 Nm	350
280250L	40~250 in.lb.	350

3/8" Dr. Torque Wrenches

ITEM NO.	Capacity	Length mm
380030N	6~30 Nm	350
380110N	19~110 Nm	385
380250L	40~250 in.lb.	350
380080F	15~80 ft.lb.	385

1/2" Dr. Torque Wrenches

ITEM NO.	Capacity	Length mm
480210N	40~210 Nm	535
480350N	70~350 Nm	645
480150F	30~150 ft.lb.	535
480250F	50~250 ft.lb.	645

3/4" Dr. Torque Wrenches

ITEM NO.	Capacity	Length mm
680500N	100~500 Nm	865
680700N	140~700 Nm	1092
680980N	140~980 Nm	1230
680300F	50~300 ft.lb.	865
680600F	100~600 ft.lb.	1092
680700F	100~700 ft.lb.	1230

1" Dr. Torque Wrenches

ITEM NO.	Capacity	Length mm
880980N	140~980 Nm	1230
880700F	100~700 ft.lb.	1230



- Set the desired torque before using the torque wrenches.
- When torque is applied, a click can be heard and felt when the desired torque is reached. This feature is more evident in the higher range of the scale.
- Graduated scales in SAE and Metric measurement systems are etched on the shaft. They are horizontal on the shaft and vertical on the handle.
- Continuous-use design offers the user an excellent precision tool for specific torques.
- All parts are made of steel and tempered to prevent wear. Outer parts have a nickel-chromium coating to prevent oxidation.
- The lever on the ratchet head can be positioned for ratchet action to the left or to the right.
- Double armature: exclusive internal design minimizes the amount of force required, reduces friction, lengthens tool life and permits precise, long-lasting calibration.
- Meets or exceeds the requirements of ANSI & DIN standards with accuracy of $\pm 4\%$ in clockwise direction.

Torque Multipliers

ITEM NO.	Drive Inch	Capacity	Length mm
401000	Input: 1/2" Output: 3/4"	MAX: 460 Nm/340 ft.lb. MAX: 1400 Nm/1000 ft.lb. Output/Input = 3/1	420
602000	Input: 3/4" Output: 1"	MAX: 900 Nm/650 ft.lb. MAX: 2700 Nm/2000 ft.lb. Output/Input = 3/1	500



Pliers w/ Cushion Grips



A Diagonal Cutting Pliers

ITEM NO.	Length mm (Inch)
550507	130mm (5")
550607	150mm (6")
550707	180mm (7")

B Chain Nose Pliers w/ Cutter

ITEM NO.	Length mm (Inch)
550504	130mm (5")
550604	150mm (6")
550804	200mm (8")



C Heavy Duty Diagonal Cutting Pliers

ITEM NO.	Length mm (Inch)
550708	180mm (7")
550808	200mm (8")

D Needle Nose Pliers

ITEM NO.	Length mm (Inch)
550606	150mm (6")



E Duckbill Pliers

ITEM NO.	Length mm (Inch)
550805	200mm (8")

F Combination (Slip Joint) Pliers

ITEM NO.	Length mm (Inch)
550609	150mm (6")
550809	200mm (8")
551009	250mm (10")



G Tongue & Groove Pliers

ITEM NO.	Length mm (Inch)
550611	150mm (6")
550811	200mm (8")
551011	250mm (10")
551211	300mm (12")
551611	400mm (16")

H Side Cutter Pliers

ITEM NO.	Length mm (Inch)
550712	180mm (7")
550812	200mm (8")



I Hose Clamp Pliers

ITEM NO.	Length mm (Inch)
550810	200mm (8")

J End Cutter Pliers

ITEM NO.	Length mm (Inch)
550613	150mm (6")

Retaining Ring Pliers

ITEM NO.	Type	Diameter Tip	Angle Tip	Length mm (Inch)
a. 550750	External	1.8mm	Straight	180mm (7")
b. 550751	Internal	1.8mm	Straight	180mm (7")
c. 550752	External	1.8mm	90°	165mm (6-1/2")
d. 550753	Internal	1.8mm	90°	165mm (6-1/2")

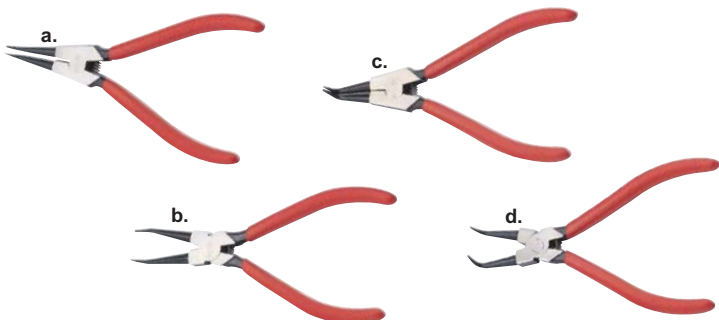

Pliers w/ Plastic Handle



A Bent Nose Pliers

ITEM NO.	Length mm (Inch)
550614D	150mm (6")
550814D	200mm (8")

B Chain Nose Pliers w/ Cutter

ITEM NO.	Length mm (Inch)
550604D	150mm (6")
550804D	200mm (8")



C Side Cutter Pliers

ITEM NO.	Length mm (Inch)
550612D	150mm (6")
550712D	180mm (7")
550812D	200mm (8")

D Diagonal Cutting Pliers

ITEM NO.	Length mm (Inch)
550607D	150mm (6")



E Heavy Duty Diagonal Cutting Pliers

ITEM NO.	Length mm (Inch)
550708D	180mm (7")
550808D	200mm (8")

F Water Pump Pliers w/ Cushion Grip

ITEM NO.	Length mm (Inch)
551011D	250mm (10")

CP-5704 4pcs Pliers Set

- 1 8" Side Cutter Pliers (550812)
- 1 7" Diagonal Cutting Pliers (550707)
- 1 8" Chain Nose Pliers w/ Cutter (550804)
- 1 8" Combination Slip Joint Pliers (550809)



1/3 Tray 1630g 5 Sets / 9.5 Kgs / 0.93 CUFT

CP-5804 4pcs General Purpose Pliers Set

- 1 6" Chain Nose Pliers w/ Cutter (550604D)
- 1 6" Diagonal Cutting Pliers (550607D)
- 1 7" Side Cutter Pliers (550712D)
- 1 10" Water Pump Pliers (551011D)



1/3 Tray 1590g 5 Sets / 9 Kgs / 0.93 CUFT

CP-5312 12pcs Locking Pliers Set

- 3 Curved Jaw Locking Pliers w/ Cutter: 5" - 7" - 10"
- 2 Long Nose Locking Pliers w/ Cutter: 6" - 9"
- 2 Straight Jaw Locking Pliers: 7" - 10"
- 2 Locking "C" Clamps: 6" - 11"
- 1 Water Pump Pliers: 10"
- 1 Chain Nose Pliers w/ Cutter: 8"
- 1 Heavy Duty Diagonal Cutting Pliers: 8"



2/3 Tray 5400g 5 Sets / 28 Kgs / 1.58 CUFT

RP-5504 4pcs Retaining Ring Pliers Set

- 1 Straight Nose, External (550750)
- 1 Straight Nose, Internal (550751)
- 1 90° Bent Nose, External (550752)
- 1 90° Bent Nose, Internal (550753)

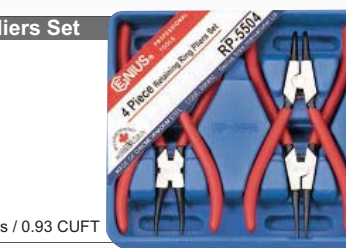

1/6 Tray 830g 10 Sets / 10 Kgs / 0.93 CUFT

Pliers & Hammers

Locking Pliers



Straight Jaw

A Locking Pliers

ITEM NO.	Length mm (Inch)
530307RA	180mm (7")
530310RA	250mm (10")



Curved Jaw

B Locking Pliers w/ Cutter

ITEM NO.	Length mm (Inch)
530307A	180mm (7")
530310A	250mm (10")



Large Jaw

C Locking Pliers

ITEM NO.	Length mm (Inch)
534312LJ	250mm (10")



Long Nose

D Locking Pliers w/ Cutter

ITEM NO.	Length mm (Inch)
531306LN	150mm (6")
531309LN	230mm (9")



E Sheet Metal Pliers

ITEM NO.	Length mm (Inch)
532308SM	200mm (8")



F Locking Welding Clamp

ITEM NO.	Length mm (Inch)
533309LW	230mm (9")

G Locking "C" Clamps w/ Swivel Pads

ITEM NO.	Length mm (Inch)
530311AR	280mm (11")



Aviation Snips

Straight Tip Aviation Snips

ITEM NO.	Description	Length mm
a. 511001L	Left Cut Aviation Snip. Cuts straight and tight curves to the left.	250
b. 511002R	Right Cut Aviation Snip. Cuts straight and tight curves to the right.	250
c. 511003S	Straight Cut Aviation Snip. Cuts straight and wide curves to the left and right.	250

Offset Tip Aviation Snips

ITEM NO.	Description	Length mm
d. 511004L	Offset-Left Cut Aviation Snip. Cuts straight and tight left curves.	250
e. 511005R	Offset-Right Cut Aviation Snip. Cuts straight and tight right curves.	250

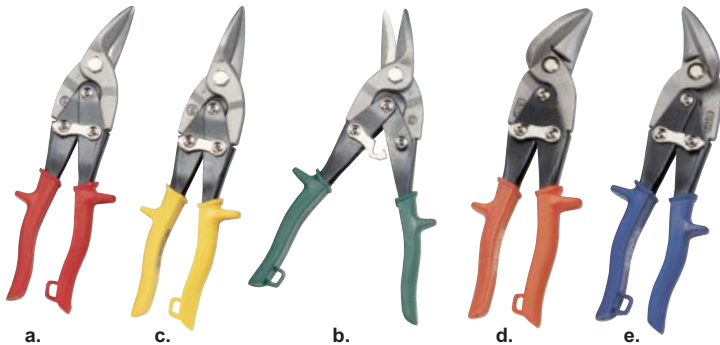

Hammers



A Claw Hammer

ITEM NO.	Head Weight	Length mm
590116	1 lbs./454g	330



B Ball Peen Hammers

ITEM NO.	Head Weight	Length mm
590208	1/2 lbs./227g	280
590212	3/4 lbs./340g	305
590216	1 lbs./454g	330
590224	1-1/2 lbs./681g	350
590232	2 lbs./908g	380



C Drilling Hammers

ITEM NO.	Head Weight	Length mm
590348	2-1/2 lbs./1135g	270
590364	4 lbs./1816g	270



D Rubber Mallet

ITEM NO.	Head Weight	Length mm
590524	1-1/2 lbs./680g	330

Punches & Chisels



SAE Pin Punches

ITEM NO.	Size Inch	Length mm
566102	1/16	100
566103	3/32	100
566124	1/8	125
566145	5/32	140
566166	3/16	160
566206	3/16	200
566168	1/4	160
566208	1/4	200
566210	5/16	200



Metric Pin Punches

ITEM NO.	Size mm	Length mm
565102	2	100
565123	3	125
565144	4	140
565165	5	160
565205	5	200
565166	6	160
565206	6	200
565208	8	200



Flat Chisels

ITEM NO.	Size mm	Length mm
561206	6	125
561410	10	140
561612	12	150
561614	14	150
561616	16	160
562019	19	200
563019	19	300
562022	22	200
563022	22	300
562025	25	200



Long Taper Line Up Punches

ITEM NO.	Size mm	Length mm
564202	2	200
564203	3	200
564254	4	250
564255	5	250
564286	6	280



Center Punches

ITEM NO.	Size mm	Length mm
563100	3	100
563110	4	110
563125	5	125
563140	6	140
563160	8	160



Oval Bearing Punches

ITEM NO.	Size mm / Inch	Length mm
565311	11x6 (7/16x1/8)	150
565313	13x7 (1/2x7/16)	250
565315	15x8 (9/16x1/2)	350
565317	17x9 (5/8x11/32)	500

Punch & Chisel Sets

PC-566MP 6pcs Metric Pin Punch Set

6 Metric Pin Punch (565102 ~ 565208)
2 - 3 - 4 - 5 - 6 - 8mm

500g 10 Sets / 6 Kgs / 0.62 CUFT



PC-577SP 7pcs SAE Pin Punch Set

7 SAE Pin Punch (566102 ~ 566210)
1/16 - 3/32 - 1/8 - 5/32 - 3/16 - 1/4 - 5/16"

520g 10 Sets / 6.5 Kgs / 0.62 CUFT



PC-567F 7pcs Flat Chisel Set

7 Flat Chisel (561206 ~ 562022)
6 - 10 - 12 - 14 - 16 - 19 - 22mm

1250g 10 Sets / 13.5 Kgs / 0.62 CUFT



PC-565LU 5pcs Long Taper Line Up Punch Set

5 Long Taper Line Up Punch (564202 ~ 564286)
2 - 3 - 4 - 5 - 6mm

680g 20 Sets / 15 Kgs / 0.70 CUFT



PC-575C 5pcs Center Punch Set

5 Center Punch (563100 ~ 563160)
3 - 4 - 5 - 6 - 8mm

620g 10 Sets / 7.5 Kgs / 0.62 CUFT



PC-BP4 4pcs Oval Bearing Punch Set

4 Oval Bearing Punch (565311 ~ 565317)
11x6mm (7/16"x16/64") - 13x7mm (1/2"x17/64") - 15x8mm (9/16"x19/64") - 17x9mm (5/8"x11/32")

1500g 15 Sets / 23.5 Kgs / 0.82 CUFT



Punch & Chisel Sets

PC-514M 14pcs Metric Punch & Chisel Set

5 Pin Punch (565102 ~ 565166)
2 - 3 - 4 - 5 - 6mm

5 Flat Chisel (561206 ~ 561616)
6 - 10 - 12 - 14 - 16mm

2 Long Taper Line Up Punch: (564204 ~ 564255)
3 - 5mm

2 Center Punch: (563100 ~ 563125)
3 - 5mm

1140g 6 Sets / 8 Kgs / 0.45 CUFT



PC-514S 14pcs SAE Punch & Chisel Set

5 Pin Punch (566103 ~ 566168)
3/32 - 1/8 - 5/32 - 3/16 - 1/4"

5 Flat Chisel (561206 ~ 561616)
6 - 10 - 12 - 14 - 16mm

2 Long Taper Line Up Punch (564204 ~ 564255)
3 - 5mm

2 Center Punch (563100 ~ 563125)
3 - 5mm

1140g 6 Sets / 8 Kgs / 0.45 CUFT



Pry Bars & Sets

Pry Bars

ITEM NO.	Length mm (Inch)
560008	200mm (8")
560012	300mm (12")
560018	455mm (18")
560024	610mm (24")

Pry Bar

ITEM NO.	Length mm (Inch)
560036	910mm (36")

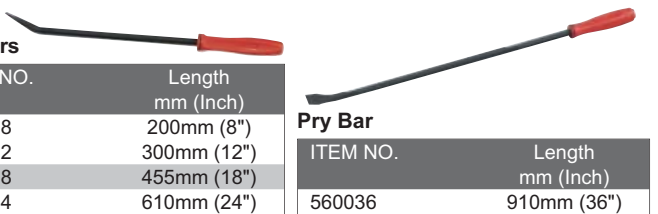

Close Quarters Bar

ITEM NO.	Length mm (Inch)
015618	455mm (18")

Pinch Bar

ITEM NO.	Length mm (Inch)
015638	965mm (38")

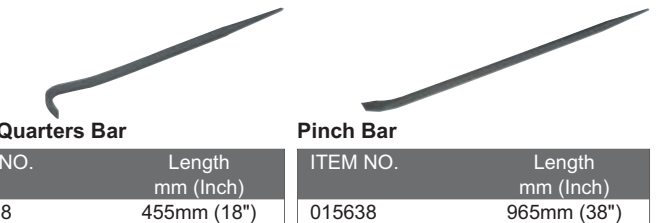

PB-5094 4pcs Pry Bar Set

4 Pry Bar (560008 ~ 560024)
200mm (8") - 300mm (12") - 455mm (18") - 610mm (24")

1670g 12 Sets / 21 Kgs / 1.63 CUFT



Wheel Torque Tools

Wheel Torque Tools

Torque Extension Bars

ITEM NO.	Color	Square Drive	Torque Limit	Length mm
487065	Green	1/2"	65 ft.lb. (90 Nm)	180
487075	Black	1/2"	75 ft.lb. (100 Nm)	180
487080	Yellow	1/2"	80 ft.lb. (110 Nm)	180
487090	Red	1/2"	90 ft.lb. (120 Nm)	180
487100	Blue	1/2"	100 ft.lb. (135 Nm)	180
487110	Orange	1/2"	110 ft.lb. (150 Nm)	180
487120	Grey	1/2"	120 ft.lb. (160 Nm)	180
487130	Brown	1/2"	130 ft.lb. (175 Nm)	180
487140	White	1/2"	140 ft.lb. (190 Nm)	180
487150	Light Blue	1/2"	150 ft.lb. (200 Nm)	180
687175	Black	3/4"	175 ft.lb. (240 Nm)	180
687250	Black	3/4"	250 ft.lb. (340 Nm)	180
687350	Black	3/4"	350 ft.lb. (475 Nm)	180
687475	Black	3/4"	475 ft.lb. (645 Nm)	180
887250	Black	1"	250 ft.lb. (340 Nm)	254
887350	Black	1"	350 ft.lb. (475 Nm)	254
887475	Black	1"	475 ft.lb. (645 Nm)	254
887650	Black	1"	650 ft.lb. (880 Nm)	254

TO-405EXT 5pcs 1/2" Dr. Torque Extension Bar Set

- 5 1/2" Torque Extension Bar
- 487065 65 ft.lb. (90Nm)
 - 487080 80 ft.lb. (110Nm)
 - 487100 100 ft.lb. (135Nm)
 - 487120 120 ft.lb. (160Nm)
 - 487140 140 ft.lb. (190Nm)

1500g 8 Sets / 13 Kgs / 0.88 CUFT



TO-410EXT 10pcs 1/2" Dr. Torque Extension Bar Set

- 10 1/2" Torque Extension Bar
- 487065 65 ft.lb. (90Nm)
 - 487075 75 ft.lb. (100Nm)
 - 487080 80 ft.lb. (110Nm)
 - 487090 90 ft.lb. (120Nm)
 - 487100 100 ft.lb. (135Nm)
 - 487110 110 ft.lb. (150Nm)
 - 487120 120 ft.lb. (160Nm)
 - 487130 130 ft.lb. (175Nm)
 - 487140 140 ft.lb. (190Nm)
 - 487150 150 ft.lb. (200Nm)

3250g 4 Sets / 14 Kgs / 1.07 CUFT



Torque Extension Bars:

- Torque Extensions are designed for 1/2" Dr. impact wrench rated 380-420 ft.lb.; 3/4" Dr. impact wrench rated 750 ft.lb.; 1" Dr. impact wrench rated 1,500 ft.lb.
- The various drive sizes and torque limits allow use of any impact socket with a torque extension to match the different lug nut sizes found on vehicles
- Helps prevent over-torquing of wheel nuts and can minimize wheel distortion.
- The unique design allows the length and diameter of the torque extension shaft to flex with each blow of the impact wrench once the specified torque is reached.
- Accurate to within +/- 4%.

Wheel Torque Tools

1/2" Dr. Thin Wall Deep Impact Socket w/ Plastic Sleeves

ITEM NO.	Color	Description Size	Length mm
448517W	Yellow	17mm - With Yellow Plastic Sleeve	86
448519W	Red	19mm (3/4") - With Red Plastic Sleeve	86
448521W	Blue	21mm - With Orange Plastic Sleeve	86
468526W	Orange	13/16" - With Blue Plastic Sleeve	86

Features:

- Thin Wall Deep Impact Sockets are designed to allow easy access to recessed wheel nuts where space is limited.
- Changeable plastic sleeves.
- With additional outside plastic sleeve to protect the rims when tightening the wheel nuts/screws.
- Special design for American, European and Japanese cars.

CW-403M 3pcs 1/2" Dr. Metric Car Wheel Thin Wall Impact Socket

- 3 1/2" Dr. 6pt. Metric Thin Wall
- 448517W 17mm - w/ Yellow Plastic Sleeve
 - 448519W 19mm - w/ Red Plastic Sleeve
 - 448521W 21mm - w/ Orange Plastic Sleeve

800g 20 Sets / 17 Kgs / 1.00 CUFT



CW-404MS 4pcs 1/2" Dr. Metric & SAE Thin Wall Impact Socket Set

- 3 1/2" Dr. 6pt. Metric Thin Wall
- 448517W 17mm - w/ Yellow Plastic Sleeve
 - 448519W 19mm - w/ Red Plastic Sleeve
 - 448521W 21mm - w/ Orange Plastic Sleeve
- 1 1/2" Dr. 6pt. SAE Thin Wall
- 468526W 13/16" - w/ Blue Plastic Sleeve

1170g 10 Sets / 13 Kgs / 0.93 CUFT



CW-406M 6pcs 1/2" Dr. Metric Car Wheel COLOUR MATCH® Set

- 3 1/2" Dr. 6pt. Metric Thin Wall
- 448517W 17mm - w/ Yellow Plastic Sleeve
 - 448519W 19mm - w/ Red Plastic Sleeve
 - 448521W 21mm - w/ Orange Plastic Sleeve
- 3 1/2" Torque Extension Bar
- 487080 80 ft.lb. (110Nm)
 - 487090 90 ft.lb. (120Nm)
 - 487110 110 ft.lb. (150Nm)

1760g 5 Sets / 10 Kgs / 0.93 CUFT



CW-408MS 8pcs 1/2" Dr. Metric & SAE Metric COLOUR MATCH®

- 3 1/2" Dr. 6pt. Metric Thin Wall
- 448517W 17mm - w/ Yellow Plastic Sleeve
 - 448519W 19mm - w/ Red Plastic Sleeve
 - 448521W 21mm - w/ Orange Plastic Sleeve
- 1 1/2" Dr. 6pt. SAE Thin Wall
- 468526W 13/16" - w/ Blue Plastic Sleeve
- 4 1/2" Torque Extension Bar
- 487080 80 ft.lb. (110Nm)
 - 487090 90 ft.lb. (120Nm)
 - 487100 100 ft.lb. (135Nm)
 - 487110 110 ft.lb. (150Nm)

2170g 5 Sets / 12 Kgs / 0.93 CUFT

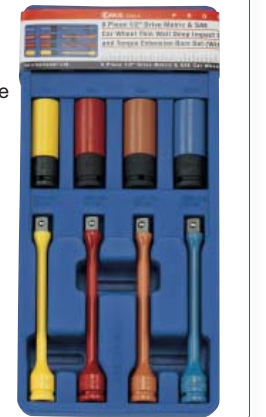









Wheel Torque Tools

Torque Sockets

ITEM NO.	Color	Square Drive	Wrench Size	Torque Limit	Length mm
417M055	Green	1/2"	17mm Hex	55 ft.lb. (75Nm)	206
417M080	Red	1/2"	17mm Hex	80 ft.lb. (108Nm)	206
419M065	Yellow	1/2"	19mm (3/4") Hex	65 ft.lb. (88Nm)	206
419M080	Blue	1/2"	19mm (3/4") Hex	80 ft.lb. (108Nm)	206
419M100	Grey	1/2"	19mm (3/4") Hex	100 ft.lb. (135Nm)	206
421M060	Black	1/2"	21mm Hex	60 ft.lb. (81Nm)	206
421M080	Orange	1/2"	21mm Hex	80 ft.lb. (108Nm)	206
421M147D	Dark Grey	1/2"	21mm Hex	147 ft.lb. (200Nm)	220
422M120D	White	1/2"	22mm Hex	120 ft.lb. (163Nm)	220
422M140D	Light Blue	1/2"	22mm Hex	140 ft.lb. (190Nm)	220
426S100	Brown	1/2"	13/16" Hex	100 ft.lb. (135Nm)	206
430S140D	Light Green	1/2"	15/16" Hex	140 ft.lb. (190Nm)	220
434S140D	Light Yellow	1/2"	1-1/16" Hex	140 ft.lb. (190Nm)	220

819M065	Yellow	1"	19mm (3/4") Hex	65 ft.lb. (88Nm)	305
824M450	Black	1"	24mm Hex	(350Nm)	305
827M450	Black	1"	27mm Hex	(450Nm)	305
830M550	Black	1"	30mm Hex	(550Nm)	305
832M600	Black	1"	32mm Hex	(600Nm)	305
832M650	Black	1"	32mm Hex	(650Nm)	305
833M600	Black	1"	33mm Hex	(600Nm)	305
833M650	Black	1"	33mm Hex	(650Nm)	305
836M650	Black	1"	36mm Hex	(650Nm)	305
841M400	Orange	1"	41mm (1-5/8") Hex	400 ft.lb. (542Nm)	305
841M650	Black	1"	41mm Hex	(650Nm)	305
834S200	White	1"	1-1/16" (27mm) Hex	200 ft.lb. (271Nm)	305
834S300	Light Blue	1"	1-1/16" (27mm) Hex	300 ft.lb. (407Nm)	305
840S250	Brown	1"	1-1/4" (32mm) Hex	250 ft.lb. (339Nm)	305
838S300	Yellow	1"	1-3/16" (30mm) Hex	300 ft.lb. (407Nm)	305
838S400	Red	1"	1-3/16" (30mm) Hex	400 ft.lb. (542Nm)	305
842S325	Dark Red	1"	1-5/16" Hex	325 ft.lb. (441Nm)	305
842S475	Green	1"	1-5/16" Hex	475 ft.lb. (644Nm)	305
848S475	Grey	1"	1-1/2" (38mm) Hex	475 ft.lb. (644Nm)	305
848S525	Blue	1"	1-1/2" (38mm) Hex	525 ft.lb. (712Nm)	305
826S475	Black	1"	13/16" Square	475 ft.lb. (644Nm)	305









TO-407M 7pcs 1/2" Dr. Metric Car Wheel Torque Socket Set

- 7  1/2" Dr. Torque Socket
- 417M055  17mm (55 ft.lb./75Nm)
 - 417M080  17mm (80 ft.lb./108Nm)
 - 419M065  19mm (65 ft.lb./88Nm)
 - 419M080  19mm (80 ft.lb./108Nm)
 - 419M100  19mm (100 ft.lb./135Nm)
 - 421M060  21mm (60 ft.lb./81Nm)
 - 421M080  21mm (80 ft.lb./108Nm)



 3000g  5 Sets / 16 Kgs / 1.62 CUFT

TO-408S 8pcs 1/2" Dr. Metric & SAE Car Wheel Torque Socket Set













- 8  1/2" Dr. Torque Socket
- 417M055  17mm (55 ft.lb./75Nm)
 - 417M080  17mm (80 ft.lb./108Nm)
 - 419M065  19mm (65 ft.lb./88Nm)
 - 419M080  19mm (80 ft.lb./108Nm)
 - 419M100  19mm (100 ft.lb./135Nm)
 - 421M060  21mm (60 ft.lb./81Nm)
 - 421M080  21mm (80 ft.lb./108Nm)
 - 426S100  13/16" (100 ft.lb./135Nm)



 3500g  5 Sets / 18.5 Kgs / 1.65 CUFT

Wheel Torque Tools















TO-410M 10pcs 1/2" Dr. Metric Car Wheel Torque Socket Set

- 3  1/2" Dr. 6pt. Metric Thin Wall
- 448517W  17mm - w/ Plastic Sleeve
 - 448519W  19mm - w/ Plastic Sleeve
 - 448521W  21mm - w/ Plastic Sleeve
- 7  1/2" Dr. Torque Socket
- 417M055  17mm (55 ft.lb./75Nm)
 - 417M080  17mm (80 ft.lb./108Nm)
 - 419M065  19mm (65 ft.lb./88Nm)
 - 419M080  19mm (80 ft.lb./108Nm)
 - 419M100  19mm (100 ft.lb./135Nm)
 - 421M060  21mm (60 ft.lb./81Nm)
 - 421M080  21mm (80 ft.lb./108Nm)



 3750g  4 Sets / 16 Kgs / 1.65 CUFT

TO-412MS 12pcs 1/2" Dr. Metric & SAE Car Wheel Torque Socket

- 3  1/2" Dr. 6pt. Metric Thin Wall
- 448517W  17mm - w/ Plastic Sleeve
 - 448519W  19mm - w/ Plastic Sleeve
 - 448521W  21mm - w/ Plastic Sleeve
- 1  1/2" Dr. 6pt. SAE Thin Wall
- 468526W  13/16" - w/ Plastic Sleeve
- 8  1/2" Dr. Torque Socket
- 417M055  17mm (55 ft.lb./75Nm)
 - 417M080  17mm (80 ft.lb./108Nm)
 - 419M065  19mm (65 ft.lb./88Nm)
 - 419M080  19mm (80 ft.lb./108Nm)
 - 419M100  19mm (100 ft.lb./135Nm)
 - 421M060  21mm (60 ft.lb./81Nm)
 - 421M080  21mm (80 ft.lb./108Nm)
 - 426S100  13/16" (100 ft.lb./135Nm)



 4375g  4 Sets / 18.5 Kgs / 1.65 CUFT

Disc Brake Calipers

AT-08 11pcs Disc Brake Caliper Tool Set

- 7 Rear Disc Brake Caliper Adapters:
 - 32mm(1 1/4") -
 - 42mm(1 5/8") Long Pin -
 - 42mm(1 5/8") Short Pin -
 - 1 7/8"(43mm) - 2"(51mm) -
 - 2 1/8"(54mm) - 2 1/2"(63mm)
- 1 Front Disc Brake Caliper Adapters:
 - 55mm(2 3/16")
- 3 Accessory:
 - Plate - 3/8" Square Dr. Adapter -
 - Pusher Screw Assembly



2100g 10 Sets / 22 Kgs / 2.20 CUFT

- Jack up the car and support on axle stands, Then remove the relevant road wheel
- Remove the caliper from its carrier and take out the brake pads
- Fit the main body of the wind back tool into the caliper, turn the main thrust bolt clockwise to compensate for the distance between the position and caliper body
- Select the correct adapter and fit it to the end of the main thrust bolt, continue rotating into the mating recesses in the piston
- Turn the thrust bolt to wild the caliper piston back into its housing
- Fit the new break pads and bolt the caliper back into the carrier

AT-BC08 11pcs Brake Piston Wind Back Set

- 1 Handle (R) 1 Plate
- 9 Adapters:
 - 32mm(1 1/4") (2 Pins \square = 5mm)
 - 36mm(1 7/16") (2 Pins \square = 4mm)
 - 36mm(1 7/16") (2 Pins \square = 6.35mm)
 - 42mm(1 5/8") (2 Pins \square = 6mm)
 - 46mm(1 13/16") (2 Pins \square = 5mm)
 - 36mm(1 7/16") (1 Sq. Pin \square = 8mm)
 - 46mm(1 13/16") (1 Sq. Pin \square = 8mm)
 - 48mm(1 7/8") (2 Sq. Pins \square = 11mm)
 - 55mm(2-3/16")



2000g 4 Sets / 9 Kgs / 0.85 CUFT

Designed for most:

Alfa - Audi - BMW - Fiat - Ford - GM - Honda - Jaguar - Mercedes - Mazda - Nissan - Peugeot - Rover - Saab - Toyota - VW

AT-BC18 18pcs Master Universal Caliper Wind Back Set

- 2 Handle (L) & (R) 1 Plate
- 15 Adapters:
 - 32mm(1 1/4") (12mm Male Hex)
 - 30mm(1 3/16") (2 Pins \square = 4mm)
 - 32mm(1 1/4") (2 Pins \square = 4mm)
 - 32mm(1 1/4") (2 Pins \square = 5.5mm)
 - 32mm(1 1/4") (2 Short Pins \square = 5mm)
 - 42mm(1 5/8") (2 Short Pins \square = 6mm)
 - 42mm(1 5/8") (2 Long Pins \square = 6mm)
 - 42mm(1 5/8") (4 Pins \square = 5mm)
 - 47mm(1 7/8") (1 Pin \square = 5.5mm)
 - 51mm(2") (1 Long 2 Short Pin \square = 6mm)
 - 54mm(2 1/8") (1 Pin \square = 5.5mm)
 - 54mm(2 1/8") (2 Pins \square = 8mm)
 - 63mm(2 1/2") (1 Pin \square = 5.5mm)
 - 55mm(2-3/16")
 - 3/8" Square Dr. (2 Pins \square = 6mm)



2500g 4 Sets / 11 Kgs / 1.07 CUFT

Designed for most:

Audi - BMW - Citroen - Fiat - Ford - GM - Honda - Isuzu - Jaguar - Mercedes - Mazda - Nissan - Peugeot - Rover - Saab - Subaru - Toyota - Volvo - VW

Inner Tie Rod

AT-4808 8pcs Inner Tie Rod Tool Set

- 7 Open Jaw Drivers:
 - 14 - 17 - 33.6mm
 - 1 3/16 - 1 1/4 - 1 5/16 - 1 7/16"
- 1 Long Socket

2400g 6 Sets / 15.5 Kgs / 1.35 CUFT



These tools are specially designed for the inner tie rods that are inaccessible to adjust. The long socket can be easily used with seven open-jaw drivers, size 1-3/16", 1-1/4", 1-5/16", 1-7/16", 14mm, 17mm and 33.6mm, to most application. The inner tie rod can be easily removed and installed by slipping the long socket over the tie rod end and connecting it to the open-jaw driver.

Valve Spring Compressor

AT-09 9pcs Valve Spring Compressor Set

- 1 "C" Clamp: 250mmL (10"L)
- 5 Driving Adapters:
 - 16 - 19 - 23 - 25 - 30mm
- 2 Pressure Screws:
 - 70 - 110mmL

2000g 4 Sets / 9 Kgs / 1.00 CUFT



These tools are designed to compress and release valve springs. After removal of collects, pantograph-type levers ensure a consistent coaxial contact with the valve. They work efficiently on all automobiles, trucks and tractor motors.

Ball Joints

AT-0914 14pcs Ball Joint Adapter Set

Description	O.D.	I.D.	Length
9 Receiving Tube	2 1/4"	2"	2"
Receiving Tube	2 1/2"	2 1/4"	1 1/2"
Receiving Tube	2 1/4"	1 7/8"	7/16"
Receiving Tube	2 1/2"	2 1/4"	3/4"
Receiving Tube	2 1/2"	2 1/4"	2 3/4"
Receiving Tube	3"	2 3/4"	2 1/4"
Receiving Tube	2 3/4"	2 7/16"	2 1/4"
Receiving Tube	2 7/8"	2 5/8"	2 7/8"
Receiving Tube	2 7/16"	2 3/16"	3 3/16"
2 Installing Tube	2"	1 3/4"	2 5/16"
Installing Tube	2"	1 3/4"	3"
1 Receiving Cup	2 1/8"	1 3/4"	1/2"
1 Plug	7/8"		
1 Remover/Installer	1 7/16"	3/4"	1"

5340g 3 Sets / 17 Kgs / 1.60 CUFT



- A complete ball joint adapter set
- Includes all the receive tubes and removing/installing adapters needed to work on most GM, Ford and Dodge two and four-wheel drive pickups, vans and sport utility vehicles through 2002. Application chart included
- Works on press-fit upper and lower ball joints
- Set also includes a live center forcing screw plug

AT-7207 7pcs Ball Joint Removal & Installing Set

- 3 Receiving Tubes
- 1 Forcing Screw
- 1 Removing Adapter
- 1 Installing Adapter
- 1 C-Frame

7000g 2 Sets / 15 Kgs / 0.92 CUFT



Belt Tensioning Wrenches

AT-BW08 8pcs Belt Tensioning Wrench Set

- 5 Sockets: 13 - 14 - 15 - 16 - 18mm
- 2 Adapters: 3/8" & 1/2"Dr.
- 1 Handle:
15mm Hex Ratcheting Wrench



1050g 20 Sets / 22.4 Kgs / 2.10 CUFT

AT-BW15 15pcs Belt Tensioning Wrench Set

- 9 Socket: 8 - 12 - 13 - 14 - 15 - 16 - 17 - 18mm (6pt.)
Socket: 24mm (12pt.)
- 2 Adapters: 3/8" & 1/2"Dr.
- 3 Bit Adapter: 1/4"x5/16" - 5/16"x5/16" - 10mmx5/16" Hex Shank
- 1 Handle:
15mm Hex Ratcheting Wrench

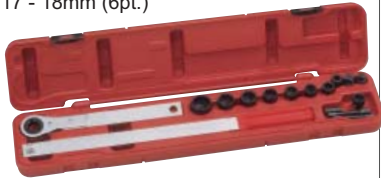

1680g 12 Sets / 12.1 Kgs / 1.80 CUFT

Oil Filter Wrenches

Three-Legged Oil Filter Wrench

ITEM NO.	Capacity mm (Inch)
AT-B01	65~110mm (2-1/2 ~ 4-5/16")

- Fits 3/8" Dr. ratchet
- Grooved legs generate more gripping power



Heavy Duty Oil Filter Pliers

ITEM NO.	Capacity mm (Inch)	Length mm (Inch)
AT-OF10	60~90mm (2-3/8 ~ 3-1/2")	250 (10")
AT-OF12	50 ~ 115mm (2" ~ 4-1/2")	300 (12")

- 3 Position Adjustable



Swivel Handle Oil Filter Wrenches

ITEM NO.	Diameter Capacity mm (Inch)
AT-BOF2	60~73mm (2-3/8 ~ 2-7/8")
AT-BOF3	73~85mm (2-7/8 ~ 3-3/8")
AT-BOF4	85~95mm (3-3/8 ~ 3-3/4")
AT-BOF5	95~100mm (3-3/4 ~ 4-3/8")



Extractors

AT-EX6 6pcs Screw Extractor Set

- 6 Screw Extractors
 - No.1 3~6mm (1/8~1/4") -
 - No.2 6~8mm (1/4~5/16") -
 - No.3 8~11mm (5/16~7/16") -
 - No.4 11~14mm (7/16~9/16") -
 - No.5 14~19mm (9/16~3/4") -
 - No.6 19~25mm (3/4~1")



Plastic Case
250g 40 Sets / 11 Kgs / 0.71 CUFT

Hose Clamp Drivers

ITEM NO.	Size mm	Length mm
596+0146	6	280
596+0147	7	280
596+0148	8	280
596+0150	10	280



6 pt.

Heater Hose Clamp Pliers

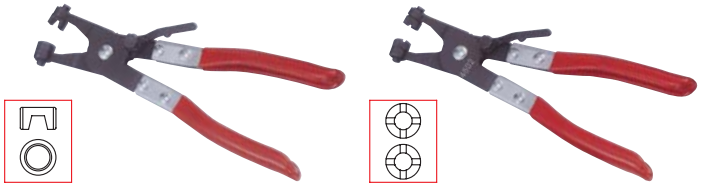

ITEM NO.	Length mm (Inch)
AT-HC10	220mm (8.7")

ITEM NO.	Length mm (Inch)
AT-HC12	220mm (8.7")



ITEM NO.	Length mm (Inch)
AT-HC14	220mm (8.7")

ITEM NO.	Length mm (Inch)
AT-HC16	230mm (9.1")

Extractors

Taper Bit Extractors

ITEM NO.	Capacity mm (Inch)	Length mm
010603	3mm (1/8")	60
010705	5mm (3/16")	70
010756	6mm (15/64")	75
010808	8mm (5/16")	80
010859	9mm (3/8")	85
011012	12mm (15/32")	105
011214	14mm (9/16")	125
011316	16mm (21/32")	130



AT-EX5 5pcs Taper Bit Extractor Set

- 5 Taper Bit Extractors:
(010603 ~ 010859)
3mm (1/8") - 5mm (3/16") -
6mm (15/64") - 8mm (5/16") -
9mm (3/8")



140g 120 Sets / 17.5 Kgs / 0.92 CUFT

Wheel Balancing Weight Tools

ITEM NO.	Size Inch	Length mm
560425	10"	250

- Designed for fitting and removing wheel balancing weights
- Chrome Vanadium Steel
- Phosphatised finish



Automotive Tools

Rigid Carbon Scrapers



ITEM NO.	Blade Style	Blade Width	Overall Length
595212	Straight	12mm	250mm



ITEM NO.	Blade Style	Blade Width	Overall Length
595226	Straight	26mm	200mm



ITEM NO.	Blade Style	Blade Width	Overall Length
595232	Straight	26mm	300mm

Trim Pad Remover

ITEM NO.	Length mm / Inch
AT-TPR	230mm (9.1")



Brake Spring Pliers

ITEM NO.	Length mm (Inch)
AT-BSP	330mm (13")

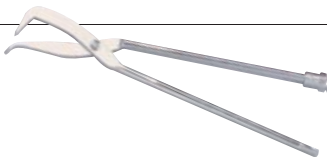

Miniature Awls, Hooks & Picks



ITEM NO.	Type	Blade Length	Overall Length
592801	Awl	75mm	150mm



ITEM NO.	Type	Blade Length	Overall Length
592802	Hook	75mm	150mm



ITEM NO.	Type	Blade Length	Overall Length
592803	45° Tip	75mm	150mm



ITEM NO.	Type	Blade Length	Overall Length
592804	90° Tip	75mm	150mm

PK-AHP4 4pcs Miniature Pick Set

- 1 Mini-Awl (592801)
- 1 Mini-Hook (592802)
- 1 Mini-Bent Tip 45° (592803)
- 1 Mini-Bent Tip 90° (592804)



130g 80 Sets / 11.5 Kgs / 1.80 CUFT

PK-OSP4 2pcs O-Ring Oil Seal Pick Set

- 1 Hook & O-Ring 90° Tip (Double End)
- 1 Bent Tip 90° & Bent Tip 45° (Double End)



40g 300 Sets / 12.5 Kgs / 2.70 CUFT

Grease Gun

AT-46012 Grease Gun

- 1 Grease Gun
- 1 Flexible Pipe
- 1 Rigid Pipe



1200g 20 Sets / 27 Kgs / 2.30 CUFT

- Standard 14 oz. cartridge
- Pressure filler
- Bulk 400 c.c.

Hinged Mirrors



ITEM NO.	Description
AT-RM15	50mm x 90mm



ITEM NO.	Description
AT-RM14	57mm Diameter

Magnetic Tools

Magnetic Pick-Up Tools

ITEM NO.	Length mm (Inch)
AT-PU22	215mm (8.5")

Magnetic Pick-Up Tools

ITEM NO.	Length mm (Inch)
AT-PU33	330~685mm (13~27")

Magnetic Pick-Up Tools

ITEM NO.	Length mm (Inch)
AT-B16	135~645mm (5.3 ~25.4")

Magnetic Bar Tool Holders

ITEM NO.	Length mm (Inch)
005012	305mm (12")
005015	405mm (16")
005024	610mm (24")

Magnetic Parts Trays

ITEM NO.	Description
a. 001036	Single - 150D x 40H
b. 002034	Double - 237L x 137W x 40H
c. 003047	Triple - 360L x 160W x 40H
d. 004048	Quad - 295L x 275W x 40H

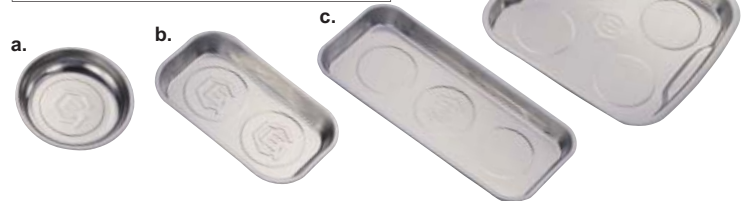

Socket Holders

Plastic Socket Holders

ITEM NO.	Drive Size
001002	1/4"
001003	3/8"
001004	1/2"
001006	3/4"

Socket Rails with Clips

ITEM NO.	Drive Size	Length mm	Clips pcs	Pack of
010152	1/4"	410	15	2
010153	3/8"	480	15	2
010154	1/2"	560	15	2
010156	3/4"	560	10	2

Tool Storage

TS-244 4 Drawer Top Chest

	Width	Depth	Height
Overall	655mm (25.8")	450mm (17.7")	390mm (15.4")
3 Drawer	572mm (22.5")	410mm (16.1")	41mm (1.6")
1 Drawer	572mm (22.5")	410mm (16.1")	60mm (2.4")

31.5 kgs



Add-on for
•TS-465
•TS-465P
•TS-467
•TS-467P

Tool Storage



TS-125 5 Tier Portable Tool Chest

	Width	Depth	Height
Overall	536mm (21.1")	258mm (10.2")	220mm (8.6")
4 Drawer	530mm (20.8")	125mm (5")	50mm (2")
1 Drawer	530mm (20.8")	253mm (10")	88mm (3.5")

6.5 kgs



TS-123 3 Drawer Tool Chest

	Width	Depth	Height
Overall	575mm (22.5")	230mm (9")	311mm (12.2")
3 Drawer	503mm (19.8")	193mm (7.6")	45mm (1.7")

10.5 kgs



Double Brakes

TS-465 5 Drawer Roller Cabinet

	Width	Depth	Height
Overall	686mm (27")	466mm (18.3")	666mm (26.2")
3 Drawer	581mm (22.8")	410mm (16.1")	60mm (2.4")
2 Drawer	581mm (22.8")	410mm (16.1")	140mm (5.5")

53.5 kgs

TS-465P (w/ Top Tray) 5 Drawer Roller Cabinet

	Width	Depth	Height
Overall	686mm (27")	466mm (18.3")	666mm (26.2")
3 Drawer	581mm (22.8")	410mm (16.1")	60mm (2.4")
2 Drawer	581mm (22.8")	410mm (16.1")	140mm (5.5")
Top Tray	890mm (35")	510mm (20.1")	45mm (1.8")

58 kgs



Double Brakes

TS-467 7 Drawer Roller Cabinet

	Width	Depth	Height
Overall	686mm (27")	466mm (18.3")	820mm (32.3")
5 Drawer	581mm (22.8")	410mm (16.1")	60mm (2.4")
2 Drawer	581mm (22.8")	410mm (16.1")	140mm (5.5")

65 kgs

TS-467P (w/ Top Tray) 7 Drawer Roller Cabinet

	Width	Depth	Height
Overall	686mm (27")	466mm (18.3")	820mm (32.3")
5 Drawer	581mm (22.8")	410mm (16.1")	60mm (2.4")
2 Drawer	581mm (22.8")	410mm (16.1")	140mm (5.5")
Top Tray	890mm (35")	510mm (20.1")	45mm (1.8")

70 kgs



TS-790 10 Drawer Top Chest

	Width	Depth	Height
Overall	660mm (26")	455mm (17.9")	483mm (19")
6 Drawer	169mm (6.7")	410mm (16.1")	45mm (1.8")
2 Drawer	576mm (22.7")	410mm (16.1")	45mm (1.8")
1 Drawer	169mm (6.7")	410mm (16.1")	122mm (4.8")
1 Drawer	576mm (22.7")	410mm (16.1")	56mm (2.2")

52 kgs



TS-797 7 Drawer Side Cabinet

	Width	Depth	Height
Overall	380mm (15")	460mm (18.1")	798mm (31.4")
5 Drawer	291mm (11.5")	410mm (16.1")	56mm (2.2")
2 Drawer	291mm (11.5")	410mm (16.1")	122mm (4.8")

37 kgs

TS-798 7 Drawer Roller Cabinet

	Width	Depth	Height
Overall	670mm (26.4")	460mm (18.1")	813mm (32")
5 Drawer	576mm (22.7")	410mm (16.1")	56mm (2.2")
2 Drawer	576mm (22.7")	410mm (16.1")	122mm (4.8")

64 kgs



Tool Storage

Jumbo Tool Storage



Add-on for
• TS-468

TS-246
6 Drawer Top Chest

	Width	Depth	Height
Overall	968mm (38")	450mm (18")	600mm (24")
4 Drawer	877mm (35")	410mm (16.1")	54mm (2.1")
2 Drawer	877mm (35")	410mm (16.1")	100mm (3.9")

59.5 kgs



Double Brakes

TS-468
7 Drawer Roller Cabinet

	Width	Depth	Height
Overall	980mm (39")	463mm (18")	820mm (32.3")
5 Drawer	877mm (35")	410mm (16.1")	60mm (2.4")
2 Drawer	877mm (35")	410mm (16.1")	124mm (4.9")

86 kgs



Add-on for
• TS-796

TS-710
6 Drawer Top Chest

	Width	Depth	Height
Overall	806mm (32")	484mm (19")	540mm (21")
5 Drawer	734mm (29")	422mm (17")	40mm (1.6")
1 Drawer	734mm (29")	422mm (17")	90mm (3.5")

72.5 kgs



Add-on for
• TS-796

TS-748
8 Drawer Side Cabinet

	Width	Depth	Height
Overall	506mm (20")	495mm (19.5")	920mm (36")
3 Drawer	390mm (15")	422mm (17")	45mm (1.8")
3 Drawer	390mm (15")	422mm (17")	85mm (3.4")
2 Drawer	390mm (15")	422mm (17")	140mm (5.5")

63 kgs

TS-796
8 Drawer Roller Cabinet

	Width	Depth	Height
Overall	850mm (33")	495mm (19.5")	946mm (37")
3 Drawer	734mm (29")	422mm (17")	45mm (1.8")
3 Drawer	734mm (29")	422mm (17")	85mm (3.4")
2 Drawer	734mm (29")	422mm (17")	140mm (5.5")

138 kgs



Tool Storage

TS-764
Roll Cart with 4 Drawers

	Width	Depth	Height
Overall	778mm (31")	512mm (20")	888mm (35")
2 Drawer	298mm (12")	434mm (17")	89mm (3.5")
1 Drawer	625mm (25")	434mm (17")	89mm (3.5")
1 Drawer	625mm (25")	434mm (17")	137mm (5.4")

65.5 kgs



TS-768
Roll Cart with 5 Drawers

	Width	Depth	Height
Overall	1240mm (49")	517mm (20")	888mm (35")
4 Drawer	528mm (21")	445mm (18")	89mm (3.5")
1 Drawer	1088mm (43")	445mm (18")	120mm (4.7")

95 kgs

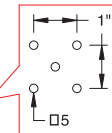

DS-111
Display Stand

	Width	Depth	Height
Overall	945mm (37")	400mm (16")	2245mm (88")

41 kgs

WS-759
Multi-Function Workstation Set

	Width	Depth	Height
Overall	1530mm (60.2")	706mm (27.8")	1590mm (62.6")
2 Drawer	569mm (22.4")	275mm (10.8")	41mm (1.6")
1 Drawer	569mm (22.4")	275mm (10.8")	64mm (2.5")
2 Cabinet	400mm (15.7")	200mm (7.9")	500mm (19.7")

86 kgs

Accessory:

- Cutting Board W 1500mm(59") x D 700mm(27.5") x H 6mm(0.24")
- 4 Sets Adjustable Device
- 10pcs Single Hooks
- 10pcs Double Hooks
- 10pcs U Shape Hooks



1/6 Tray Sets

GS-222M 22pcs 1/4" Dr. Metric Deep Hand Socket Set

- 10 6pt. Socket 5 - 5.5 - 6 - 7 - 8 - 9 - 10 - 11 - 12 - 13mm
- 8 6pt. Deep Socket 6 - 7 - 8 - 9 - 10 - 11 - 12 - 13mm
- 1 Universal Joint 1 Ext. 50mmL
- 1 Socket Driver 1 Quick Release Ratchet



1/6 Tray
 930g 10 Sets / 10 Kgs / 0.93 CUFT

TW-230M 30pcs 1/4" Dr. Metric Deep Hand Socket Set

- 11 12pt. Socket 5 - 5.5 - 6 - 7 - 8 - 9 - 10 - 11 - 12 - 13 - 14mm
- 12 6pt. Deep Socket 4 - 5 - 5.5 - 6 - 7 - 8 - 9 - 10 - 11 - 12 - 13 - 14mm
- 1 Universal Joint 3 Ext. 50 - 100 - 150mmL
- 1 Sliding T-Handle 1 Quick Release Ratchet
- 1 Socket Driver



1/6 Tray
 1220g 10 Sets / 13.5 Kgs / 0.93 CUFT

TW-227MS 27pcs 1/4" Dr. Metric & SAE Hand Socket Set

- 11 12pt. Socket 5 - 5.5 - 6 - 7 - 8 - 9 - 10 - 11 - 12 - 13 - 14mm
- 10 12pt. Socket 3/16 - 7/32 - 1/4 - 9/32 - 5/16 - 11/32 - 3/8 - 7/16 - 1/2 - 9/16"
- 1 Universal Joint 2 Ext. 50 - 150mmL
- 1 Sliding T-Handle 1 Quick Release Ratchet
- 1 Socket Driver



1/6 Tray
 1000g 10 Sets / 11 Kgs / 0.93 CUFT

EX-2349 9pcs 1/4, 3/8 & 1/2" Dr. Extension Bar Set

- 3 1/4" Dr. Ext. 50 - 100 - 150mmL
- 3 3/8" Dr. Ext. 45 - 75 - 150mmL
- 3 1/2" Dr. Ext. 50 - 125 - 250mmL



1/6 Tray
 1170g 10 Sets / 13 Kgs / 0.93 CUFT

BE-2349 9pcs 1/4, 3/8 & 1/2" Dr. Wobble Extension Bar Set

- 3 1/4" Dr. Wobble Ext. 50 - 100 - 150mmL
- 3 3/8" Dr. Wobble Ext. 45 - 75 - 150mmL
- 3 1/2" Dr. Wobble Ext. 50 - 125 - 250mmL



1/6 Tray
 1170g 10 Sets / 13 Kgs / 0.93 CUFT

IS-314M 14pcs 3/8" Dr. Metric Impact Socket Set

- 13 6pt. Socket 8 - 9 - 10 - 11 - 12 - 13 - 14 - 15 - 16 - 17 - 18 - 19 - 21mm
- 1 Extension 75mmL



1/6 Tray
 960g 10 Sets / 10.5 Kgs / 0.93 CUFT

IS-415M 15pcs 1/2" Dr. Metric Impact Socket Set

- 14 6pt. Socket 10 - 11 - 12 - 13 - 14 - 15 - 16 - 17 - 18 - 19 - 21 - 22 - 23 - 24mm
- 1 Extension 125mmL



1/6 Tray
 1830g 10 Sets / 19.5 Kgs / 0.93 CUFT

1/6 Tray Sets

DI-415M 15pcs 1/2" Dr. Metric Deep Thin Wall Impact Socket Set

- 15 6pt. Thin Wall Socket 10 - 11 - 12 - 13 - 14 - 15 - 16 - 17 - 18 - 19 - 20 - 21 - 22 - 23 - 24mm



1/6 Tray
 2100g 10 Sets / 23 Kgs / 0.93 CUFT

DI-407M 7pcs 1/2" Dr. Metric Spindle Nut Impact Socket Set

- 7 6pt. Deep Socket 30 - 32 - 33 - 34 - 35 - 36 - 38mm



1/6 Tray
 3750g 6 Sets / 24 Kgs / 0.94 CUFT

DI-407S 7pcs 1/2" Dr. SAE Spindle Nut Impact Socket Set

- 7 6pt. Deep Socket 1 1/8 - 1 3/16 - 1 1/4 - 1 5/16 - 1 3/8 - 1 7/16 - 1 1/2"



1/6 Tray
 3750g 6 Sets / 24 Kgs / 0.94 CUFT

IE-2349 9pcs 1/4, 3/8 & 1/2" Dr. Impact Extension Bar Set

- 3 1/4" Dr. Impact Ext. 50 - 100 - 150mmL
- 3 3/8" Dr. Impact Ext. 45 - 75 - 150mmL
- 3 1/2" Dr. Impact Ext. 50 - 125 - 250mmL



1/6 Tray
 1170g 10 Sets / 13 Kgs / 0.93 CUFT

TX-412 12pcs 1/2" Dr. Bit Socket Set

- 4 1/2" Dr. Hex: 5mm(190mmL) & 6 - 7 - 8mm(110mmL)
- 4 1/2" Dr. Star: T40 - 45 - 55(110mmL) & T70(150mmL)
- 4 1/2" Dr. Triple Square: M6 - 8 - 10 - 12(110mmL)



1/6 Tray
 1570g 10 Sets / 17 Kgs / 0.93 CUFT

OW-707M 7pcs Metric Open End Wrench Set

- 7 Open End Wrenches: 6x7 - 8x9 - 10x11 - 12x13 - 14x15 - 16x17 - 18x19mm



1/6 Tray
 810g 10 Sets / 9.5 Kgs / 0.93 CUFT

OW-705S 5pcs SAE Open End Wrench Set

- 5 Open End Wrenches: 1/4x5/16 - 3/8x7/16 - 1/2x9/16 - 5/8x11/16 - 3/4x7/8"



1/6 Tray
 720g 10 Sets / 8.5 Kgs / 0.93 CUFT

Tool Trays

1/6 Tray Sets

TX-2324 24pcs Star Wrench Set

- 4 E-Star Wrench: E6xE8 - E10xE12 - E14xE18 - E20xE24
- 7 3/8" Dr. E-Star Hand Socket: E10 - 11 - 12 - 14 - 16 - 18 - 20
- 10 Tamperproof Star Bit: T8 ~ T50 (30mmL)
- 3 Bit Holder: 1/4"Dr.x1/4" - 3/8"Dr.x1/4" - 3/8"Dr.x5/16"



1/6 Tray 980g 10 Sets / 11 Kgs / 0.93 CUFT

CW-404MS 4pcs 1/2" Dr. Metric & SAE Thin Wall Impact Socket Set

- 3 6pt. Thin Wall Socket w/ Plastic Sleeve 17 - 19 - 21mm
- 1 6pt. Thin Wall Socket w/ Plastic Sleeve 13/16"



1/6 Tray 1170g 10 Sets / 13 Kgs / 0.93 CUFT

CW-406M 6pcs 1/2" Dr. Metric Car Wheel COLOUR MATCH® Set

- 3 6pt. Thin Wall Socket w/ Plastic Sleeve 17 - 19 - 21mm
- 3 Torque Extension Bar 80 ft.lb.(110Nm) - 90 ft.lb.(120Nm) - 110 ft.lb.(150Nm) -



1/6 Tray 1760g 5 Sets / 10 Kgs / 0.93 CUFT

RP-5504 4pcs Retaining Ring Pliers Set

- 1 Straight Nose, External (550750)
- 1 Straight Nose, Internal (550751)
- 1 90° Bent Nose, External (550752)
- 1 90° Bent Nose, Internal (550753)



1/6 Tray 830g 10 Sets / 10 Kgs / 0.93 CUFT

FEATURES:

Customize your drawer layout to your own personal style and need with durable plastic trays, they make storing and retrieving tools fast and easy. Always find the tools you need in an instant, like a professional is expected to be.

There are five interchangeable sizes (1/6, 1/3, 1/2, 2/3, full size) to choose from. For the best fit, use with Genius Tools' brand tool chests.

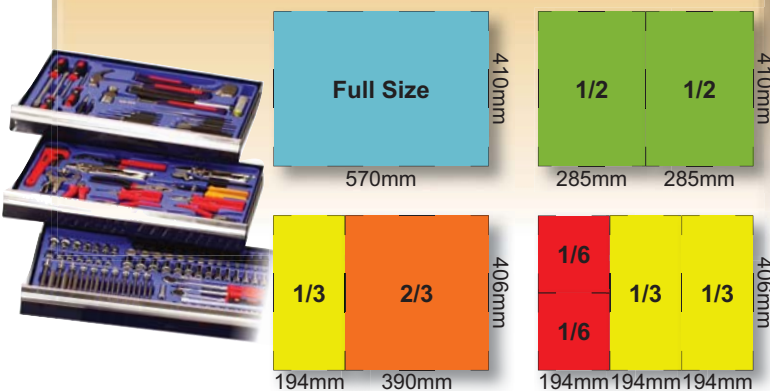

1/3 Tray Sets

TF-332M 32pcs 3/8" Dr. Metric Deep Impact Socket Set (CR-V)

- 16 6pt. Socket 7 - 8 - 9 - 10 - 11 - 12 - 13 - 14 - 15 - 16 - 17 - 18 - 19 - 20 - 21 - 22mm
- 16 6pt. Deep Socket 7 - 8 - 9 - 10 - 11 - 12 - 13 - 14 - 15 - 16 - 17 - 18 - 19 - 20 - 21 - 22mm



1/3 Tray 3650g 5 Sets / 19.5 Kgs / 0.93 CUFT

CM-332M 32pcs 3/8" Dr. Metric Deep Impact Socket Set (CR-Mo)

- 16 6pt. Socket 7 - 8 - 9 - 10 - 11 - 12 - 13 - 14 - 15 - 16 - 17 - 18 - 19 - 20 - 21 - 22mm
- 16 6pt. Deep Socket 7 - 8 - 9 - 10 - 11 - 12 - 13 - 14 - 15 - 16 - 17 - 18 - 19 - 20 - 21 - 22mm



1/3 Tray 3450g 5 Sets / 18 Kgs / 0.93 CUFT

TF-425M 25pcs 1/2" Dr. Metric Impact Socket Set (CR-V)

- 25 6pt. Socket 8 - 9 - 10 - 11 - 12 - 13 - 14 - 15 - 16 - 17 - 18 - 19 - 20 - 21 - 22 - 23 - 24 - 25 - 26 - 27 - 28 - 29 - 30 - 31 - 32mm

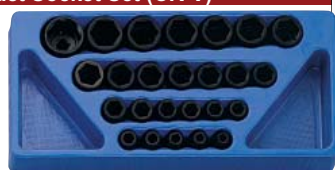

1/3 Tray 3700g 3 Sets / 13 Kgs / 0.82 CUFT

TF-425MD 25pcs 1/2" Dr. Metric Deep Impact Socket Set (CR-V)

- 25 6pt. Deep Socket 8 - 9 - 10 - 11 - 12 - 13 - 14 - 15 - 16 - 17 - 18 - 19 - 20 - 21 - 22 - 23 - 24 - 25 - 26 - 27 - 28 - 29 - 30 - 31 - 32mm



1/3 Tray 6200g 3 Sets / 20 Kgs / 0.82 CUFT

IS-425M 25pcs 1/2" Dr. Metric Impact Socket Set (CR-Mo)

- 25 6pt. Socket 8 - 9 - 10 - 11 - 12 - 13 - 14 - 15 - 16 - 17 - 18 - 19 - 20 - 21 - 22 - 23 - 24 - 25 - 26 - 27 - 28 - 29 - 30 - 32 - 36mm



1/3 Tray 4000g 3 Sets / 13 Kgs / 0.82 CUFT

DI-425M 25pcs 1/2" Dr. Metric Deep Impact Socket Set (CR-Mo)

- 25 6pt. Deep Socket 8 - 9 - 10 - 11 - 12 - 13 - 14 - 15 - 16 - 17 - 18 - 19 - 20 - 21 - 22 - 23 - 24 - 25 - 26 - 27 - 28 - 29 - 30 - 32 - 36mm



1/3 Tray 7000g 3 Sets / 22 Kgs / 0.82 CUFT

IS-422S 22pcs 1/2" Dr. SAE Impact Socket Set (CR-Mo)

- 22 6pt. Socket 5/16 - 3/8 - 7/16 - 1/2 - 9/16 - 19/32 - 5/8 - 11/16 - 3/4 - 25/32 - 13/16 - 7/8 - 15/16 - 1" - 1 1/16 - 1 1/8 - 1 3/16 - 1 1/4 - 1 5/16 - 1 3/8 - 1 7/16 - 1 1/2"



1/3 Tray 4330g 3 Sets / 14 Kgs / 0.82 CUFT

DI-422S 22pcs 1/2" Dr. SAE Deep Impact Socket Set (CR-Mo)

- 22 6pt. Deep Socket 5/16 - 3/8 - 7/16 - 1/2 - 9/16 - 19/32 - 5/8 - 11/16 - 3/4 - 25/32 - 13/16 - 7/8 - 15/16 - 1" - 1 1/16 - 1 1/8 - 1 3/16 - 1 1/4 - 1 5/16 - 1 3/8 - 1 7/16 - 1 1/2"



1/3 Tray 6700g 3 Sets / 21 Kgs / 0.82 CUFT

1/3 Tray Sets

DI-417MD 17pcs 1/2" Dr. Metric Deep Thin Wall Impact Socket Set

- 17 12pt. Deep Thin Wall Socket
8 - 9 - 10 - 11 - 12 - 13 - 14 - 15 -
16 - 17 - 18 - 19 - 20 - 21 - 22 -
23 - 24mm



1/3 Tray
3340g 5 Sets / 18 Kgs / 0.93 CUFT

EU-335M 35pcs 3/8" Dr. Metric Deep Hand Socket Set

- 15 12pt. Skt. 7 - 8 - 9 - 10 - 11 - 12 - 13 - 14 - 15 - 16 - 17 - 18 - 19 - 21 - 22mm
- 15 6pt. Deep Socket 7 - 8 - 9 - 10 - 11 -
12 - 13 - 14 - 15 - 16 - 17 - 18 -
19 - 21 - 22mm
- 1 Universal Joint 1 Sliding T-Handle
- 2 Ext. 150 - 250mmL
- 1 Quick Release Ratchet



1/3 Tray
3470g 5 Sets / 18.5 Kgs / 0.93 CUFT

GS-330S 30pcs 3/8" Dr. SAE Deep Hand Socket Set

- 13 12pt. Socket 1/4 - 5/16 - 11/32 - 3/8 - 7/16 - 1/2 - 9/16 - 19/32 - 5/8 - 11/16 -
3/4 - 13/16 - 7/8"
- 12 6pt. Deep Socket 1/4 - 5/16 - 11/32 -
3/8 - 7/16 - 1/2 - 9/16 - 5/8 - 11/16 -
3/4 - 13/16 - 7/8"
- 1 Universal Joint 1 Sliding T-Handle
- 2 Ext. 150 - 250mmL
- 1 Quick Release Ratchet



1/3 Tray
3110g 5 Sets / 17 Kgs / 0.93 CUFT

SS-425M 25pcs 1/2" Dr. Metric Hand Socket Set

- 25 6pt. Socket
8 - 9 - 10 - 11 - 12 - 13 - 14 - 15 -
16 - 17 - 18 - 19 - 20 - 21 - 22 -
23 - 24 - 25 - 26 - 27 - 28 - 29 -
30 - 32 - 36mm



1/3 Tray
3500g 3 Sets / 12 Kgs / 0.82 CUFT

DS-425M 25pcs 1/2" Dr. Metric Deep Hand Socket Set

- 25 6pt. Deep Socket
8 - 9 - 10 - 11 - 12 - 13 - 14 - 15 -
16 - 17 - 18 - 19 - 20 - 21 - 22 -
23 - 24 - 25 - 26 - 27 - 28 - 29 -
30 - 32 - 36mm



1/3 Tray
7000g 3 Sets / 22 Kgs / 0.82 CUFT

SS-422S 22pcs 1/2" Dr. SAE Hand Socket Set

- 22 6pt. Socket
5/16 - 3/8 - 7/16 - 1/2 - 9/16 - 19/32 -
5/8 - 11/16 - 3/4 - 25/32 - 13/16 - 7/8 -
15/16 - 1" - 1 1/16 - 1 1/8 - 1 3/16 -
1 1/4 - 1 5/16 - 1 3/8 - 1 7/16 - 1 1/2"



1/3 Tray
4000g 3 Sets / 13 Kgs / 0.82 CUFT

DS-422S 22pcs 1/2" Dr. SAE Deep Hand Socket Set

- 22 6pt. Deep Socket
5/16 - 3/8 - 7/16 - 1/2 - 9/16 - 19/32 -
5/8 - 11/16 - 3/4 - 25/32 - 13/16 - 7/8 -
15/16 - 1" - 1 1/16 - 1 1/8 - 1 3/16 -
1 1/4 - 1 5/16 - 1 3/8 - 1 7/16 - 1 1/2"



1/3 Tray
6700g 3 Sets / 21 Kgs / 0.82 CUFT

1/3 Tray Sets

TW-423M 23pcs 1/2" Dr. Metric Hand Socket Set

- 18 12pt. Socket 8 - 10 - 11 - 12 - 13 -
14 - 15 - 16 - 17 - 18 - 19 - 21 -
22 - 23 - 24 - 27 - 30 - 32mm
- 1 Universal Joint 1 Sliding T-Handle
- 2 Ext. 125 - 250mmL
- 1 Quick Release Ratchet



1/3 Tray
4180g 5 Sets / 22 Kgs / 0.93 CUFT

TW-423S 23pcs 1/2" Dr. SAE Hand Socket Set

- 18 12pt. Socket 5/16 - 3/8 - 7/16 - 1/2 -
9/16 - 19/32 - 5/8 - 11/16 - 3/4 -
25/32 - 13/16 - 7/8 - 15/16 - 1" -
1 1/16 - 1 1/8 - 1 3/16 - 1 1/4"
- 1 Universal Joint 1 Sliding T-Handle
- 2 Ext. 5 - 10"L
- 1 Quick Release Ratchet



1/3 Tray
4400g 5 Sets / 23 Kgs / 0.93 CUFT

TX-2353 53pcs 1/4" & 3/8" Dr. Complete Bit Socket Set

- 5 1/4" & 3/8" Dr. Slotted 3 - 4 - 5 - 6 - 8mm (45 & 50mmL)
- 4 1/4" & 3/8" Dr. Philips #1 - 2 - 3 - 4 (45 & 50mmL)
- 10 1/4" & 3/8" Dr. Metric Hex 2 - 2.5 - 3 - 4 - 5 - 6 - 7 - 8 - 10 - 12 (45 & 50mmL)
- 14 1/4" & 3/8" Dr. SAE Hex
1/16 - 5/64 - 3/32 - 7/64 - 1/8 -
5/32 - 3/16 - 7/32 - 1/4 - 9/32 -
5/16 - 3/8 - 7/16 - 1/2" (45 & 50mmL)
- 14 1/4" & 3/8" Dr. Star
T6 - 7 - 8 - 9 - 10 - 15 - 20 - 25 - 27 -
30 - 40 - 45 - 50 - 55 (45 & 50mmL)
- 6 3/8" Dr. Triple Square M4 - 5 - 6 - 8 - 10 - 12 (50mmL)



1/3 Tray
2500g 5 Sets / 13.5 Kgs / 0.93 CUFT

BS-3424P 24pcs 3/8" & 1/2" Dr. Slotted & Philips Bit Socket Set

- 10 3/8" Dr. Slotted
4 - 5 - 6 - 8 - 9mm (50 & 140mmL)
- 6 1/2" Dr. Slotted
12 - 14 - 16mm (80 & 150mmL)
- 4 3/8" Dr. Philips #1 - 2 (50 & 140mmL)
- 4 1/2" Dr. Philips #3 - 4 (80 & 150mmL)



1/3 Tray
2770g 5 Sets / 15 Kgs / 0.93 CUFT

BS-3424H 24pcs 3/8" & 1/2" Dr. SAE Hex Bit Socket Set

- 14 3/8" Dr. SAE Hex 1/8 - 5/32 - 3/16 -
7/32 - 1/4 - 9/32 - 5/16" (50 & 140mmL)
- 10 1/2" Dr. SAE Hex 3/8 - 7/16 - 1/2 -
9/16 - 5/8" (80 & 150mmL)



1/3 Tray
3245g 5 Sets / 17.5 Kgs / 0.93 CUFT

BS-3424T 24pcs 3/8" & 1/2" Dr. Star Bit Socket Set

- 14 3/8" Dr. Star T10 - 15 - 20 - 25 - 27 -
30 - 40 (50 & 140mmL)
- 10 1/2" Dr. Star T45 - 50 - 55 - 60 - 70
(80 & 150mmL)



1/3 Tray
2665g 5 Sets / 14.5 Kgs / 0.93 CUFT

BS-3424TA 24pcs 3/8" & 1/2" Dr. Tamperproof Star Bit Socket Set

- 14 3/8" Dr. Tamperproof Star
T10 - 15 - 20 - 25 - 27 - 30 - 40
(50 & 140mmL)
- 10 1/2" Dr. Star Tamperproof
T45 - 50 - 55 - 60 - 70
(80 & 150mmL)



1/3 Tray
2665g 5 Sets / 14.5 Kgs / 0.93 CUFT

1/3 Tray Sets

TR-507S 7pcs Slotted & Philips Screwdriver Set

4 Slotted:
3.0x155 - 4.0x180 -
6.0x250 - 6.5x250mmL

3 Philips: #0x75 -
#1x200 - #2x225mmL



920g 5 Sets / 6 Kgs / 0.93 CUFT

TR-508Z 8pcs Combination Screwdriver Set

4 Slotted: 5.5x200 -
6.5x250 - 8.0x280 -
10.0x320mmL

2 Philips:
#1x200 - #2x225mmL

2 Posidriv:
#1x180 - #2x250mmL



1340g 10 Sets / 14.5 Kgs / 1.58 CUFT

TR-510TA 10pcs Tamperproof Star Screwdriver Set

10 Tamperproof Star:
T8x150 - T10x180 -
T15x180 - T20x200 -
T25x200 - T27x225 -
T30x225 - T40x255 -
T45x255 - T50x235mmL



1480g 10 Sets / 16 Kgs / 1.58 CUFT

HR-5608M 8pcs Metric Hex Screwdriver Set

8 Metric Hex:
2x150 - 2.5x150 -
3x150 - 4x170 -
5x185 - 6x185 -
7x235 - 8x235mmL



1140g 10 Sets / 14 Kgs / 1.58 CUFT

HR-5611S 11pcs SAE Hex Screwdriver Set

11 SAE Hex: 1/16"x150 -
5/64"x150 - 3/32"x150 -
7/64"x150 - 1/8"x150 -
5/32"x170 - 3/16"x185 -
7/32"x185 - 1/4"x225 -
9/32"x235 - 5/16"x235mmL



1390g 10 Sets / 16 Kgs / 1.58 CUFT

HR-578MW 8pcs Metric Wobble Hex Screwdriver Set

8 Metric Wobble Hex:
3x150 - 4x170 - 5x185 -
6x185 - 7x235 - 8x235 -
9x235 - 10x235mmL



1390g 10 Sets / 16.5 Kgs / 1.58 CUFT

HR-578SW 8pcs SAE Wobble Hex Screwdriver Set

11 SAE Wobble Hex:
1/8"x150 - 5/32"x170 -
3/16"x185 - 7/32"x185 -
1/4"x225 - 9/32"x235 -
5/16"x235 - 3/8"x235mmL

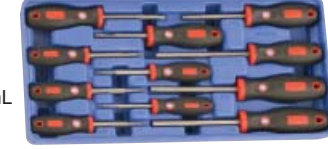

1340g 10 Sets / 15.5 Kgs / 1.58 CUFT

1/3 Tray Sets

TL-508 8pcs Slotted & Philips Screwdriver Set

4 Slotted: 6.5x86 -
6.5x210 - 8.0x295 -
10.0x320mmL

4 Philips: #1x86 -
#1x185 - #2x235 -
#2x310mmL



1350g 20 Sets / 28 Kgs / 3.60 CUFT

TX-512A 12pcs Tamperproof Star Screwdriver Set

12 Tamperproof Star:
T6x145 - T7x145 -
T8x145 - T9x145 -
T10x175 - T15x175 -
T20x195 - T25x195 -
T27x215 - T30x215 -
T40x250 - T45x250mmL



1400g 10 Sets / 15 Kgs / 1.58 CUFT

HS-5610M 10pcs Metric Hex Screwdriver Set

10 Metric Hex:
2x145 - 2.5x145 -
3x145 - 4x145 -
5x180 - 6x180 -
7x225 - 8x225 -
9x225 - 10x225mmL



1470g 5 Sets / 8.4 Kgs / 0.93 CUFT

HS-5612S 12pcs SAE Hex Screwdriver Set

12 SAE Hex: 1/16"x145 -
5/64"x145 - 3/32"x145 -
7/64"x145 - 1/8"x145 -
5/32"x145 - 3/16"x180 -
7/32"x180 - 1/4"x225 -
9/32"x225 - 5/16"x225
3/8"x225mmL



1500g 5 Sets / 8.5 Kgs / 0.93 CUFT

HS-5708MW 8pcs Metric Wobble Hex Screwdriver Set

8 Metric Wobble Hex:
3x145 - 4x145 - 5x180 -
6x180 - 7x225 - 8x225 -
9x225 - 10x225mmL



1370g 5 Sets / 7.9 Kgs / 0.93 CUFT

HS-5708SW 8pcs SAE Wobble Hex Screwdriver Set

8 SAE Wobble Hex:
1/8"x145 - 5/32"x145 -
3/16"x180 - 7/32"x180 -
1/4"x225 - 9/32"x225 -
5/16"x225 -
3/8"x225mmL



1290g 5 Sets / 7.5 Kgs / 0.93 CUFT

SB-247M 47pcs Screwdriver Bit Set

4 Posidriv (30 & 88mmL)
#1 - 2

12 Hex (30 & 88mmL)
4 - 5 - 6 - 7 - 8 - 10mm

20 Tamperproof Star
(30 & 88mmL)
T10 - 15 - 20 - 25 - 27 - 30 - 40 - 45 - 50 - 55

8 Triple Square: M5 - 6 - 8 - 10 (30 & 88mmL)

3 Bit Holder 3/8"Dr. x 1/4" - 5/16" - 10mm Hex Shank



1470g 10 Sets / 16 Kgs / 1.58 CUFT

1/3 Tray Sets

CW-007M 7pcs Metric Combination Wrench Set

7 Metric Combination:
(748210 ~ -24)
10 - 12 - 14 - 17 - 19 -
22 - 24mm



1/3 Tray 1850g 10 Sets / 19.5 Kgs / 1.58 CUFT

PR-015M 15pcs Metric Combination Wrench Set

15 Metric Combination:
(748207 ~ -24)
7 - 8 - 9 - 10 - 11 - 12 -
13 - 14 - 15 - 16 - 17 -
18 - 19 - 22 - 24mm



1/3 Tray 2500g 10 Sets / 26.5 Kgs / 1.58 CUFT

GW-7607M 7pcs Metric Combination Ratcheting Wrench Set

7 Metric Combination:
(768508 ~ -19)
8 - 10 - 12 - 13 -
14 - 17 - 19mm



1/3 Tray 1260g 10 Sets / 13.5 Kgs / 1.58 CUFT

DE-707M 7pcs Metric Offset Box End Wrench Set

7 Metric Box End:
(740607 ~ -1819)
6x7 - 8x9 - 10x11 -
12x13 - 14x15 -
16x17 - 18x19mm



1/3 Tray 1340g 10 Sets / 14.5 Kgs / 1.58 CUFT

CP-5704 4pcs Pliers Set

1 8" Side Cutter Pliers (550812)
1 7" Diagonal Cutting Pliers (550707)
1 8" Chain Nose Pliers w/ Cutter (550804)
1 8" Combination Slip Joint Pliers (550809)



1/3 Tray 1630g 5 Sets / 9.5 Kgs / 0.93 CUFT

CP-5804 4pcs General Purpose Pliers Set

1 6" Chain Nose Pliers w/ Cutter (550604D)
1 6" Diagonal Cutting Pliers (550607D)
1 7" Side Cutter Pliers (550712D)
1 10" Water Pump Pliers (551011D)



1/3 Tray 1590g 5 Sets / 9 Kgs / 0.93 CUFT

CW-408MS 8pcs 1/2" Dr. Metric & SAE Metric COLOUR MATCH®

4 1/2" Dr. 6pt. Thin Wall Socket w/ Plastic Sleeve
448517W 17mm
448519W 19mm
448521W 21mm
468526W 13/16"

4 1/2" Torque Extension Bar
487080 80 ft.lb. (110Nm)
487090 90 ft.lb. (120Nm)
487100 100 ft.lb. (135Nm)
487110 110 ft.lb. (150Nm)



1/3 Tray 2170g 5 Sets / 12 Kgs / 0.93 CUFT

1/2 Tray Sets

MS-042M 42pcs 3/8" Dr. Metric Impact Socket & Star Socket Set

7 3/8"Dr. E-Star Hand Socket
E10 - 11 - 12 - 14 - 16 - 18 - 20
16 3/8"Dr. Deep Impact Socket 7 - 8 - 9 - 10 - 11 - 12 -
13 - 14 - 15 - 16 - 17 - 18 - 19 - 20 - 21 - 22mm
12 3/8"Dr. Swivel Impact Socket 8 - 9 - 10 - 11 - 12 -
13 - 14 - 15 - 16 - 17 - 18 - 19mm
3 3/8"Dr. Impact Ext. 75 - 125 - 200mmL
1 3/8"Dr. Impact Uni. Joint 1 3/8"Dr. L-Handle
2 3/8"Dr. Flex Head Ratchet & Stubby Ratchet



1/2 Tray 5080g 3 Sets / 16.5 Kgs / 1.35 CUFT

MS-065S 65pcs 3/8" Dr. Head Driver & Impact Socket Set

13 3/8"Dr. Impact Socket 5/16 - 11/32 - 3/8 - 7/16 - 1/2 -
9/16 - 19/32 - 5/8 - 11/16 - 3/4 - 25/32 - 13/16 - 7/8"
8 3/8"Dr. Swivel Impact Socket
5/16 - 3/8 - 7/16 - 1/2 - 9/16 - 5/8 - 11/16 - 3/4"
10 3/8"Dr. Hex Head 5/32 - 3/16 - 7/32 - 1/4 - 5/16 -
3/8 - 7/16 - 1/2 - 9/16 - 5/8"
11 3/8"Dr. Hex Head
4 - 5 - 6 - 7 - 8 - 9 - 10 - 12 - 14 - 16 - 17mm
10 3/8"Dr. Star Head
T10 - 15 - 20 - 25 - 27 - 30 - 40 - 45 - 50 - 55
3 3/8"Dr. Slotted Head 5.5 - 8 - 10mm
4 3/8"Dr. Phillips Head #1 - 2 - 3 - 4
5 3/8"Dr. Triple Square Head M5 - 6 - 8 - 10 - 12
1 3/8"Dr. Impact Driver



1/2 Tray 4920g 3 Sets / 16 Kgs / 1.35 CUFT

MS-027S 27pcs 1/2" Dr. SAE Impact Socket & Accessory Set

10 1/2"Dr. Deep Impact Socket 15/16 - 1" - 1 1/16 -
1 1/8 - 1 3/16 - 1 1/4 - 1 5/16 - 1 3/8 - 1 7/16 - 1 1/2"
8 1/2"Dr. Swivel Impact Socket
7/16 - 1/2 - 9/16 - 5/8 - 11/16 - 3/4 - 13/16 - 7/8"
4 1/2"Dr. Hex Bit Socket
9/16 - 5/8 - 11/16 - 3/4" (80mmL)
3 1/2"Dr. Impact Ext. 75 - 125 - 250mmL
1 1/2"Dr. Impact Universal Joint
1 1/2"Dr. L-Handle



1/2 Tray 8660g 3 Sets / 27 Kgs / 1.35 CUFT

MS-435I 35pcs 1/2" Dr. Metric Deep Impact Socket Set (Cr-V)

15 1/2"Dr. Impact Socket
10 - 12 - 13 - 14 - 15 - 16 - 17 - 18 - 19 - 21 -
22 - 24 - 27 - 30 - 32mm
15 1/2"Dr. Deep Impact Socket
10 - 12 - 13 - 14 - 15 - 16 - 17 - 18 - 19 - 21 -
22 - 24 - 27 - 30 - 32mm
4 1/2"Dr. Impact Extension Bars
50 - 75 - 125 - 250mmL
1 1/2"Dr. Impact Universal Joint



1/2 Tray 7100g 3 Sets / 23 Kgs / 1.35 CUFT

NEW

1/2 Tray Sets

MS-121M 121pcs 1/4" Dr. Metric Hand Socket & Bit Set **NEW**

- 12 1/4"Dr. Socket 4 ~ 13mm
- 8 1/4"Dr. Deep Hand Socket 5 ~ 13mm
- 14 1/4"Dr. Head Socket
Hex 3 ~ 10mm - Slotted 4.0 ~ 6.5 - Philips #1 ~ 3
- 6 1/4"Dr. E-Star Socket E4 ~ 10
- 9 1/4"Dr. Star Bit Socket T8 - 40
- 44 Slotted Bit 3.0 ~ 7.0mm - Philip Bit #0 ~ 3 -
Hex Bit 2 ~ 8mm - Star Bit T6 ~ 40 -
Tamperproof Star T7 ~ 45 - Triple Square M4 ~ 6
- 9 Wobble Hex Key 1.5 ~ 10mm
- 10 Tamperproof Star Key T9 ~ 50
- 3 1/4"Dr. Bit Holder - Adapter - Universal Joint
- 4 1/4"Dr. Ext. 50 - 100mmL & Wobble Ext. 225mmL & Flex. Ext. 150mmL
- 2 1/4"Dr. Socket Driver & Quick Release Ratchet



1/2 Tray 2900g 3 Sets / 10.5 Kgs / 1.35 CUFT

MS-071M 71pcs 3/8" Dr. Metric Hand Socket & Bit Socket Set

- 24 3/8"Dr. Shallow & Deep Hand Socket 8 - 9 - 10 -
11 - 12 - 13 - 14 - 15 - 16 - 17 - 18 - 19mm
- 6 3/8"Dr. E-Star Socket E10 - 11 - 12 - 14 - 16 - 18
- 31 3/8"Dr. Bit Socket Slotted 4.0 ~ 6.0mm -
Philips #1 ~ 3 - Hex 3 ~ 12mm -
Star T10 ~ 55 - Triple Square M5 ~ 12
- 2 3/8"Dr. Adapter - Universal Joint
- 2 3/8"Dr. Spark Plug 16mm - 20.6mm
- 4 3/8"Dr. Extension Bar 75 - 150 - 200mmL -
3/8"Dr. Wobble Extension Bar 45mmL
- 1 1/4" & 3/8" Double Drive Ratchet
- 1 3/8"Dr. Quick Release Ratchet



1/2 Tray 4700g 3 Sets / 16.0 Kgs / 1.35 CUFT

MS-435M 35pcs 1/2" Dr. Metric Deep Hand Socket Set

- 15 1/2"Dr. 12pt. Hand Socket
10 - 12 - 13 - 14 - 15 - 16 - 17 - 18 - 19 - 21 -
22 - 24 - 27 - 30 - 32mm
- 15 1/2"Dr. 6pt. Deep Hand Socket
10 - 12 - 13 - 14 - 15 - 16 - 17 - 18 - 19 - 21 -
22 - 24 - 27 - 30 - 32mm
- 4 1/2"Dr. Wbble Extension Bars
50 - 75 - 125 - 250mmL
- 1 1/2"Dr. Universal Joint



1/2 Tray 5900g 3 Sets / 19.5 Kgs / 1.35 CUFT

MS-437M 37pcs 1/2" Dr. Metric Hand Socket Set

- 19 1/2"Dr. Hand Socket
8 - 9 - 10 - 11 - 12 - 13 - 14 - 15 - 16 - 17 - 18 -
19 - 21 - 22 - 24 - 27 - 30 - 32 - 36mm
- 9 1/2"Dr. E-Star Hand Socket
E10 - 11 - 12 - 14 - 16 - 18 - 20 - 22 - 24
- 2 1/2"Dr. Adapter - Universal Joint
- 2 1/2"Dr. Spark Plug 16mm - 20.6mm
- 3 1/2"Dr. Ext. 50 - 125 - 250mmL
- 1 1/2"Dr. Hinge Handle 410mmL
- 1 1/2"Dr. Quick Release Ratchet



1/2 Tray 5700g 3 Sets / 19 Kgs / 1.35 CUFT

1/2 Tray Sets

MS-442B 42pcs 1/2" Dr. Complete Bit Socket Set **NEW**

- 16 1/2"Dr. Hex Bit Socket
5 - 6 - 7 - 8 - 9 - 10 - 12mm (55mmL)
14 - 17 - 19mm (80mmL)
5 - 6 - 7 - 8 - 10 - 12mm (110mmL)
- 14 1/2"Dr. Star Bit Socket
T30 - 40 - 45 - 50 - 55 (55mmL)
T60 - 70 (60mmL)
T30 - 40 - 45 - 50 - 55 - 60 - 70 (110mmL)
- 12 1/2"Dr. Triple Square Bit Socket
M6 - 8 - 10 - 12 - 14 (55mmL) - 16 - 18 (60mmL)
M8 - 10 - 12 - 14 - 16 (110mmL)



1/2 Tray 5100g 3 Sets / 17 Kgs / 1.35 CUFT

MS-057M 57pcs 1/4" & 1/2" Dr. Swivel Socket & Bit Socket Set

- 16 1/4"Dr. Star Hand Socket E4 - 5 - 6 - 7 - 8 - 10 - 11
1/2"Dr. Star Hand Socket E10 - 11 - 12 - 14 - 16 -
18 - 20 - 22 - 24
- 9 1/4"Dr. Universal Hand Socket 6 - 7 - 8 - 9 - 10 -
11 - 12 - 13 - 14mm
- 11 1/2"Dr. Swivel Impact Socket 11 - 12 - 13 - 14 -
15 - 16 - 17 - 18 - 19 - 21 - 22mm
- 10 1/2"Dr. Tamperproof Star Bit Socket T20 - 25 -
27 - 30 - 40 - 45 - 50 - 55 - 60 - 70 (80mmL)
- 9 1/2"Dr. Triple Square Bit Socket
M4 - 5 - 6 - 8 - 10 - 12 - 14 - 16 - 18 (80mmL)
- 2 1/4" Dr. & 1/2"Dr. Rotor Ratchet



1/2 Tray 6820g 3 Sets / 22.5 Kgs / 1.35 CUFT

MS-020M 20pcs Metric Combination Wrench Set

- 20 Combination Wrench (748206 ~ 748232)
6 - 7 - 8 - 9 - 10 - 11 - 12 - 13 - 14 - 15 - 16 -
17 - 18 - 19 - 21 - 22 - 24 - 27 - 30 - 32mm



1/2 Tray 4800g 3 Sets / 16.5 Kgs / 1.35 CUFT

MS-020B 20pcs Metric Box End, Open End & E-Star Wrench Set

- 8 Box End Wrench (740607 ~ 742022)
6x7 - 8x9 - 10x11 - 12x13 - 14x15 - 16x17 -
18x19 - 20x22mm
- 8 Open End Wrench (790607 ~ 792022)
6x7 - 8x9 - 10x11 - 12x13 - 14x15 - 16x17 -
18x19 - 20x22mm
- 4 E-Star Wrench (790608 ~ 792024)
E6x8 - 10x12 - 14x18 - 20x24



1/2 Tray 2700g 3 Sets / 9 Kgs / 1.35 CUFT

MS-024M 24pcs Metric Combination & Box End Wrench Set

- 16 Combination Wrench (748206 ~ 748222)
6 - 7 - 8 - 9 - 10 - 11 - 12 - 13 - 14 - 15 - 16 -
17 - 18 - 19 - 21 - 22mm
- 8 Box End Wrench (740607 ~ 742022)
6x7 - 8x9 - 10x11 - 12x13 - 14x15 - 16x17 -
18x19 - 20x22mm



1/2 Tray 3600g 3 Sets / 12.5 Kgs / 1.35 CUFT

1/3 Tray Sets

MS-035M 35pcs Metric Flare Nut & L-Shaped Key Wrench Set

- 6 Flare Nut Wrench (740911 ~ 741921)
9x11 - 10x12 - 13x14 - 15x17 - 16x18 - 19x21mm
- 12 Long Hex Key Wrench 6 - 7 - 8 - 9 - 10 - 11 - 12 - 13 - 14 - 16 - 17 - 19mm
- 7 Triple Square Key Wrench
M5 - 6 - 8 - 10 - 12 - 14 - 16
- 6 Screw Extractor
#1 - 2 - 3 - 4 - 5 - 6
- 4 1/2" Dr. Stud Remover Socket
6 - 8 - 10 - 12mm



1/2 Tray 7040g 3 Sets / 22.5 Kgs / 1.35 CUFT

MS-028S 28pcs SAE Flare Nut, E-Star & L-Shaped Key Wrench

- 5 Flare Nut Wrench (760810 ~ 762428) 1/4x5/16 - 3/8x7/16 - 1/2x9/16 - 5/8x11/16 - 3/4x7/8"
- 4 E-Star Wrench (790608 ~ 792024)
E6x8 - 10x12 - 14x18 - 20x24mm
- 8 Long Hex Key Wrench
1/4 - 5/16 - 3/8 - 7/16 - 1/2 - 9/16 - 5/8 - 3/4"
- 5 Offset Screwdriver
Slotted 6.0 - 8.0 - 9.0mm & Philips #1x2 - 3x4
- 4 1/2" Dr. Stud Remover Socket
1/4 - 5/16 - 3/8 - 7/16"
- 2 Pick-up Tool (330~685mmL) & Hinged Mirror (50x90mm)



1/2 Tray 5520g 3 Sets / 18 Kgs / 1.35 CUFT

MS-013SP 13pcs Slotted & Philips Screwdriver Set

- 7 Slotted Screwdriver
3.0x155 - 4.0x180 - 5.0x330 - 6.0x250 - 6.5x250 - 8.0x300 - 6.x98mmL
- 5 Philips Screwdriver
#0x155 - 1x170 - 2x200 - 3x270 - 2x98mmL
- 1 Pry Bar
300mmL (12"L)



1/2 Tray 1500g 3 Sets / 6.3 Kgs / 1.35 CUFT

MS-014 14pcs Slotted, Philips & Posidriv Screwdriver Set

- 4 Slotted Screwdriver
10x370 - 12x320 - 14x370 - 6.5x98mmL
- 6 Philips Screwdriver
#2x300 - 3x245 - 3x390 - 4x320 - 1x98 - 2x98mmL
- 4 Posidriv Screwdriver
#3x295 - 4x340 - 1x98 - 2x98mmL



1/2 Tray 2720g 3 Sets / 9.5 Kgs / 1.35 CUFT

MS-013T 13pcs Star Screwdriver Set

- 13 Star Screwdriver
T6x150 - T7x150 - T8x150 - T9x150 - T10x185 - T15x185 - T20x185 - T25x185 - T27x225 - T30x225 - T40x235 - T45x235 - T50x235mmL



1/2 Tray 1500g 3 Sets / 6.3 Kgs / 1.35 CUFT

1/2 Tray Sets

MS-025R 25pcs Hex Screwdriver & Ratcheting Screwdriver Set

- 8 Hex Screwdriver
2x150 - 2.5x150 - 3x150 - 4x170 - 5x185 - 6x185 - 7x235 - 8x235mmL
- 11 1/4" Hex Shank Nut Driver
- 4 Flexible Bit Holder - Magnetic Bit Holder Adapter - Socket Holder Adapter - Spinner Handle
- 1 1/4" Hex Shank Standard Ratcheting Screwdriver
- 1 1/4" Hex Shank T-Handle Ratcheting Screwdriver



1/2 Tray 2000g 3 Sets / 7.8 Kgs / 1.35 CUFT

MS-013 13pcs Tang-Thru Screwdriver, Pry Bar & Carbon Scraper

- 2 Slotted Tang-Thru Screwdriver
6.5x245 - 14x365mmL
- 2 Philips Tang-Thru Screwdriver
#1x220 - 4x305mmL
- 4 Posidriv Tang-Thru Screwdriver
#1x200 - 2x245 - 3x270 - 4x320mmL
- 3 Rigid Carbon Scraper
12x250 - 26x200 - 26x300mmL
- 2 Pry Bar
200mmL (8"L) - 300mmL (12"L)

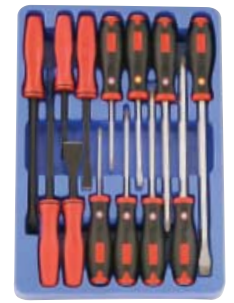

1/2 Tray 2920g 3 Sets / 10 Kgs / 1.35 CUFT

MS-048MS 48pcs Hex, Star, Triple Square & Square Bit Set

- 13 Hex Bit 3 - 4 - 5 - 6 - 7 - 8mm (160mmL)
1/8 - 5/32 - 3/16 - 7/32 - 1/4 - 9/32 - 5/16" (160mmL)
- 13 Wobble Hex Bit 3 - 4 - 5 - 6 - 7 - 8mm (160mmL)
1/8 - 5/32 - 3/16 - 7/32 - 1/4 - 9/32 - 5/16" (160mmL)
- 12 Tamperproof Star Bit T7 - 8 - 9 - 10 - 15 - 20 - 25 - 27 - 30 - 40 - 45 - 50 (160mmL)
- 4 Triple Square Bit M4 - 5 - 6 - 8 (160mmL)
- 5 Square Bit #0 - 1 - 2 - 3 - 4 (160mmL)
- 1 1/4" & 5/16" Hex Shank OMNIDRIVE 3in1 Handgrip

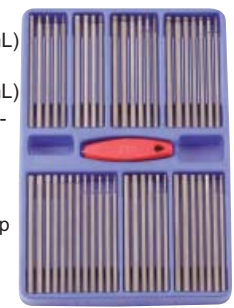

1/2 Tray 2640g 3 Sets / 9 Kgs / 1.35 CUFT

MS-019 19pcs Punch, Chisel & Hammer Set

- 5 Flat Chisel
6 - 10 - 14 - 19 - 25mm
- 6 Pin Punch
2 - 3 - 4 - 5 - 6 - 8mm
- 1 Center Punch
4mm
- 5 Taper Bit Extractor
3 - 5 - 6 - 8 - 9mm
- 1 Ball Peen Hammer 1 lbs. (454 g)
- 1 Drilling Hammer 2 1/2 lbs. (1135 g)



1/2 Tray 3900g 3 Sets / 13.5 Kgs / 1.35 CUFT

MS-007P 7pcs Pliers Set

- 1 Water Pump Pliers 250mmL (10"L)
- 1 Bent Nose Pliers 200mmL (8"L)
- 1 Chain Nose Pliers with Cutter 200mmL (8"L)
- 1 Side Cutter Pliers 180mmL (7"L)
- 1 Heavy Duty Diagonal Cutting Pliers 180mmL (7"L)
- 1 Curved Jaw Locking Pliers with Cutter
250mmL (10"L)
- 1 Long Nose Locking Pliers with Cutter
150mmL (6"L)



1/2 Tray 2500g 3 Sets / 9.3 Kgs / 1.35 CUFT

Tool Trays

1/2 Tray Sets

MS-008R 8pcs Retaining Ring Pliers & Oil Filter Wrench Set **NEW**

- 1 Straight Nose, External Retaining Ring Pliers
- 1 Straight Nose, Internal Retaining Ring Pliers
- 1 90° Bent Nose, External Retaining Ring Pliers
- 1 90° Bent Nose, Internal Retaining Ring Pliers
- 3 Oil Filter Wrench
60~73mm (2-3/8 ~ 2-7/8") -
73~85mm (2-7/8 ~ 3-3/8") -
85~95mm (3-3/8 ~ 3-3/4")
- 1 Oil Filter Pliers 50 ~ 115mm (2" ~ 4-1/2")

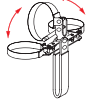

1/2 Tray 2100g 3 Sets / 8.1 Kgs / 1.35 CUFT

MS-014A 14pcs Combination Auto Repair Tool Kit **NEW**

- 4 Miniature Pick
Awl - Hook - Bent Tip 45° - Bent Tip 90°
- 2 O-Ring Oil Seal Pick
Hook & O-Ring 90° Tip (double end)
Bent Tip 90° & Bent Tip 45° (double end)
- 2 Carbon Scraper
12mm x 250mmL & 26mm x 300mmL
- 1 Trim Pad Remover 230mmL (9.1"L)
- 1 Brake Spring Pliers 330mmL (13"L)
- 1 Magnetic Pick-up Tool 135 ~ 645mmL
- 1 Hinged Mirror 57mm Diameter
- 2 Heater Hose Clamp Pliers

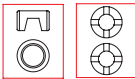

1/2 Tray 1800g 3 Sets / 7.2 Kgs / 1.35 CUFT

2/3 Tray Sets

TL-518 18pcs Slotted & Philips Screwdriver Set

- 5 Slotted: 5.0x345 -
6.5x195 - 10.0x310 -
10.0x360 - 6.5x86mmL
- 7 Philips: #1x170 - #1x345 -
#2x140 - #2x295 - #2x395 -
#3x310 - #1x86mmL
- 3 Micro-Tech Slotted:
2.0 - 2.5 - 3.0mm
- 3 Micro-Tech Philips:
#000 - #00 - #0



2/3 Tray 2360g 10 Sets / 24.5 Kgs / 3.60 CUFT

CP-5312 12pcs Locking Pliers Set

- 3 Curved Jaw Locking Pliers w/ Cutters:
5" - 7" - 10"
- 2 Long Nose Locking Pliers w/ Cutter:
6" - 9"
- 2 Straight Jaw Locking Pliers: 7" - 10"
- 2 Locking "C" Clamps: 6" - 11"
- 1 Water Pump Pliers: 10"
- 1 Chain Nose Pliers w/ Cutter: 8"
- 1 Heavy Duty Diagonal Cutting Pliers: 8"



2/3 Tray 5400g 5 Sets / 28 Kgs / 1.58 CUFT

Full Tray Sets

MS-106M 106pcs 3/8"Dr. Metric Tool Set

- 17 3/8"Dr. 6pt. Hand Socket 6 ~ 22mm
- 17 3/8"Dr. Deep Hand Socket
6 ~ 22mm
- 10 3/8"Dr. 12pt. Universal Socket
10 ~ 19mm
- 16 3/8"Dr. Impact Socket 7 ~ 22mm
- 5 3/8"Dr. Slotted Bit Socket
4 ~ 9mm(50mmL)
- 4 3/8"Dr. Philips Bit Socket
#1 ~ 4(50mmL)
- 20 3/8"Dr. Hex Bit Socket 3 ~ 12mm(50 & 140mmL)
- 1 3/8"Dr. Universal Joint
- 10 3/8"Dr. Star Bit Socket T10 ~ 55mm(50mmL)
- 1 3/8"Dr. Sliding T-Handle
- 2 3/8"Dr. Adapter 1/4"M & 1/2"M
- 2 3/8"Dr. Ext 45 & 150mmL
- 1 3/8"Dr. Quick Release Ratchet



Full Tray 7600g 2 Sets / 17.2 Kgs / 1.76 CUFT

MS-090S 90pcs 3/8"Dr. SAE Tool Set

- 14 3/8"Dr. 6pt. Hand Socket 1/4 ~ 7/8"
- 14 3/8"Dr. Deep Hand Socket
14 ~ 7/8"
- 7 3/8"Dr. 12pt. Universal Socket
3/8 ~ 3/4"
- 13 3/8"Dr. Dep Impact Socket
5/16 ~ 7/8"
- 20 3/8"Dr. Hex Bit Socket
1/8 ~ 1/2"(50 & 140mmL)
- 10 3/8"Dr. Star Bit Socket T10 ~ 55mm(140mmL)
- 2 3/8"Dr. Ext. 3 - 7 7/8"L
- 7 3/8"Dr. Triple Square M4 ~ 14(50mmL)
- 1 3/8"Dr. Hinge Handle
- 1 3/8"Dr. 72 Teeth Rotor Ratchet
- 1 3/8"Dr. 72 Teeth Reversible Ratchet



Full Tray 8300g 2 Sets / 18.6 Kgs / 1.76 CUFT

MS-098M 98pcs 1/4" & 1/2"Dr. Metric Tool Set

- 11 1/4"Dr. Hand Socket 5 ~ 14mm
- 12 1/4"Dr. Deep Hand Socket
4 ~ 14mm
- 18 1/2"Dr. 12pt. Hand Socket
8 ~ 32mm
- 14 1/2"Dr. Impact Socket 10 ~ 24mm
- 3 1/2"Dr. Deep Impact Socket
17 ~ 21mm
- 5 Ext. 1/4"Dr. 50 - 100 - 150mmL
1/2"Dr. 125 - 250mmL
- 7 Hex Bit Socket 1/4"Dr. 3 ~ 5mm(45mmL) & 1/2"Dr. 6 ~ 12mm(80mmL)
- 7 Star Bit Socket 1/4"Dr. T20 ~ 30mm(45mmL) & 1/2"Dr. T40 ~ 55mm(80mmL)
- 2 1/4" & 1/2"Dr. Universal Joint
- 2 1/4" & 1/2"Dr. Sliding T-Handle
- 2 1/4" & 1/2"Dr. Quick Release Ratchet
- 1 1/4" Socket Driver
- 7 Box End Wrench 6x7 ~ 18x19mm
- 7 Open End Wrench 6x7 ~ 18x19mm



Full Tray 9800g 2 Sets / 21.6 Kgs / 1.76 CUFT

MS-100S 100pcs 1/4" & 1/2"Dr. SAE Tool Set

- 10 1/4"Dr. Hand Socket 3/16 ~ 9/16"
- 10 1/4"Dr. Deep Hand Socket
3/16 ~ 9/16"
- 6 1/4"Dr. 12pt. Universal Socket
1/4 ~ 9/16"
- 18 1/2"Dr. 12pt. Hand Socket
5/16 ~ 1 1/4"
- 9 1/2"Dr. Deep Hand Socket 1/2 ~ 1"
- 13 1/2"Dr. Impact Socket 3/8 ~ 1"
- 3 1/2"Dr. Deep Impact Skt 3/4 ~ 7/8"
- 9 Hex Bit Socket 1/4"Dr. 1/8 ~ 7/32"(45mmL) & 1/2"Dr. 1/4 ~ 1/2"(80mmL)
- 2 1/2"Dr. Spark Plug 5/8" - 13/16"
- 9 Wobble Hex Key 1/16" - 3/8"
- 6 Box End Wrench 1/4x5/16 ~ 7/8x15/16"
- 5 Open End Wrench 1/4x5/16 ~ 3/4x7/8"



Full Tray 10300g 2 Sets / 22.6 Kgs / 1.76 CUFT

Full Tray Sets

MS-086 86pcs Screwdriver & Bit Set

- 4 Slotted Screwdriver 5.5 ~ 10mm
- 2 Philips Screwdriver #1 ~ 2
- 2 Posidriv Screwdriver #1 ~ 2
- 10 Tamperproof Star Screwdriver T8 ~ 50
- 6 Slotted Bit 3 ~ 7mm
- 4 Philips Bit #0 ~ 3
- 19 Hex Bit 2 ~ 8mm & 1/16 ~ 5/16"
- 11 Star Bit T6 ~ 40
- 3 Triple Square Bit M4 ~ 6
- 9 Wobble Hex Key 1.5 ~ 10mm
- 2 Flexible & Magnetic Bit
- 3 Ratcheting Screwdriver Standard - Stubby - T Handle



- 10 Tamperproof Star Key T9 ~ 50
- 1 Socket Holder Adapter

Full Tray
 4200g 2 Sets / 10.4 Kgs / 1.76 CUFT

MS-044M 44pcs Metric Complete Wrench Set

- 10 Stubby Ratcheting Wrench 10 - 11 - 12 - 13 - 14 - 15 - 16 - 17 - 18 - 19mm
- 26 Combination Wrench 6 - 7 - 8 - 9 - 10 - 11 - 12 - 13 - 14 - 15 - 16 - 17 - 18 - 19 - 20 - 21 - 22 - 23 - 24 - 25 - 26 - 27 - 28 - 29 - 30 - 32mm
- 8 Extra Long Box End Wrench 8x10 - 10x12 - 12x14 - 13x15 - 14x17 - 16x18 - 17x19 - 22x24mm



Full Tray
 10700g 2 Sets / 23.4 Kgs / 1.76 CUFT

MS-035S 35pcs SAE Complete Wrench Set

- 7 Stubby Ratcheting Wrench 3/8 - 7/16 - 1/2 - 9/16 - 5/8 - 11/16 - 3/4"
- 8 Ratcheting Wrench 5/16 - 3/8 - 7/16 - 1/2 - 9/16 - 5/8 - 11/16 - 3/4"
- 16 Combination Wrench 1/4 - 5/16 - 3/8 - 7/16 - 1/2 - 9/16 - 5/8 - 11/16 - 3/4 - 13/16 - 7/8 - 15/16 - 1" - 1 1/16 - 1 1/8 - 1 1/4"
- 4 Extra Long Box End Wrench 5/16x3/8 - 7/16x1/2 - 9/16x5/8 - 11/16x3/4"



Full Tray
 7400g 2 Sets / 16.8 Kgs / 1.76 CUFT

MS-041MS 41pcs Metric & SAE Combination & Flare Nut Wrench

- 18 Metric Combination Wrench 6 - 7 - 8 - 9 - 10 - 11 - 12 - 13 - 14 - 15 - 16 - 17 - 18 - 19 - 21 - 22 - 23 - 24mm
- 12 SAE Combination Wrench 1/4 - 5/16 - 3/8 - 7/16 - 1/2 - 9/16 - 5/8 - 11/16 - 3/4 - 13/16 - 7/8 - 15/16"
- 6 Metric Flare Nut Wrench 9x11 - 10x12 - 13x14 - 15x17 - 16x18 - 19x21mm
- 5 SAE Flare Nut Wrench 1/4x5/16 - 3/8x7/16 - 1/2x9/16 - 5/8x11/16 - 3/4x7/8"



NEW

Full Tray
 6500g 2 Sets / 15.5 Kgs / 1.76 CUFT

Full Tray Sets

MS-023 23pcs Punch, Chisel & Hammer Set

- 9 Punch Pin 2 - 3 - 4 - 5 - 6mm Center 3 - 5mm Line Up 3 - 5mm
- 5 Flat Chisel 6 - 10 - 12 - 14 - 16mm
- 2 Slotted Tang-Thru Screwdriver 10 - 12mm
- 2 Philips Tang-Thru Screwdriver #2 - 3
- 4 Claw Hammer - Ball Peen Hammer - Drilling Hammer - Soft Face Hammer
- 1 Close Quarter Bar 460mmL (18"L)



Full Tray
 6700g 2 Sets / 15.4 Kgs / 1.76 CUFT

MS-015 15pcs Pliers Set

- 3 Locking Pliers Curved Jaw 250mmL (10"L) Long Nose 230mmL (9"L) C-Clamp 150mmL (6"L)
- 5 Pliers Side Cutter 180mmL (7"L) Chain Nose 150mmL (6"L) Diagonal Cutting 150mmL (6"L) Water Pump 250mmL (10"L) Combination Slip Joint 200mmL (8"L)
- 4 Retaining Ring Pliers Straight Nose Ext./Int. & 90° Bent Nose Ext./Int.
- 3 Adjustable Wrench 200mmL (8"L) - Heavy Duty Pipe Wrench 300mmL (12"L) Straight Tip Aviation Snip 250mmL (10"L)



Full Tray
 5500g 2 Sets / 13 Kgs / 1.76 CUFT

MS-035MS 35pcs Pliers & Screwdriver Set

- 1 Curved Jaw Locking Plier w/ Cutter 180mmL (7"L)
- 4 Pliers Side Cutter 180mmL (7"L) Chain Nose 150mmL (6"L) Diagonal Cutting 150mmL (6"L) Water Pump 250mmL (10"L)
- 1 Adjustable Wrench 24mm Jaw
- 1 Ball Peen Hammer 3/4 lbs.
- 18 Wobble Hex Key 1.5 ~ 10mm & 1/16 ~ 3/8"
- 4 Slotted Screwdriver 3.0 ~ 6.5mm
- 4 Philips Screwdriver #0 ~ 2
- 2 Slotted & Philips Tang-Thru Screwdriver 6.5mm & #3



Full Tray
 4500g 2 Sets / 11.5 Kgs / 1.76 CUFT

MS-139MS* 139pcs 1/4", 3/8" & 1/2" Dr. Metric & SAE Tool Set

- 19 1/4"Dr. 12pt. Hand Socket 6 ~ 22mm & 3/16 ~ 1/2"
- 15 1/4"Dr. 12pt. Universal Hand Socket 6 ~ 14mm & 1/4 ~ 9/16"
- 16 1/4"Dr. Hex Head Socket 3 ~ 10mm & 1/8 ~ 3/8"
- 22 3/8"Dr. 12pt. Hand Socket 8 ~ 19mm & 5/16 ~ 3/4"
- 17 3/8"Dr. 12pt. Universal Hand Socket 10 ~ 19mm & 3/8 ~ 3/4"
- 31 1/2"Dr. 12pt. Hand Socket 10 ~ 32mm & 3/8 ~ 1 1/4"
- 6 Extension 1/4"Dr. 50 - 100mmL 3/8"Dr. 75 - 150mmL 1/2"Dr. 125 - 250mmL
- 3 1/4" - 3/8" - 1/2"Dr. Hinge Handle
- 3 1/4" - 3/8" - 1/2"Dr. Quick Release Ratchet
- 3 1/4" - 3/8" - 1/2"Dr. Universal Joint
- 1 1/4"Dr. Socket Driver
- 1 3/8"Dr. Adapter 1/4"M
- 2 3/8"Dr. Spark Plug 16mm (5/8") & 20.6mm (13/16")

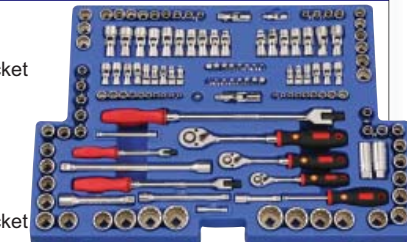

Full Tray
 10500g 3 Sets / 35.5 Kgs / 2.70 CUFT

NEW

*MS-139MS specially designed for fitting in top chests TS-244 or TS-790

Master Sets

Master Tool Sets

MS-142TS 142pcs 1/4" & 1/2" Dr. Metric Mechanic Tool Set



- | | | | |
|-------------------------------------|------------------------------------|--|--|
| 14 1/4"Dr. Hand Socket 3 ~ 14mm | 11 Star Bit T6 ~ 40 | 1 1/4"Dr. Flexible Spinner | |
| 5 1/4"Dr. Deep Hand Socket 6 ~ 13mm | 11 Tamperproof Star Bit T7 ~ 45 | 1 1/4"Dr. Socket Driver | |
| 14 1/2"Dr. Hand Socket 8 ~ 24mm | 3 Triple Square Bit M4 ~ 6 | 2 1/4" & 1/2"Dr. Reversible Ratchet | |
| 17 Combination Wrench 6 ~ 24mm | 1 Socket Holder Adapter | 9 Wobble Hex Key 1.5 ~ 10mm | |
| 4 Slotted Screwdriver 3.0 ~ 6.5mm | 1 1/4" Hex Shank Bit Holder | 10 Tamperproof Star Key T9 ~ 50 | |
| 3 Philips Screwdriver #1 ~ 2 | 2 1/4" & 1/2"Dr. Universal Joint | 3 Pin Punch 3 - 5mm & Flat Chisel 19mm | |
| 6 Slotted Bit 3.0 ~ 7.0mm | 2 1/2"Dr. Spark Plug 16mm - 20.6mm | 1 12" Ball Peen Hammer | |
| 4 Philips Bit #0 ~ 3 | 4 1/4" & 1/2"Dr. Extension Bar | | |
| 8 Hex Bit #2 ~ 8mm | 50 - 75 - 100 - 250mmL | | |
| | | 5 6" Chain Nose Pliers w/ Cutter | |
| | | 6" Diagonal Cutting Pliers | |
| | | 7" Side Cutter Pliers | |
| | | 10" Water Pump Pliers | |
| | | 7" Curved Jaw Locking Pliers w/ Cutter | |
- 1 **TS-125** 5 Tier Portable Tool Chest
 17 kgs

MS-110TS 110pcs 1/4", 3/8" & 1/2" Dr. Metric Mechanic Tool Set

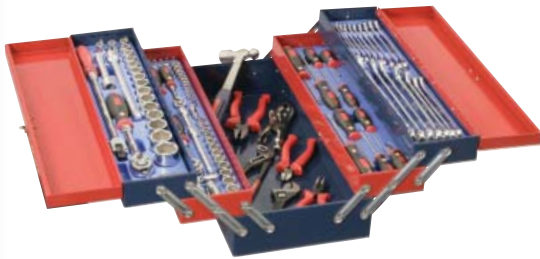

- | | | | |
|---------------------------------------|--|--|----------------------------------|
| 11 1/4"Dr. Hand Socket 3 ~ 13mm | 9 Wobble Hex Key 1.5 ~ 10mm | | |
| 8 1/4"Dr. Hex Head Socket 3 ~ 10mm | 3 1/4", 3/8" & 1/2"Dr. Universal Joint | | |
| 12 3/8"Dr. Hand Socket 8 ~ 19mm | 2 3/8"Dr. Spark Plug 16mm - 20.6mm | | |
| 17 1/2"Dr. Hand Socket 10 ~ 32mm | 6 1/4", 3/8" & 1/2"Dr. Ext. | | |
| 18 Combination Wrench 6 ~ 24mm | 50 - 75 - 100 - 125 - 150 - 250mmL | | |
| 4 Slotted Screwdriver 3.0 ~ 6.5mm | 1 1/4"Dr. Socket Driver | | |
| 4 Philips Screwdriver #0 ~ 2 | 3 1/4", 3/8" & 1/2"Dr. Hinge Handle | | |
| 1 Slotted Tang-Thru Screwdriver 6.5mm | 3 1/4", 3/8" & 1/2"Dr. Quick Release Ratchet | | |
| 1 Philips Tang-Thru Screwdriver #1 | 1 8" Adjustable Wrench | | |
| | 1 12" Ball Peen Hammer | | |
| | | | 5 6" Chain Nose Pliers w/ Cutter |
| | | | 6" Diagonal Cutting Pliers |
| | | | 7" Side Cutter Pliers |
| | | | 10" Water Pump Pliers |
| | | 7" Curved Jaw Locking Pliers w/ Cutter | |
- 1 **TS-125** 5 Tier Portable Tool Chest
 19.5 kgs

MS-190TS 190pcs 1/4", 3/8" & 1/2" Dr. Metric & SAE Mechanic Tool Set

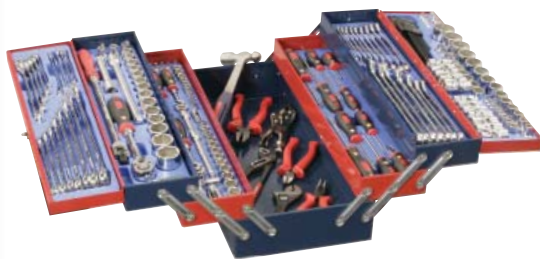

- | | | | |
|--|--|--|----------------------------------|
| 20 1/4"Dr. Hand Socket 4 ~ 13mm & 3/16 ~ 1/2" | 5 Flare Nut Wrench 1/4x5/16 ~ 3/4x7/8" | | |
| 6 1/4"Dr. 12pt. Universal Socket 1/4 ~ 9/16" | 8 Screwdriver Slotted 3.0 ~ 6.5mm & Philips #0 ~ 2 | | |
| 16 1/4"Dr. Hex Head Socket 3 ~ 10mm & 1/8 ~ 3/8" | 2 Tang-Thru Screwdriver Slotted 6.5mm & Philips #1 | | |
| 22 3/8"Dr. Hand Socket 8 ~ 19mm(6pt.) & 5/16 ~ 3/4"(12pt.) | 18 Wobble Hex Key 1.5 ~ 10mm & 1/16 ~ 3/8" | | |
| 7 3/8"Dr. 12pt. Universal Socket 3/8 ~ 3/4" | 3 1/4", 3/8" & 1/2"Dr. Universal Joint | | |
| 31 1/2"Dr. Hand Socket 10 ~ 32mm(6pt.) & 3/8 ~ 1 1/4"(12pt.) | 2 3/8"Dr. Spark Plug 16mm - 20.6mm | | |
| 30 Combination Wrench 6 ~ 24mm & 1/4 ~ 15/16" | 6 1/4", 3/8" & 1/2"Dr. Ext. | | |
| | 50 - 75 - 100 - 125 - 150 - 250mmL | | |
| | 1 1/4"Dr. Socket Driver | | |
| | 3 1/4", 3/8" & 1/2"Dr. Hinge Handle | | |
| | 3 1/4", 3/8" & 1/2"Dr. Quick Release Ratchet | | |
| | | | 5 6" Chain Nose Pliers w/ Cutter |
| | | | 6" Diagonal Cutting Pliers |
| | | | 7" Side Cutter Pliers |
| | | 10" Water Pump Pliers | |
| | | 7" Curved Jaw Locking Pliers w/ Cutter | |
| | | 1 12" Ball Peen Hammer | |
| | | 1 8" Adjustable Wrench | |
- 1 **TS-125** 5 Tier Portable Tool Chest
 25.5 kgs

Master Tool Sets

MS-236TS 236pcs 3/8" Dr. Metric Mechanic Tool Set

- 1 **MS-106M** 106pcs 3/8"Dr. Metric Tool Set
- 1 **MS-044M** 44pcs Metric Complete Wrench Set
- 1 **MS-086** 86pcs Screwdriver & Bit Set
- 1 **TS-465P** 5 Drawer Roller Cabinet w/ Inter Lock System

81 kgs



Master Tool Sets

MS-361TS 361pcs 3/8" Dr. Metric & SAE Mechanic Tool Set

- 1 **MS-106M** 106pcs 3/8"Dr. Metric Tool Set
- 1 **MS-090S** 90pcs 3/8"Dr. SAE Tool Set
- 1 **MS-044M** 44pcs Metric Complete Wrench Set
- 1 **MS-035S** 35pcs SAE Complete Wrench Set
- 1 **MS-086** 86pcs Screwdriver & Bit Set
- 1 **TS-798** 7 Drawer Roller Cabinet

102 kgs



MS-266TS 266pcs 1/4" & 1/2" Dr. Metric Mechanic Tool Set

- 1 **MS-098M** 98pcs 1/4" & 1/2"Dr. Metric Tool Set
- 1 **MS-044M** 44pcs Metric Complete Wrench Set
- 1 **MS-086** 86pcs Screwdriver & Bit Set
- 1 **MS-023** 23pcs Punch, Chisel & Hammer Set
- 1 **MS-015** 15pcs Pliers Set
- 1 **TS-467P** 7 Drawer Roller Cabinet w/ Inter Lock System

107 kgs



MS-322TS 322pcs 1/4" & 1/2" Dr. Metric & SAE Mechanic Tool Set

- 1 **MS-098M** 98pcs 1/4" & 1/2"Dr. Metric Tool Set
- 1 **MS-100S** 100pcs 1/4" & 1/2"Dr. SAE Tool Set
- 1 **MS-086** 86pcs Screwdriver & Bit Set
- 1 **MS-023** 23pcs Punch, Chisel & Hammer Set
- 1 **MS-015** 15pcs Pliers Set
- 1 **TS-467P** 7 Drawer Roller Cabinet w/ Inter Lock System

107 kgs



Master Sets

Master Tool Sets

- MS-548TS 548pcs 1/4" & 1/2" Dr. Metric & SAE Master Tool Set**
- 1 **MS-098M** 98pcs 1/4" & 1/2" Dr. Metric Tool Set
 - 1 **MS-100S** 100pcs 1/4" & 1/2" Dr. SAE Tool Set
 - 1 **MS-044M** 44pcs Metric Complete Wrench Set
 - 1 **MS-035S** 35pcs SAE Complete Wrench Set
 - 1 **MS-086** 86pcs Screwdriver & Bit Set
 - 1 **MS-023** 23pcs Punch, Chisel & Hammer Set
 - 1 **MS-015** 15pcs Pliers Set
 - 1 **MS-057M** 57pcs 1/4" & 1/2" Dr. Swivel Socket & Bit Socket Set
 - 1 **MS-035M** 35pcs Metric Flare Nut & L-Shaped Key Wrench Set
 - 1 **MS-014** 14pcs Slotted, Philips & Posidriv Screwdriver Set
 - 1 **MS-013** 13pcs Tang-Thru Screwdriver, Pry Bar & Carbon Scraper
 - 1 **MS-028S** 28pcs SAE Flare Nut, E-Star & L-Shaped Key Wrench
 - 1 **TS-790** 10 Drawer Top Tool Chest
 - 1 **TS-797** 7 Drawer Side Cabinet
 - 1 **TS-798** 7 Drawer Roller Cabinet

233 kgs

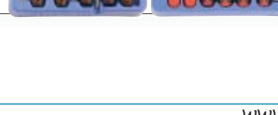
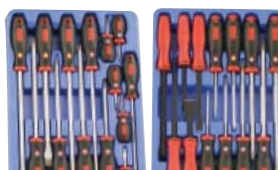

Master Tool Sets

- MS-926TS 926pcs 1/4" 3/8" & 1/2" Dr. Metric & SAE Master Tool Set**
- 1 **MS-098M** 98pcs 1/4" & 1/2" Dr. Metric Tool Set
 - 1 **MS-100S** 100pcs 1/4" & 1/2" Dr. SAE Tool Set
 - 1 **MS-106M** 106pcs 3/8" Dr. Metric Tool Set
 - 1 **MS-090S** 90pcs 3/8" Dr. SAE Tool Set
 - 1 **MS-044M** 44pcs Metric Complete Wrench Set
 - 1 **MS-035S** 35pcs SAE Complete Wrench Set
 - 1 **MS-086** 86pcs Screwdriver & Bit Set
 - 1 **MS-023** 23pcs Punch, Chisel & Hammer Set
 - 1 **MS-015** 15pcs Pliers Set
 - 1 **MS-057M** 57pcs 1/4" & 1/2" Dr. Swivel Socket & Bit Socket Set
 - 1 **MS-027S** 27pcs 1/2" Dr. SAE Impact Socket & Accessory Set
 - 1 **MS-042M** 42pcs 3/8" Dr. Metric Impact Socket & Star Socket Set
 - 1 **MS-065S** 65pcs 3/8" Dr. Head Driver & Impact Socket Set
 - 1 **MS-035M** 35pcs Metric Flare Nut & L-Shaped Key Wrench Set
 - 1 **MS-028S** 28pcs SAE Flare Nut, E-Star & Key Wrench Set
 - 1 **MS-014** 14pcs Slotted, Philips & Posidriv Screwdriver Set
 - 1 **MS-013** 13pcs Tang-Thru Screwdriver, Pry Bar & Carbon Scraper Set
 - 1 **MS-048MS** 48pcs Hex, Star, Triple Square & Square Bit Set
 - 1 **TS-246** 6 Drawer Jumbo Top Chest
 - 1 **TS-468** 7 Drawer Jumbo Roller Cabinet

263 kgs

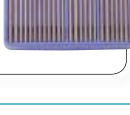
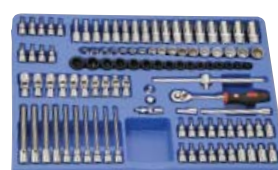

Master Tool Sets

MS-771 771pcs 1/4" 3/8" & 1/2" Dr. Metric & SAE Master Tool Set (without tool cabinet & tool chest)

Item No.	Piece	Description	Item No.	Piece	Description
TF-255MS	55	1/4" Dr. 6pt. Std./Deep Metric & SAE Impact Socket Set	TL-517X	17	Combination Screwdriver Set
700107	1	3/8" Dr. Impact Universal Joint	HS-5610M	10	Metric Hex Screwdriver Set
TG-308S	8	3/8" Dr. 6pt. Std. SAE Swivel Impact Socket Set	HS-5612S	12	SAE Hex Screwdriver Set
TG-312M	12	3/8" Dr. 6pt. Std. Metric Swivel Impact Socket Set	TX-513T	13	Star Screwdriver Set
700108	1	1/2" Dr. Impact Universal Joint	TL-504A	4	Square Screwdriver Set
IE-2349	9	1/4", 3/8" & 1/2" Dr. Impact Extension Set	ND-012M	12	Metric Hex Nut Driver Set
CM-326S	26	3/8" Dr. 6pt. Std./Deep SAE Impact Socket Set	ND-007S	7	SAE Hex Nut Driver Set
CM-332M	32	3/8" Dr. 6pt. Std./Deep Metric Impact Socket Set	780256	1	24mm Adjustable Wrench, 200 mmL
IS-422S	22	1/2" Dr. 6pt. Std. SAE Impact Socket Set	HS-024M	24	Metric Combination Wrench Set
DI-422S	22	1/2" Dr. 6pt. Deep SAE Impact Socket Set	HS-016S	16	SAE Combination Wrench Set
IS-425M	25	1/2" Dr. 6pt. Std. Metric Impact Socket Set	DE-713M	13	Metric Double Ended Offset Ring Wrench Set
DI-425M	25	1/2" Dr. 6pt. Deep Metric Impact Socket Set	DE-708S	8	SAE Double Ended Offset Ring Wrench Set
280226P	1	1/4" Dr. Hinge Handle	HK-009MB	9	Metric Wobble Hex Wrench Set
282262	1	1/4" Dr. 72 Teeth Flex Head Ratchet	HK-009SB	9	SAE Wobble Hex Wrench Set
GS-244MS	44	1/4" Dr. 6pt. Std./Deep Metric & SAE Hand Socket Set	SK-010T	10	L-Shaped Tamperproof Star Wrench Set
380336P	1	3/8" Dr. Hinge Handle	OS-505SP	5	Offset Slotted & Phillips Screwdriver
380400	1	3/8" Dr. Speed Handle	782300	1	Heavy Duty Pipe Wrench, 300mmL
383363	1	3/8" Dr. 72 Teeth Flex Head Ratchet	CP-5804	4	General Purpose Plier Set
383338	1	3/8" Dr. 72 Teeth Flex Head Ratchet	RP-5504	4	Retaining Ring Plier Set
380371	1	1/4" & 3/8" Dr. Double Size Ratchet	530310RA	1	Straight Jaw Plier, 10"L
GS-347MS	47	3/8" Dr. 6pt. Std./Deep Metric & SAE Hand Socket Set	511003S	1	Straight Cut Aviation Snip, 250mmL
484464	1	1/2" Dr. 72 Teeth Flex Head Ratchet	590116	1	Claw Hammer 1 lbs./454g
480420	1	1/2" Dr. Speed Handle 420 mmL	590208	1	Ball Peen Hammer 1/2 lbs./227g
480446P	1	1/2" Dr. Hinge Handle	590216	1	Ball Peen Hammer 1 lbs./454g
480448P	1	1/2" Dr. Hinge Handle	590348	1	Drilling Hammer 3 lbs./1362g
TW-446MS	46	1/2" Dr. 12pt. Std. Metric & SAE Hand Socket Set	590416	1	Soft Face Hammer 1 lbs./454g
DS-422S	22	1/2" Dr. 6pt. Deep SAE Hand Socket Set	590524	1	Rubber Mallet 1-1/2 lbs./681g
DS-425M	25	1/2" Dr. 6pt. Deep Metric Hand Socket Set	PC-514S	14	SAE Punch & Chisel Set
TX-23414	14	1/4", 3/8" & 1/2" Dr. Star Hand Socket Set	CW-404MS	4	Metric & SAE Car Wheel Thin Wall Deep Impact Socket Set
TX-2353	53	1/4" & 3/8" Dr. Bit Socket Set	002034	1	Magnetic Parts Tray, Double
TX-246S	46	SAE Extra Long Screwdriver Bits With OMINDRIVE® Set	AT-B16	1	Telescoping Magnetic Pick-Up Tool
ID-414	14	1/2" Dr. Impact Driver Set	PB-5094	4	Pry Bar Set

150 kgs

MS-771TS 771pcs 1/4" 3/8" & 1/2" Dr. Metric & SAE Master Tool Set (with tool cabinet & tool chest)

- 1 **MS-771** 771pcs 1/4" 3/8" & 1/2" Dr. Metric & SAE Master Tool Set
- 1 **TS-710** 6 Drawer Top Tool Chest
- 1 **TS-748** 8 Drawer Side Tool Cabinet
- 1 **TS-796** 8 Drawer Roller Cabinet

395 kgs



Master Sets

Master Tool Sets

MS-215TS 215pcs 1/4", 3/8" & 1/2" Dr. Metric & SAE Tool Set

- 1 **MS-139MS** 139pcs
1/4", 3/8" & 1/2"Dr.
Metric & SAE Tool Set
- 1 **MS-041MS** 41pcs Metric & SAE
Combination &
Flare Nut Wrench Set
- 1 **MS-035MS** 35pcs Pliers &
Screwdriver Set
- 1 **TS-790** 10 Drawer Top Chest

82 kgs

NEW



Master Tool Sets

MS-221TS 221pcs 1/4" & 1/2" Dr. Metric Mechanic Tool Set

- 1 **MS-013SP** 13pcs
Slotted & Philips
Screwdriver Set
- 1 **MS-121M** 121pcs 1/4" Dr.
Metric Hand Socket
& Bit Set
- 1 **MS-437M** 37pcs 1/2" Dr. Metric
Hand Socket Set
- 1 **MS-024M** 24pcs Metric
Combination &
Box End Wrench Set
- 1 **MS-019** 19pcs Punch, Chisel
& Hammer Set
- 1 **MS-007P** 7pcs Pliers Set
- 1 **TS-244** 4 Drawer Top Chest

49 kgs

NEW



MS-215TA 215pcs 1/4", 3/8" & 1/2" Dr. Metric & SAE Tool Set

- 1 **MS-139MS** 139pcs
1/4", 3/8" & 1/2"Dr.
Metric & SAE Tool Set
- 1 **MS-041MS** 41pcs Metric & SAE
Combination &
Flare Nut Wrench Set
- 1 **MS-035MS** 35pcs Pliers &
Screwdriver Set
- 1 **TS-244** 4 Drawer Top Chest

59 kgs

NEW



Master Tool Sets

MS-243TS 243pcs 1/4" & 1/2" Dr. Metric Mechanic Tool Set

- 1 **MS-013SP** 13pcs Slotted & Philips Screwdriver Set
- 1 **MS-121M** 121pcs 1/4" Dr. Metric Hand Socket & Bit Set
- 1 **MS-437M** 37pcs 1/2" Dr. Metric Hand Socket Set
- 1 **MS-024M** 24pcs Metric Combination & Box End Wrench Set
- 1 **MS-019** 19pcs Punch, Chisel & Hammer Set
- 1 **MS-007P** 7pcs Pliers Set
- 1 **MS-008R** 8pcs Retaining Ring Pliers & Oil Filter Wrench Set
- 1 **MS-014A** 14pcs Combination Auto Repair Tool Kit
- 1 **TS-467P** 7 Drawer Roller Cabinet w/ Inter Lock

91 kgs

NEW



Master Tool Sets

MS-363TS 363pcs 1/4", 3/8" & 1/2" Dr. Metric Mechanic Tool Set

- 1 **MS-013SP** 13pcs Slotted & Philips Screwdriver Set
- 1 **MS-013T** 13pcs Star Screwdriver Set
- 1 **MS-121M** 121pcs 1/4" Dr. Metric Hand Socket & Bit Set
- 1 **MS-071M** 71pcs 3/8" Dr. Metric Hand Socket & Bit Socket Set
- 1 **MS-437M** 37pcs 1/2" Dr. Metric Hand Socket Set
- 1 **MS-442B** 42pcs 1/2" Dr. Bit Socket Set
- 1 **MS-020M** 20pcs Metric Combination Wrench
- 1 **MS-020B** 20pcs Metric Box End, Open End & E-Star Wrench Set
- 1 **MS-019** 19pcs Punch, Chisel & Hammer Set
- 1 **MS-007P** 7pcs Pliers Set
- 1 **TS-467P** 7 Drawer Roller Cabinet w/ Inter Lock

102 kgs

NEW



MS-480TS 480pcs 1/4", 3/8" & 1/2" Dr. Metric Mechanic Tool Set

- 1 MS-013SP** 13pcs Slotted & Philips Screwdriver Set
- 1 MS-013T** 13pcs Star Screwdriver Set
- 1 MS-121M** 121pcs 1/4" Dr. Metric Hand Socket & Bit Set
- 1 MS-071M** 71pcs 3/8" Dr. Metric Hand Socket & Bit Socket Set
- 1 MS-437M** 37pcs 1/2" Dr. Metric Hand Socket Set
- 1 MS-442B** 42pcs 1/2" Dr. Bit Socket Set
- 1 MS-020M** 20pcs Metric Combination Wrench
- 1 MS-020B** 20pcs Metric Box End, Open End & E-Star Wrench Set
- 1 MS-019** 19pcs Punch, Chisel & Hammer Set
- 1 MS-007P** 7pcs Pliers Set
- 1 MS-008R** 8pcs Retaining Ring Pliers & Oil Filter Wrench Set
- 1 MS-014A** 14pcs Combination Auto Repair Tool Kit
- 1 MS-435M** 35pcs 1/2" Dr. Metric Deep Hand Socket Set
- 1 MS-435I** 35pcs 1/2" Dr. Metric Deep Impact Socket Set
- 1 MS-025R** 25pcs Hex Screwdriver & Ratcheting Screwdriver Set
- 1 TS-244** 4 Drawer Top Chest
- 1 TS-467P** 7 Drawer Roller Cabinet w/ Inter Lock



150 kgs



NEW



Drive Size Index

1/4" Drive		
Adapters.....	11	Impact Adapters.....7
Air Ratchets.....	45	Impact Extensions.....7
Bit Holders.....	38	Impact Sockets & Sets...6-7
Bit Sockets & Sets... 29-30		Impact Thin Wall Sockets...6
Extensions & Sets.....	11	Impact Universal Joints...7
Flex Head Ratchet.....	11	Impact Wrenches.....47-48
Hand Sockets & Sets... 10-13		L-Handle.....23
Hand Accessories..... 10-11		Ratchets.....23
Hex Bit Sockets.....	29	Sliding T-Handle.....23
Hex Head Sockets.....	10	Star Bit Sockets.....28
Hinge Handle.....	11	Torque Extensions.....58
Impact Adapters.....	2	Torque Wrenches.....54
Impact Bit Holders.....	2	Triple Sq. Bit Sockets.....28
Impact Extensions.....	2	Universal Joints.....23
Impact Sockets & Sets.....	2	
Impact Universal Joints...2		
1/2" Drive		
Adapters.....	19	Adapters.....25
Air Ratchets.....	45	Bit Sockets & Sets.....28
Bit Holders.....	38	Extensions.....25
Bit Sockets & Sets... 34-35		Hand Sockets & Sets...24-25
Extensions & Sets..... 11,19		Hand Accessories.....24-25
Flex Head Ratchet.....	18	Hex Bit Sockets.....28
Hand Sockets & Sets... 17-21		Hex Head Drivers.....27
Hand Accessories..... 18-19		Hinge Handle.....24
Hex Bit Sockets.....	34	Impact Adapters.....8
Hex Head Drivers.....	27	Impact Extensions.....8
Hinge Handle.....	18	Impact Sockets & Sets...8-9
Impact Adapters.....	4	Impact Universal Joints...8
Impact Bit Holders.....	4	Impact Wrenches.....48
Impact Drivers.....	41	Ratchets.....24
Impact Extensions.....	4	Sliding T-Handle.....25
Impact Sockets & Sets...4-5		Torque Extensions.....58
Impact Swivel Socket Set...5		Torque Sockets.....59
Impact Universal Joints...4		Torque Wrenches.....54
Impact Wrenches..... 45-47		Universal Joints.....25
Pentacle Bit Sockets.....	34	
Philips Bit Sockets.....	34	
Philips Head Drivers.....	27	
Quick Release Ratchets...18		
Ratchets.....	18	
Ribe Bit Sockets.....	35	
Rotor Ratchets.....	18	
Sliding T-Handle.....	18	
Slotted Bit Sockets.....	34	
Slotted Head Drivers.....	27	
Spark Plugs Sockets.....	18	
Star Bit Sockets.....	34	
Star Hand Sockets.....	18	
Star Head Drivers.....	27	
T-Handle.....	18	
Tamperproof Star Bit Skt. 34		
Torque Extensions.....	58	
Torque Sockets.....	59	
Torque Wrenches.....	54	
Triple Sq. Bit Sockets.....	34	
Triple Sq. Head Driver.....	27	
Universal Joints.....	19	
Wobble Extensions.....	19	
Wobble Hex Bit Sockets...35		
3/8" Drive		
Adapters.....	15	
Air Ratchets.....	45	
Bit Holders.....	38	
Bit Sockets & Sets... 30-33		
Extensions & Sets.....	15	
Flex Head Ratchet.....	14	
Hand Sockets & Sets... 13-17		
Hand Accessories..... 18-19		
Hex Bit Sockets.....	30	
Hex Head Drivers.....	26	
Hinge Handle.....	14	
Impact Adapters.....	3	
Impact Bit Holders.....	3	
Impact Drivers.....	41	
Impact Extensions.....	3	
Impact Sockets & Sets.....	3	
Impact Swivel Socket Set...3		
Impact Universal Joints...3		
Impact Wrenches..... 45-46		
Pentacle Bit Sockets.....	31	
Philips Bit Sockets.....	30	
Philips Head Drivers.....	26	
Quick Release Ratchets...14		
Ratchets.....	14	
Ribe Bit Sockets.....	31	
Rotor Ratchets.....	14	
Sliding T-Handle.....	14	
Slotted Bit Sockets.....	30	
3/4" Drive		
Adapters.....	23	
Bit Sockets & Sets.....	28	
Extensions.....	23	
Hand Sockets & Sets...22-24		
Hand Accessories.....	23	
Hex Bit Sockets.....	28	
Hex Head Drivers.....	27	
Hinge Handle.....	23	

GENIUS TOOLS SINCE 1975

DISTRIBUTED BY: